

PINTI INOX S.p.A.
Via Antonini, 87
25068 Sarezzo (BS) Italia
Tel. +39 030 89351
Fax +39 030 8935250
+39 030 8901163
www.pinti.it
pintinox@pinti.it

PINTI INOX GMBH
DEUTSCHLAND
Römerstraße 91
73066 Utingen
Tel +49 07161 93343-0
Fax +49 07161 352789
www.pinti.de
info@pinti.de

PINTINOX / HORECA 2020

PINTINOX

HO

RE

CA

2020

PINTINOX

HO

RE

CA

2020



HOtellerie REstaurant CAtering

Il catalogo HO.RE.CA. è la raccolta più esauriente di prodotti in acciaio inossidabile destinati alla moderna ristorazione. Il capitolo posate offre l'immagine in scala 1/1 dei pezzi per un'immediata visualizzazione. Lo sviluppo in cucina segue rigorosamente il percorso del cibo dalla preparazione al trasporto sino alla presentazione.

The HO.RE.CA. catalogue is the most exhaustive collection of stainless steel products for today's catering. The catalogue dedicated to cutlery shows a 1/1 scale reproduction of the pieces for quick view. The kitchen development follows the food journey from preparation to transport and packaging.

Le catalogue HO.RE.CA. est la collection la plus complète de produits en acier inox destinés à la restauration moderne. Le chapitre "Couverts" présente l'image des pièces à l'échelle 1/1 pour une visualisation immédiate. Le développement à la cuisine suit rigoureusement le parcours des aliments, de la préparation à la présentation en passant par le transport.

Der HO.RE.CA.-Katalog ist die ausführlichste Sammlung an Produkten aus nichtrostendem Stahl, bestimmt für das moderne Gaststättengewerbe. Das Kapitel Besteck zeigt die massstabgetreue Abbildung der Teile für eine sofortige Darstellung. Die Entwicklung in der Küche verfolgt rigoros den Weg der Speisen von der Vorbereitung über den Transport bis zum Servieren.

El catálogo HO.RE.CA. es la recopilación más completa de los productos de acero inoxidable dirigidos a la restauración moderna. El capítulo "Cubiertos" presenta la imagen de las piezas a escala 1/1 para una visualización inmediata. El desarrollo en la cocina sigue rigurosamente el recorrido de los alimentos, de la preparación a la presentación pasando por el transporte.



INDICE

Index

POSATE	21
<i>Cutlery - Couverts - Bestecke - Cubiertos</i>	
COTTURA	169
<i>Cooking - Cuisson - Küchen - Cocción</i>	
GASTRONORM	223
<i>Gastronorm - Gastronorm - Gastronorm - Gastronorm</i>	
PREPARAZIONE	255
<i>Preparation - La préparation - Vorbereitung - Preparación</i>	
PRESENTAZIONE	265
<i>Presentation - Présentation - Präsentation - Presentación</i>	
UTENSILI	279
<i>Tools - Utensiles - Zubehör - Utensilios</i>	
BAR/GELATERIA	313
<i>Bar/Icecream - Bar/Crème glacée - Bar/Eis - Bar/Helado</i>	
BUFFET	341
<i>Buffet - Buffet - Buffet - Buffet</i>	
RICAMBI	359
<i>Spare parts - Pièces de rechanges - Ersatzteile - Piezas de repuesto</i>	
ESPOSITORI	368
<i>Display - Présentoir - Wandaussteller - Expositor</i>	
SEZIONE ESPLICATIVA	379
<i>Technical Information - Information Technique - Technische Informationen - Información Técnica</i>	
LUXURY COLLECTION	386
INDICE GENERALE	403
<i>Index - Index - Inhaltsverzeichnis - Índice</i>	

LA STORIA

History

L'azienda **Pinti Inox S.p.A.** è localizzata in un'area "la Valtrompia" che da sempre è stata dedicata alla lavorazione dei metalli. Dai tempi degli antichi Romani, le miniere di ferro, i monti boscosi per la produzione di carbone di legna, e la forza motrice dell'acqua dei torrenti hanno favorito l'industria metallurgica. Già dal Medio Evo la zona era conosciuta come centro di produzione di armi e lame. Nel 1929, dopo la grande crisi, Giacomo Pinti decide di mettersi in proprio e costruire la sua prima officina in Lumezzane per la lavorazione di posate in ottone cromato e coltelleria. Successivamente l'azienda è cresciuta fino a diventare un'importante entità industriale. In questi anni di storia l'azienda si è evoluta ed è diventata leader nel settore della posateria. Oggi siamo alla terza generazione, con ogni membro della famiglia a presiedere un ruolo chiave nell'azienda. Lo sforzo di modernizzazione ha portato la società a dotarsi di automatismi industriali ed al rinnovamento delle gamme di prodotti. È dal 1929 che la nostra azienda è leader nella posateria ed offre numerose linee complete (classiche, moderne, di tendenza). Le gamme si abbinano perfettamente a tutti gli stili delle porcellane esistenti per creare un insieme armonioso sulle tavole eleganti. Le linee sono sempre complete di tutte le pezzature necessarie ed alcune versioni hanno anche il coltello manico cavo, lama forgiata.

***Pinti Inox S.p.A.** is situated in an area known as "Valtrompia" which has always been linked strongly with the metal-working sector. Since the days of the Ancient Romans, the iron mines and tree-covered mountains for the production of coal, joined by the driving force of the water flowing along the rivers, have favoured the metallurgy industry. The area was well known for the production of weapons and blades as early as the Middle Ages. In 1929, after the great recession, Giacomo Pinti decided to set up his own business, opening his first workshop in Lumezzane, where he produced chrome-plated brass cutlery and knives. The company subsequently grew and developed into an important industrial concern. Nowadays the third generation of the family runs the company. Each member oversees a key role in the company. Considerable modernisation has led the company to acquire industrial automated systems and fully renew the product ranges. Our company has been a leader in the cutlery market since 1929. We offer a variety of complete ranges in classic, modern and fashionable styles that make a perfect match with all styles of tableware and go together to create a harmonious ensemble for elegant tabletop. Our lines offer all the accessories you may require to beautifully set your table and some of them have hollow handle knives with forged blades.*



L'AZIENDA

The company

Oggi l'azienda vanta un'entità produttive e due unità distributive:

- 1.SAREZZO (ITALY): Pintinox S.p.A. con lo stabilimento di Sarezzo che occupa 15.000 m² coperti, in cui vi sono le produzioni di: tutti gli stampi ed attrezzature del gruppo, posateria con cicli completi, posateria forgiata, coltelleria, vasellame e accessori, pentolame professionale, linee buffet ed articoli professionali.
- 2.GERMANY: In Germania la società Pinti inox GmbH si occupa della distribuzione sul territorio tedesco.

Today the company has two production units and three distribution units:

- 1.SAREZZO (ITALY): *Pintinox S.p.A. with the Sarezzo plant, occupying an indoor area of 15,000 m², housing production of: all the group's moulds and equipment, complete cycle cutlery, forged cutlery, knives, tableware and accessories, professional pans, buffet line and professional articles.*
- 2.GERMANY: *In Germany, Pinti inox GmbH handles distribution throughout German territory.*



DNV

Quality Certificate

MANAGEMENT SYSTEM CERTIFICATE

Certificato no./Certificate No.:
CERT-07553-2000-AQ-MIL-SINCERT

Data prima emissione/Initial date:
14 dicembre 2000

Validità:/Valid:
04 marzo 2018 - 04 marzo 2021

Si certifica che il sistema di gestione di/This is to certify that the management system of

PINTI INOX S.p.A. Sede Legale ed Operativa

Via Antonini, 87 - 25068 Sarezzo (BS) - Italy

È conforme ai requisiti della norma per il Sistema di Gestione Qualità/
has been found to conform to the Quality Management System standard:

ISO 9001:2015

Questa certificazione è valida
per il seguente campo applicativo:

**Progettazione e produzione di: posateria,
pentolame per uso domestico, alberghiero e
catering ed oggetti in acciaio inox per la
tavola e la cucina (EA 17)**

This certificate is valid
for the following scope:

**Design and manufacture of: cutlery, cookware
for domestic, hotels and catering uses,
stainless steel tableware and kitchen
accessories (EA 17)**

Luogo e Data/Place and date:
Vimercate (MB), 01 marzo 2018



SGQ N° 003 A ENAS N° 009 F
SGA N° 003 D IRO N° 003 B
SGE N° 007 H PRG N° 004 C
SUK N° 004 F SSI N° 002 G

Membro di MLA EA per gli schemi di accreditamento
SGQ, SGA, PRO, PMS, ISP, GHG, LNB e LAT di HLA IAF
per gli schemi di accreditamento SGQ, SGA, SSI, PSM
e PRD e di HRA, SAC per gli schemi di accreditamento
LAB, MRO, LAT e ISP

Per l'Organismo di Certificazione/
For the Certification Body
DNV GL - Business Assurance
Via Energy Park, 14 - 20871 Vimercate
(MB) - Italy

Zeno Beltrami
Management Representative

La validità del presente Certificato è subordinata al rispetto delle condizioni contenute nel Contratto di Certificazione/
Lack of fulfilment of conditions as set out in the Certification Agreement may render this Certificate invalid.
DNV GL Business Assurance Italia S.r.l., Via Energy Park, 14 - 20871 Vimercate (MB) - Italy. TEL:039 68 99 905. www.dnvgl.it

PINTI1929

MADE IN ITALY

E' la linea più prestigiosa che racchiude 90 anni di storia. Identifica la gamma più importante della ns. produzione. In cui qualità, ricerca e innovazione si fondono in prodotti unici ed esemplari.

It is the most prestigious line that includes 90 years of history. *This brand identifies the most important range of our production: quality, design, research and innovation come together in unique products.*



PINTINOX

MADE IN ITALY

E' il nostro Marchio, la nostra identità.

I prodotti raggruppati sotto questo marchio sono tutti i prodotti di uso quotidiano, strumenti e accessori che caratterizzano maggiormente la nostra azienda che ottimizzano il rapporto qualità prezzo nella vita di tutti i giorni.

This is our brand , our identity.

The products grouped under this brand are for a daily use. Tools and accessories that most characterize our company willing to produce value for money products for everyday life.







FINITURE SPECIALI

Special finished

ON
DEMAND

TREASURE - GOLD, BRONZE, TITANIUM, HONEY, COPPER, GREY, TOTAL BLACK

Titanio, bronzo e oro: le nostre posate diventano dei pezzi unici, inimitabili e indimenticabili. Grazie a sofisticate tecnologie all'avanguardia, trasformiamo le nostre più belle posate classiche e di design in veri e propri tesori per la tavola. Le posate Treasure sono rivestite in PVD (acronimo di Physical Vapour Deposition), depositi metallici superficiali, sotto forma di film molto sottili, ottenuti con tecnologie altamente innovative che permettono di ottenere durezza superficiali molto elevate. A ciò si aggiunge la possibilità di ottenere diversi tipi di colorazioni senza alterare la lucentezza tipica dell'acciaio né l'atocissità del prodotto, che può quindi entrare in contatto con gli alimenti. Ordine minimo 240 pz assortiti per colore. In ogni caso non si accettano ordini inferiori ai 36 pz per pezzatura e a 6 pz per i servire di ciascun modello.

Titanium, bronze, gold: our cutlery comes alive and becomes unique and unforgettable. Thanks to our sophisticated and avant-garde technologies, our most beautiful and classic cutlery becomes design cutlery and a real treasure for the table. The Treasure cutlery describes a variety of vacuum deposition methods used to deposit this films by the condensation of vaporized form of the desired film material onto various workpiece surfaces. The result is a higher hardness surface and the possibility to obtain different colors without altering the polished steel. Minimum order quantity 240 pcs mixed per colour. In any case orders under 36 pcs per item and 6 pcs serving cutlery will be not accepted.

ALCHIMIQUE - GOLD, BRONZE, TITANIUM

Alchimique una preziosa finitura PVD che conferisce tre tonalità esclusive e pregiate alle posate della Collezione Stone Washed: Gold, gioielli sulla tavola; Bronze, metallo naturale; Titanium, la forza unita allo stile. Ordine minimo 240 pz assortiti per colore. In ogni caso non si accettano ordini inferiori ai 36 pz per pezzatura e a 6 pz per i servire di ciascun modello.

Alchimique is a precious PVD coating made in 3 different special colors for an astonish Stone Washed Cutlery Collection. Gold, jewellery on the table. Bronze, pure metal. Titanium, power and style. Minimum order quantity 240 pcs mixed per colour. In any case orders under 36 pcs per item and 6 pcs serving cutlery will be not accepted.

STONE WASHED

La Collezione Stone Washed nasce dal desiderio di esaltare la propria tavola in perfetto stile retrò con articoli ricercati e di ottima fattura. I prodotti, attentamente selezionati nelle gamme Pintinox e Pinti 1929, sono antichizzati con uno speciale processo detto Stone Wash: il risultato è un prodotto unico nell'aspetto e qualitativamente perfetto. Per garantire un elevato standard di qualità, tutti i coltelli sono stati riaffilati dopo avere subito il trattamento Stone Wash. Tutte le serie proposte sono complete di tutte le pezzature e già disponibili per la vendita. Ordine minimo 120 pz per pezzatura e 12 pz per i servire di ciascun modello.

The Stone Washed Collection is a selection from Pintinox cutlery assortment. The aim is to offer quality cutlery to the customers willing to create a retro atmosphere when laying their tables. This cutlery has been stone washed to create a vintage effect on the stainless steel, intentionally creating a finish with a non-uniform appearance; each piece is therefore unique. All our knives have been resharpened after the Stone Wash process to ensure the usual high quality standard. Minimum order quantity 120 pcs per item and 12 pcs serving cutlery.

MYSTIQUE

Finitura raffinata ed elegante, delicatamente ruvida al tatto. Grazie a un processo di sabbiatura profonda ogni articolo è resistente ad urti e abrasioni ed è adatto all'utilizzo anche nella ristorazione professionale. Ordine minimo 60 pz per pezzatura e 12 pz per i servire di ciascun modello.

Sandblasted stainless steel for an elegant mat finishing. Thanks to a deep sandblasting process, every item is strike and abrasion resistant and suitable for using in Horeca. Minimum order quantity 60 pcs per item and 12 pcs serving cutlery.

ARGENTATURA - SILVER PLATED EN1=10 MIC.

L'argentatura della nostra posateria si basa su 50 anni di esperienza e su una tecnologia avanzata. Il materiale base è l'acciaio al 18/10, sul quale viene applicato uno strato di argento spesso 10 micron tramite processo galvanico. Sulle parti esposte ad un'usura maggiore, come le punte della forchetta ed i punti di appoggio, viene apportato un doppio strato al fine di garantire all'argentatura una durata omogenea nel tempo. Sebbene possibile si sconsiglia il lavaggio in lavastoviglie. Ordine minimo 240 pz assortiti. In ogni caso non si accettano ordini inferiori ai 36 pz per pezzatura e a 6 pz per i servire.

Our silver plating process for cutlery is based on 50 years of experience and state-of-art technology. The basic material is stainless steel 18/10 to which a 10-micron layer of silver is applied by galvanisation. The parts most exposed to wear, such as the tips and resting points are given a double layer to guarantee long-lasting plating. Thick plate silverware can't be washed in the dishwasher. Minimum order quantity 240 pcs assorted. In any case orders under 36 pcs per item and 6 pcs serving cutlery will be not accepted.

ARGENTATURA 30 MICRON SU RICHIESTA - SILVER PLATING 30 MICRON ON REQUEST

Ordine minimo 240 pz assortiti. In ogni caso non si accettano ordini inferiori ai 36 pz per pezzatura e a 6 pz per i servire. - *Minimum order quantity 240 pcs assorted. In any case orders under 36 pcs per item and 6 pcs serving cutlery will be not accepted.*

Aggiungere al prezzo dello sfuso - Add to the price of the unpacked item - Ajouter au prix des pièces en vrac - Dem Preis des nicht verpackten Artikels - Adicionar al precio del artículo no acondicionado

Per griglie Finiture Speciali vedi pag 376 / For Special Finished tables see page 376

LISTINO FINITURE SPECIALI PER VARIANTI ON DEMAND

Special Finished on demand price list

Cod.	Descrizione - Description	TREASURE				ALCHIMIQUE			Argentatura Silver Plated (10 µ) Euro
		Gold Euro	Bronze Titanium Euro	Honey Copper Grey Tot. Black Euro	Stone Washed Euro	Gold Euro	Bronze Titanium Euro	Mystique Euro	
01	Cucch. tavola - Table spoon - Cuiller de table - Tafelöffel - Cuchara mesa	5,20	8,30	4,90	0,64	5,84	8,94	1,10	7,00
02	Forch. tavola - Table fork - Fourchette de table - Tafelgabel - Tenedor mesa	5,20	8,30	4,90	0,64	5,84	8,94	1,10	5,90
03	Colt. tavola - Table knife - Couteau de table - Tafelmesser - Cuchillo mesa	5,20	8,30	4,90	0,74	5,94	9,04	1,10	7,00
CC	Colt. tavola m.v. lama forg. - Table knife H.H and forged blade - Couteau de table à m.c. et lame forgée - Tafelholhftmesser mit geschmiedeter Klinge - Cuchillo mesa con m.h. y hoja forjada	-	-	-	0,74	-	-	1,10	7,80
04	Cucch. frutta - Dessert spoon - Cuiller dessert - Dessertlöffel - Cuchara postre	5,20	8,30	4,20	0,64	5,84	8,94	1,00	6,20
05	Forch. frutta - Dessert fork - Fourchette dessert - Dessertgabel - Tenedor postre	5,20	8,30	4,20	0,64	5,84	8,94	1,00	5,30
06	Colt. frutta - Dessert knife - Couteau dessert - Dessertmesser - Cuchillo postre	5,20	8,30	4,20	0,74	5,94	9,04	1,00	7,20
CD	Colt. frutta m.v. lama forg. - Dessert knife H.H and forged blade - Couteau dessert à m.c. et lame forgée - Dessertholhftmesser mit geschmiedeter Klinge - Cuchillo postre con m.h. y hoja forjada	-	-	-	0,74	-	-	1,00	7,20
07	Cucch. caffè - Tea-coffee spoon - Cuiller à café - Kaffeelöffel - Cuchara café	4,30	5,70	3,30	0,54	4,84	6,24	0,92	4,00
08	Cucch. moka - Moka spoon - Cuiller à moka - Mokkalöffel - Cuchara moka	3,80	5,70	3,10	0,54	4,34	6,24	0,92	3,00
10	Mestolo - Soup ladle - Louche - Suppenschöpfer - Cazo sopa	20,90	24,90	16,60	1,70	22,60	26,60	1,40	28,90
11	Cucchiavone - Serving spoon - Cuiller de service - Gemüselöffel - Cuchara servir	8,80	11,30	8,40	0,96	9,76	12,26	1,30	8,40
12	Forchettone - Serving fork - Fourchette de service - Serviergabel - Tenedor servir	8,80	11,30	8,40	0,96	9,76	12,26	1,30	8,40
13	Mestolo salsa - Sauce ladle - Louche à sauce - Saucenlöffel - Cacillo salsa	20,90	24,90	16,60	1,70	22,60	26,60	1,40	12,00
15	Forch. insalata - Salad fork - Fourchette à salade - Salatgabel - Tenedor ensalada	8,80	11,30	8,40	0,96	9,76	12,26	1,30	8,40
16	Forch. dolce 4 spine - Pastry fork - Fourchette gateau - Kuchengabel 4 Zinken - Tenedor postre 4 p as	5,20	8,30	4,20	0,64	5,84	8,94	1,00	5,30
17	Forch. 3 spine - Pastry fork - Fourchette à gateau - Kuchengabel 3 Zinken - Tenedor postre 3 púas	5,20	8,30	3,30	0,64	5,84	8,94	0,92	3,60
18	Cucch. dolce - Tea-cake spoon - Cuiller à gateau - Kuchenlöffel - Cuchara postre	5,20	8,30	4,20	0,64	5,84	8,94	1,00	4,40
19	Colt. dolce - Pastry knife - Couteau à gateau - Kuchenmesser - Cuchillo postre	5,20	8,30	4,20	0,74	5,94	9,04	1,00	6,60
20	Pala torta - Cake server - Pelle à tarte - Tortenheber - Pala pastel	17,50	22,80	15,70	0,96	18,46	23,76	1,30	12,00
CR	Cucch. crema - Cream spoon - Cuiller à crème - Sahnelöffel - Cuchara crema	5,20	8,30	4,20	0,64	5,84	8,94	1,00	4,40
39	Cucch. brodo - Soup spoon - Cuiller à soupe - Fleischbrühelöffel - Cuchara caldo	5,20	8,30	4,20	0,64	5,84	8,94	1,10	6,30
22	Paletta gelato - Ice cream spoon - Cuiller à glace - Eislöffel - Cuchara para helado	5,20	8,30	4,20	0,64	5,84	8,94	1,10	3,70
36	Cucch. bibita - Long drink spoon - Cuiller à drink - Limolöffel - Cuchara refresco	8,80	11,30	8,40	0,96	9,76	12,26	1,10	4,70
28	Forch. pesce - Fish fork - Fourchette à poisson - Fischgabel - Tenedor pescado	5,20	8,30	4,90	0,64	5,84	8,94	1,10	5,30
29	Colt. pesce - Fish knife - Couteau à poisson - Fischmesser - Cuchillo pescado	5,20	8,30	4,90	0,64	5,84	8,94	1,10	5,30
30	Forch. pesce servire - Fish serving fork - Fourchette à servir poisson - Fischserviergabel - Tenedor servir pescado	8,80	11,30	8,40	0,96	9,76	12,26	1,30	9,00
31	Colt. pesce servire - Fish serving knife - Couteau à servir poisson - Fischserviermesser - Cuchillo servir pescado	8,80	11,30	8,40	0,96	9,76	12,26	1,30	9,00

PUNZONATURA

Marking

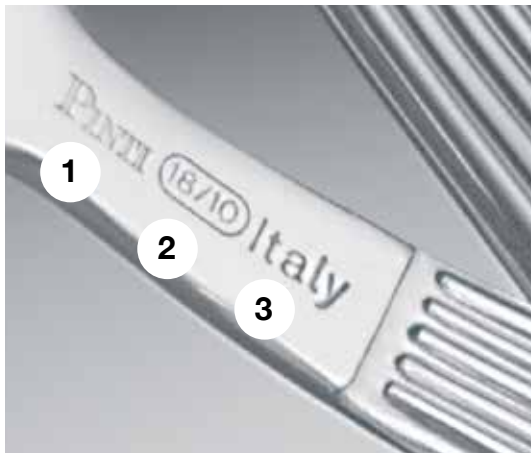

La punzonatura consiste nel simbolo di identificazione delle parti ed ha il seguente significato:

1. Nome del costruttore
2. Materiale utilizzato
3. Paese d'origine del costruttore

Marking is the identification mark of pieces and means:

1. Name of manufacturer
2. Material
3. Manufacturer's place of origin



Punzonatura Meccanica:

Cod. S0001000 - Si ottiene quando il logo viene stampato durante la produzione dell'articolo. Non vengono accettati ordini inferiori ai 1200 pz x pezzatura. Il costo per l'attrezzatura macchina e per la realizzazione dei punzoni personalizzati è di 500,00 Euro netti per pezzatura che verranno aggiunti a fondo fattura.

Mechanical Stamped:

Cod. S0001000 - This process is reached when a logo is stamped during the production of the article. The minimum order accepted is 1200 pieces for item. The net cost to equip the machine and to realize personalized punches is 500,00 Euros each item and it will be added at the end of the invoice.



Punzonatura Laser:

quando il logo viene applicato con questa tecnica non vengono accettati ordini per quantitativi inferiori ai 240 pz. per pezzatura di posateria. Euro 0,20 netti al pezzo (Spese a punzone Euro 60,00 netti).

Laser Stamping:

when laser stamping is used, we only accept orders for more than 240 pcs for each cutlery item. Euro 0,20 net per pce (Net tooling costs Euro 60,00).





P O S A T E

C u t l e r y

C o u v e r t s

B e s t e c k e

C u b i e r t o s

PINTI1929 Relais
Chateaux

PINTINOX Hotel
Division



Per alimenti
Suitable for foodstuffs
Apte au contact avec les aliments
Für Lebensmittel
Apto para alimentos



Garantito per lavastoviglie
Dishwasher safe
Inalterable dans lave-vaisselle
Spelmaschinenfest
Apto para lavavajillas



POSATE 1:1

Size cutlery 1:1

Come scegliere una posata.

È la cosa più facile del mondo!

Basta definire il piatto e facilmente si trova l'abbinamento più efficace, sfogliando il catalogo. Le foto delle posate sono in scala 1/1: accostando il piatto alla fotografia della posata si può verificare immediatamente l'aspetto scenico e definire la scelta.

How to choose cutlery.

Nothing could be easier!

All you have to do is select a plate and you can then find the best match by simply flicking through our catalogue. The photos of our cutlery are on a 1/1 scale which means that by placing your plate next to the photo of the cutlery you can immediately see how well they go together and make your choice.

Comment choisir un couvert.

C'est la chose la plus simple du monde!

Il suffit de définir l'assiette et de feuilleter le catalogue pour trouver aisément l'association la plus efficace. Les photos des couverts sont à l'échelle 1/1: en associant la vaisselle à la photographie du couvert, vous pouvez vérifier immédiatement l'effet et définir votre choix.

Und so wählen Sie ein Besteck aus.

Es ist kinderleicht!

Sie brauchen nur einen Teller festzulegen und schon erscheint beim Blättern im Katalog die wirksamste Zusammenstellung. Das Besteck ist 1:1 abgebildet: Wenn Sie einen Teller neben das Bild stellen, können Sie sofort feststellen, ob dieses passt, und Ihre Wahl treffen.

Cómo elegir un cubierto.

¡Es la cosa más fácil del mundo!

Basta describir el plato y se encuentra siempre la combinación más eficaz, hojeando el catálogo. Las fotos de los cubiertos son en escala 1/1: acercando el plato a la fotografía del cubierto se puede comprobar inmediatamente el efecto y definir la elección.

Cod.	cm	Euro
0001	20,8	11,32
0002	21,1	11,32
0003	23,5	11,32
00CC	-	-
00CA	-	-
00L3	-	-
0067	-	-
0004	18,4	10,42
0005	18,4	10,42
0006	21,3	10,60
00L6	-	-
00CD	-	-
00CB	-	-
0007	15,5	9,28
0008	12,4	9,08
0010	27,2	26,66
0011	23,8	16,68
0012	24,0	16,68
0013	17,5	14,00
0014	-	-
0015	-	-
0016	-	-
0059	-	-
00AW	-	-
0017	16,4	10,26
0018	-	-
00L9	-	-
0019	-	-
0020	25,2	22,38
0052	-	-
00CR	-	-
0009	-	-
0022	-	-
0023	-	-
0025	-	-
00CS	-	-
0026	-	-
0027	-	-
00FM	-	-
0035	-	-
0036	-	-
0038	-	-
0039	18,2	10,64
00AT	-	-
0028	18,6	11,20
0029	20,6	11,20
0030	-	-
0031	-	-

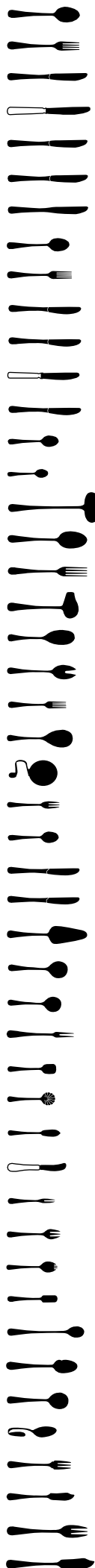

BRAMANTE

0780

PINTI1929

inox 18/10
forgiato - forged



ELLADE

0790

PINTI1929

inox 18/10

forgiato - forged



Cod.	cm	Euro
0001	21,2	11,10
0002	21,1	11,10
0003	24,0	11,52
00CC	-	-
00CA	-	-
00L3	-	-
0067	-	-
0004	18,7	10,22
0005	18,4	10,22
0006	21,7	10,60
00L6	-	-
00CD	-	-
00CB	-	-
0007	15,5	9,12
0008	12,5	8,90
0010	27,2	26,14
0011	24,4	16,36
0012	24,5	16,36
0013	18,9	13,72
0014	-	-
0015	-	-
0016	-	-
0059	-	-
00AW	-	-
0017	16,4	9,88
0018	-	-
00L9	-	-
0019	-	-
0020	24,6	21,96
0052	-	-
00CR	-	-
0009	-	-
0022	-	-
0023	-	-
0025	-	-
00CS	-	-
0026	-	-
0027	-	-
00FM	-	-
0035	-	-
0036	-	-
0038	-	-
0039	17,9	10,54
00AT	-	-
0028	18,6	10,98
0029	20,6	10,98
0030	-	-
0031	-	-

Cod.	cm	Euro
0001	20,4	8,66
0002	20,3	8,66
0003	23,5	6,74
00CC	-	-
00CA	-	-
00L3	-	-
0067	-	-
0004	-	-
0005	18,3	7,66
0006	21,2	5,82
00L6	-	-
00CD	-	-
00CB	-	-
0007	14,3	5,46
0008	11,4	5,34
0010	27,7	18,96
0011	23,1	11,42
0012	24,1	11,42
0013	17,2	13,20
0014	-	-
0015	-	-
0016	-	-
0059	-	-
00AW	-	-
0017	15,3	5,76
0018	-	-
00L9	-	-
0019	-	-
0020	24,1	11,98
0052	-	-
00CR	-	-
0009	-	-
0022	-	-
0023	-	-
0025	-	-
00CS	-	-
0026	-	-
0027	-	-
00FM	-	-
0035	-	-
0036	-	-
0038	-	-
0039	18,4	7,66
00AT	-	-
0028	18,4	8,10
0029	20,1	8,32
0030	-	-
0031	-	-

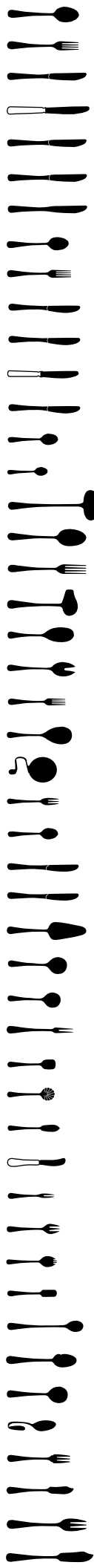

HERMITAGE

0870

PINTI1929

inox 18/10
forgiato - *forged*



PRIVILEGE

0510

PINTI1929

inox 18/10

mm 4,0



Cod.	cm	Euro
0001	21,0	6,48
0002	21,4	6,48
0003	23,0	7,54
00CC	-	-
00CA	-	-
00L3	-	-
0067	-	-
0004	18,5	6,38
0005	18,7	6,38
0006	21,0	7,18
00L6	-	-
00CD	-	-
00CB	-	-
0007	14,5	4,48
0008	12,5	4,38
0010	27,8	17,68
0011	23,6	9,88
0012	24,0	9,88
0013	18,5	11,10
0014	-	-
0015	-	-
0016	-	-
0059	-	-
00AW	-	-
0017	16,6	4,94
0018	-	-
00L9	-	-
0019	-	-
0020	26,0	12,74
0052	-	-
00CR	-	-
0009	-	-
0022	-	-
0023	-	-
0025	-	-
00CS	-	-
0026	-	-
0027	-	-
00FM	-	-
0035	-	-
0036	-	-
0038	-	-
0039	18,2	6,28
00AT	-	-
0028	18,9	6,70
0029	21,2	6,70
0030	-	-
0031	-	-

Cod.	cm	Euro
0001	20,5	6,22
0002	20,7	6,22
0003	23,5	6,40
00CC	-	-
00CA	-	-
00L3	-	-
0067	-	-
0004	18,1	5,76
0005	18,3	5,76
0006	20,5	5,92
00L6	-	-
00CD	-	-
00CB	-	-
0007	13,9	2,90
0008	12,0	2,66
0010	29,5	19,94
0011	24,0	9,88
0012	24,0	9,88
0013	17,3	11,66
0014	-	-
0015	-	-
0016	-	-
0059	-	-
00AW	-	-
0017	15,5	3,24
0018	-	-
00L9	-	-
0019	-	-
0020	24,3	11,10
0052	-	-
00CR	-	-
0009	-	-
0022	-	-
0023	-	-
0025	-	-
00CS	-	-
0026	-	-
0027	-	-
00FM	-	-
0035	-	-
0036	-	-
0038	-	-
0039	-	-
00AT	-	-
0028	18,2	5,76
0029	20,7	5,92
0030	-	-
0031	-	-

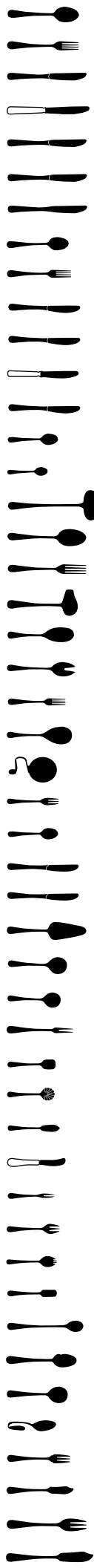

OCTAVIA 0860

PINTI1929

inox 18/10
mm 4,0





Cod.	cm	Euro
0001	20,9	4,64
0002	20,9	4,64
0003	24,0	7,18
00CC	24,5	11,64
00CA	-	-
00L3	-	-
0067	-	-
0004	18,8	4,48
0005	18,6	4,48
0006	21,5	7,08
00L6	-	-
00CD	21,5	11,52
00CB	-	-
0007	14,5	2,30
0008	12,0	2,30
0010	28,2	16,26
0011	24,2	8,02
0012	24,0	8,02
0013	17,8	9,32
0014	-	-
0015	-	-
0016	-	-
0059	-	-
00AW	-	-
0017	15,9	2,98
0018	-	-
00L9	-	-
0019	-	-
0020	24,8	11,22
0052	-	-
00CR	-	-
0009	-	-
0022	-	-
0023	-	-
0025	-	-
00CS	-	-
0026	-	-
0027	-	-
00FM	-	-
0035	-	-
0036	-	-
0038	-	-
0039	17,7	4,48
00AT	-	-
0028	18,7	4,84
0029	21,0	4,84
0030	-	-
0031	-	-

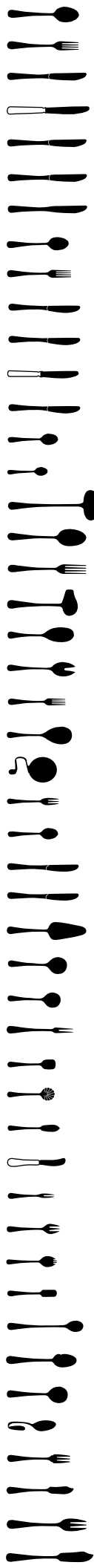

VITTORIALE

1640

PINTI1929

inox 18/10
mm 3,0



SPATEN

1630

PINTI1929

inox 18/10

mm 3,0



Cod.	cm	Euro
0001	20,9	4,64
0002	20,9	4,64
0003	24,0	7,18
00CC	24,5	11,64
00CA	-	-
00L3	-	-
0067	-	-
0004	18,8	4,48
0005	18,6	4,48
0006	21,5	7,08
00L6	-	-
00CD	21,5	11,52
00CB	-	-
0007	14,5	2,30
0008	12,0	2,30
0010	27,5	16,26
0011	24,2	8,02
0012	24,0	8,02
0013	17,8	9,32
0014	-	-
0015	-	-
0016	-	-
0059	-	-
00AW	-	-
0017	16,0	2,98
0018	-	-
00L9	-	-
0019	-	-
0020	24,8	11,22
0052	-	-
00CR	-	-
0009	-	-
0022	-	-
0023	-	-
0025	-	-
00CS	-	-
0026	-	-
0027	-	-
00FM	-	-
0035	-	-
0036	-	-
0038	-	-
0039	-	-
00AT	-	-
0028	18,7	4,84
0029	21,0	4,84
0030	-	-
0031	-	-

Cod.	cm	Euro
0001	23,2	4,48
0002	23,2	4,48
0003	24,5	6,60
00CC	-	-
00CA	-	-
00L3	-	-
0067	-	-
0004	20,0	4,38
0005	20,1	4,38
0006	21,4	6,40
00L6	-	-
00CD	-	-
00CB	-	-
0007	17,2	2,84
0008	11,1	2,74
0010	29,0	16,16
0011	26,0	7,36
0012	26,0	7,36
0013	15,0	9,22
0014	-	-
0015	-	-
0016	-	-
0059	-	-
00AW	-	-
0017	17,2	3,20
0018	-	-
00L9	-	-
0019	-	-
0020	23,0	11,22
0052	-	-
00CR	-	-
0009	-	-
0022	-	-
0023	-	-
0025	-	-
00CS	-	-
0026	-	-
0027	-	-
00FM	-	-
0035	-	-
0036	-	-
0038	-	-
0039	-	-
00AT	-	-
0028	20,0	4,74
0029	22,2	4,74
0030	-	-
0031	-	-

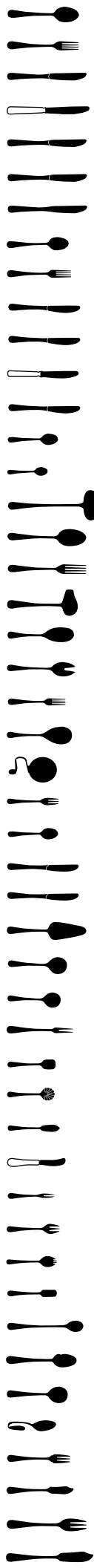

CONCEPT 0450

PINTI1929

inox 18/10
mm 3,0



CONCEPT 0450



Cod. 0011
cm 26,0
cucchiaine servire
serving spoon



Cod. 0012
cm 26,0
forchettone servire
serving fork



Cod. 0003
cm 24,5
coltello tavola
table knife



Cod. 0001
cm 23,2
cucchiaino tavola
table spoon



Cod. 0002
cm 23,2
forchetta tavola
table fork



Cod. 0029
cm 22,2
coltello pesce
fish knife



Cod. 0004
cm 20,0
cucchiaino frutta
dessert spoon



Cod. 0005
cm 20,1
forchetta frutta
dessert fork



Cod. 0006
cm 21,4
coltello frutta
dessert knife



Cod. 0007
cm 17,2
cucchiaino caffè
tea/coffee spoon



Cod. 0028
cm 20,0
forchetta pesce
fish fork



Cod. 0008
cm 11,1
cucchiaino moka
moka spoon



Cod. 0017
cm 17,2
forchetta dolce
pastry fork



Cod. 0010
cm 29,0
mestolo
soup ladle



Cod. 0020
cm 23,0
pala torta
cake server



Cod. 0013
cm 15,0
mestolo salsa
sauce ladle

Cod.	cm	Euro
0001	21,0	4,18
0002	21,0	4,18
0003	23,5	5,50
00CC	-	-
00CA	-	-
00L3	-	-
0067	-	-
0004	18,0	4,08
0005	18,1	4,08
0006	21,2	5,16
00L6	-	-
00CD	-	-
00CB	-	-
0007	14,9	3,12
0008	11,0	3,02
0010	-	-
0011	-	-
0012	-	-
0013	-	-
0014	-	-
0015	-	-
0016	-	-
0059	-	-
00AW	-	-
0017	16,5	3,12
0018	-	-
00L9	-	-
0019	-	-
0020	-	-
0052	-	-
00CR	-	-
0009	-	-
0022	-	-
0023	-	-
0025	19,6	4,18
00CS	-	-
0026	-	-
0027	-	-
00FM	-	-
0035	-	-
0036	-	-
0038	19,2	3,92
0039	18,1	3,86
00AT	-	-
0028	19,0	4,12
0029	21,7	4,12
0030	-	-
0031	-	-

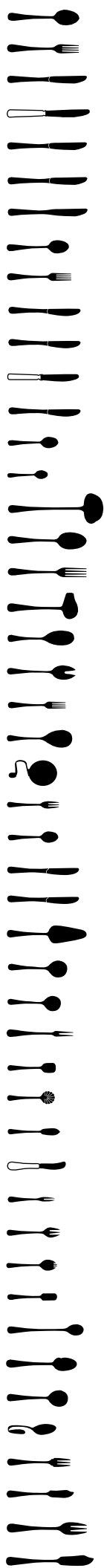

INFINITO 0850

PINTI1929

inox 18/0

forgiato/forged

Design *Daniele Ardisson*

NICKEL
FREE



085000FB cm 18,0 Euro 3,76 cucch. alta cucina alta cucina spoon

INFINITO 0850



Cod. 0001
cm 21,0
cucchiaio tavola
table spoon



Cod. 0002
cm 21,0
forchetta tavola
table fork



Cod. 0003
cm 23,5
coltello tavola
table knife



Cod. 0038
cm 22,1
cucchiaio gourmet
gourmet spoon



Cod. 0028
cm 19,0
forchetta pesce
fish fork



Cod. 0029
cm 21,7
coltello pesce
fish knife



Cod. 0039
cm 18,1
cucchiaio brodo
soup spoon



Cod. 0005
cm 18,1
forchetta frutta
dessert fork



Cod. 0006
cm 21,2
coltello frutta
dessert knife



Cod. 00FB
cm 18,0
cucchiaio alta cucina
alta cucina spoon



Cod. 0017
cm 16,5
forchetta dolce
pastry fork



Cod. 0025
cm 19,6
coltello spalmaburro
butter spreader



Cod. 0004
cm 18,0
cucchiaio frutta
dessert spoon



Cod. 0007
cm 14,9
cucchiaino caffè
tea/coffee spoon



Cod. 0008
cm 11,0
cucchiaino moka
moka spoon

Cod.	cm	Euro
0001	23,0	3,96
0002	23,0	3,96
0003	24,0	6,60
00CC	-	-
00CA	-	-
00L3	-	-
0067	-	-
0004	20,0	3,96
0005	19,9	3,96
0006	21,0	6,40
00L6	-	-
00CD	-	-
00CB	-	-
0007	17,0	2,30
0008	10,9	2,30
0010	29,0	16,26
0011	26,0	7,36
0012	26,0	7,36
0013	15,0	9,32
0014	-	-
0015	-	-
0016	-	-
0059	-	-
00AW	-	-
0017	17,0	2,98
0018	-	-
00L9	-	-
0019	-	-
0020	23,0	11,22
0052	-	-
00CR	15,0	2,30
0009	-	-
0022	-	-
0023	-	-
0025	-	-
00CS	-	-
0026	-	-
0027	-	-
00FM	-	-
0035	-	-
0036	-	-
0038	-	-
0039	-	-
00AT	-	-
0028	19,9	4,28
0029	21,8	4,28
0030	-	-
0031	-	-

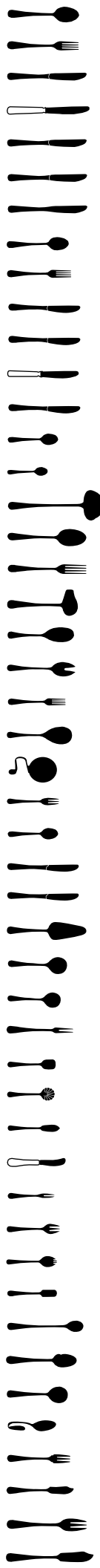

TECNA 0470

PINTI1929

inox 18/10
mm 3,0



TECNA 0470



Cod. 0011
cm 26,0
cucchiaine servire
serving spoon



Cod. 0012
cm 26,0
forchettone servire
serving fork



Cod. 0003
cm 24,0
coltello tavola
table knife



Cod. 0001
cm 23,0
cucchiaino tavola
table spoon



Cod. 0002
cm 23,0
forchetta tavola
table fork



Cod. 0029
cm 21,8
coltello pesce
fish knife



Cod. 0004
cm 20,0
cucchiaino frutta
dessert spoon



Cod. 0005
cm 19,9
forchetta frutta
dessert fork



Cod. 0006
cm 21,0
coltello frutta
dessert knife



Cod. 0007
cm 17,0
cucchiaino caffè
tea/coffee spoon



Cod. 0028
cm 19,9
forchetta pesce
fish fork



Cod. 00CR
cm 15,0
cucchiaino crema
cream spoon



Cod. 0017
cm 17,0
forchetta dolce
pastry fork



Cod. 0008
cm 10,9
cucchiaino moka
moka spoon



Cod. 0010
cm 29,0
mestolo
soup ladle



Cod. 0020
cm 23,0
pala torta
cake server



Cod. 0013
cm 15,0
mestolo salsa
sauce ladle

Cod.	cm	Euro
0001	20,8	3,96
0002	20,9	3,96
0003	22,5	6,60
00CC	-	-
00CA	-	-
00L3	-	-
0067	-	-
0004	18,7	3,96
0005	18,7	3,96
0006	20,5	6,40
00L6	-	-
00CD	-	-
00CB	-	-
0007	14,6	2,20
0008	11,8	2,10
0010	28,0	16,26
0011	25,5	7,36
0012	25,5	7,36
0013	17,4	9,32
0014	-	-
0015	-	-
0016	-	-
0059	-	-
00AW	-	-
0017	15,4	2,98
0018	-	-
00L9	-	-
0019	-	-
0020	23,0	11,22
0052	-	-
00CR	-	-
0009	-	-
0022	-	-
0023	-	-
0025	-	-
00CS	-	-
0026	-	-
0027	-	-
00FM	-	-
0035	-	-
0036	-	-
0038	-	-
0039	-	-
00AT	-	-
0028	18,1	4,28
0029	19,8	4,28
0030	-	-
0031	-	-

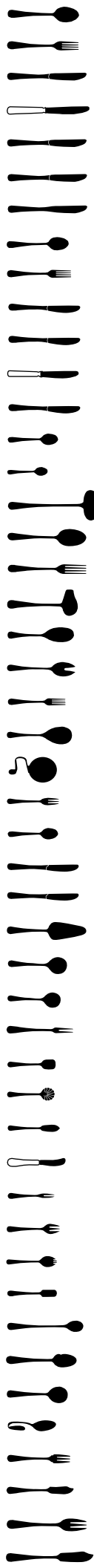

SWING 0880

PINTI1929

inox 18/10
mm 3,0



088000FA 14,6 Euro 2,30 cucch. antipasto piccolo *small starter spoon*
 088000FB 18,7 Euro 3,30 cucch. antipasto grande *large starter spoon*



Cod.	cm	Euro
0001	23,0	3,96
0002	23,0	3,96
0003	24,5	6,60
00CC	-	-
00CA	-	-
00L3	-	-
0067	-	-
0004	19,8	3,96
0005	19,7	3,96
0006	21,4	6,40
00L6	-	-
00CD	-	-
00CB	-	-
0007	16,5	2,30
0008	11,0	2,30
0010	29,0	18,34
0011	26,0	8,24
0012	26,0	8,24
0013	14,9	9,98
0014	26,0	9,44
0015	26,0	9,44
0016	-	-
0059	-	-
00AW	-	-
0017	17,0	2,98
0018	-	-
00L9	-	-
0019	-	-
0020	23,1	11,22
0052	-	-
00CR	-	-
0009	-	-
0022	-	-
0023	-	-
0025	-	-
00CS	-	-
0026	-	-
0027	-	-
00FM	-	-
0035	-	-
0036	-	-
0038	-	-
0039	-	-
00AT	-	-
0028	19,7	4,28
0029	21,8	4,28
0030	-	-
0031	-	-

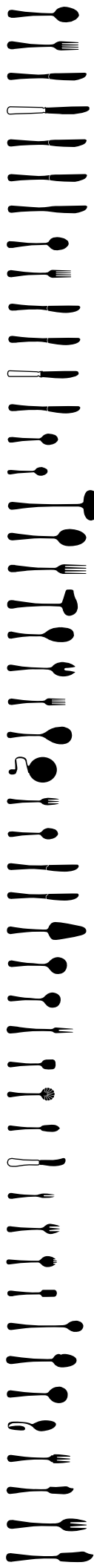

OLIVIA 0490

PINTI1929

inox 18/10
mm 3,0



OLIVIA 0490



Cod. 0011
cm 26,0
cucchiaine servire
serving spoon



Cod. 0012
cm 26,0
forchettone servire
serving fork



Cod. 0003
cm 24,5
coltello tavola
table knife



Cod. 0014
cm 26,0
cucchiaino insalata
salad spoon



Cod. 0015
cm 26,0
forchetta insalata
salad fork



Cod. 0029
cm 21,8
coltello pesce
fish knife



Cod. 0001
cm 23,0
cucchiaino tavola
table spoon



Cod. 0002
cm 23,0
forchetta tavola
table fork



Cod. 0006
cm 21,4
coltello frutta
dessert knife



Cod. 0004
cm 19,8
cucchiaino frutta
dessert spoon



Cod. 0005
cm 19,7
forchetta frutta
dessert fork



Cod. 0007
cm 16,5
cucchiaino caffè
tea/coffee spoon



Cod. 0028
cm 19,7
forchetta pesce
fish fork



Cod. 0008
cm 11
cucchiaino moka
moka spoon



Cod. 0017
cm 17,0
forchetta dolce
pastry fork



Cod. 0010
cm 29,0
mestolo
soup ladle



Cod. 0020
cm 23,1
pala torta
cake server



Cod. 0013
cm 14,9
mestolo salsa
sauce ladle

Cod.	cm	Euro
0001	20,6	3,96
0002	20,6	3,96
0003	24,1	6,60
00CC	25,3	11,64
00CA	-	-
00L3	-	-
0067	23,0	6,60
0004	17,8	3,96
0005	18,5	3,96
0006	22,0	6,40
00L6	-	-
00CD	22,5	11,52
00CB	-	-
0007	14,6	2,20
0008	11,8	2,10
0010	28,0	16,26
0011	23,5	7,36
0012	23,6	7,36
0013	17,5	9,32
0014	-	-
0015	-	-
0016	-	-
0059	-	-
00AW	-	-
0017	15,1	2,98
0018	-	-
00L9	-	-
0019	17,7	5,12
0020	24,0	11,22
0052	-	-
00CR	-	-
0009	-	-
0022	13,7	2,20
0023	-	-
0025	-	-
00CS	-	-
0026	-	-
0027	-	-
00FM	-	-
0035	-	-
0036	-	-
0038	20,4	3,84
0039	17,9	3,84
00AT	-	-
0028	18,0	4,28
0029	19,4	4,28
0030	23,0	7,36
0031	25,0	7,36

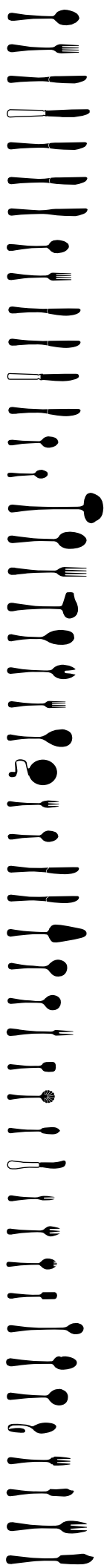

BAGUETTE

0830

PINTI1929

inox 18/10
mm 3,0





Cod.	cm	Euro
0001	20,6	3,96
0002	20,6	3,96
0003	24,0	6,60
00CC	25,2	11,64
00CA	-	-
00L3	-	-
0067	22,8	6,60
0004	17,9	3,96
0005	18,5	3,96
0006	21,6	6,40
00L6	-	-
00CD	21,6	11,52
00CB	-	-
0007	14,6	2,20
0008	11,8	2,10
0010	28,0	16,26
0011	23,5	7,36
0012	23,8	7,36
0013	17,9	9,32
0014	-	-
0015	22,8	8,90
0016	-	-
0059	-	-
00AW	-	-
0017	15,0	2,98
0018	-	-
00L9	-	-
0019	17,6	5,12
0020	24,0	11,22
0052	-	-
00CR	15,2	3,74
0009	19,7	3,96
0022	13,6	2,20
0023	13,5	2,30
0025	15,0	2,78
00CS	-	-
0026	15,3	2,54
0027	15,5	3,20
00FM	-	-
0035	12,1	2,74
0036	22,0	3,20
0038	20,4	3,84
0039	17,8	3,84
00AT	-	-
0028	18,0	4,28
0029	19,6	4,28
0030	22,5	7,36
0031	25,0	7,36

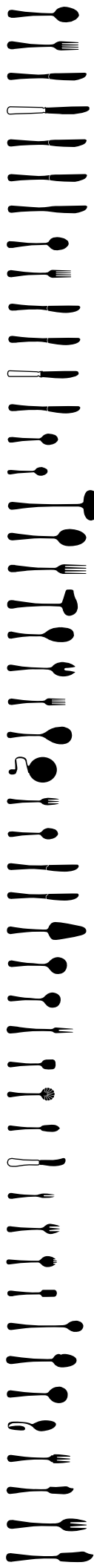

BYRON 0800

PINTI1929

inox 18/10
mm 3,0



BYRON 0800



Cod. 0011
cm 23,5
cucchiaione servire
serving spoon



Cod. 0036
cm 22,0
cucchiaino bibita
long drink spoon



Cod. 0001
cm 20,6
cucchiaino tavola
table spoon



Cod. 0038
cm 20,4
cucchiaino gourmet
gourmet spoon



Cod. 0004
cm 17,9
cucchiaino frutta
dessert spoon



Cod. 0039
cm 17,8
cucchiaino brodo
soup spoon



Cod. 00CR
cm 15,2
cucchiaino crema
cream spoon



Cod. 0007
cm 14,6
cucchiaino caffè
tea/coffee spoon



Cod. 0022
cm 13,6
paletta gelato
ice cream spoon



Cod. 0035
cm 12,1
sessola zucchero
sugar spoon



Cod. 0008
cm 11,8
cucchiaino moka
moka spoon



Cod. 0012
cm 23,8
forchettone servire
serving fork



Cod. 0015
cm 22,8
forchetta insalata
salad fork



Cod. 0030
cm 22,5
forchetta pesce servire
fish serving fork



Cod. 0002
cm 20,6
forchetta tavola
table fork



Cod. 0009
cm 19,7
forchetta carne
meat fork



Cod. 0005
cm 18,5
forchetta frutta
dessert fork



Cod. 0028
cm 18,0
forchetta pesce
fish fork



Cod. 0027
cm 15,5
forchetta ostriche
oyster fork



Cod. 0026
cm 15,3
forchetta lumache
snail fork



Cod. 0017
cm 15,0
forchetta dolce
pastry fork



Cod. 0031
cm 25,0
coltello pesce servire
fish serving knife



Cod. 00CC
cm 25,2
colt. tav manico vuoto
table knife H. H.



Cod. 0003
cm 24,0
coltello tavola
table knife



Cod. 0067
cm 22,8
coltello bistecca
steak knife



Cod. 00CD
cm 21,6
colt. frutta manico vuoto
dessert knife H. H.



Cod. 0006
cm 21,6
coltello frutta
dessert knife



Cod. 0029
cm 19,6
coltello pesce
fish knife



Cod. 0019
cm 17,6
coltello dolce
pastry knife



Cod. 0025
cm 15,0
spalma burro
butter spreader



Cod. 0010
cm 28,0
mestolo
soup ladle



Cod. 0020
cm 24,0
pala torta
cake server



Cod. 0013
cm 17,9
mestolo salsa
sauce ladle



Cod. 0023
cm 13,5
cucchiaino formaggio
grated-cheese spoon

<i>Cod.</i>	<i>cm</i>	Euro
0001	20,8	3,96
0002	20,6	3,96
0003	23,6	6,60
00CC	24,9	11,64
00CA	-	-
00L3	-	-
0067	-	-
0004	18,1	3,96
0005	18,2	3,96
0006	21,2	6,40
00L6	-	-
00CD	22,2	11,52
00CB	-	-
0007	14,6	2,20
0008	11,0	2,10
0010	27,2	16,26
0011	24,1	7,36
0012	24,0	7,36
0013	17,0	9,32
0014	-	-
0015	-	-
0016	-	-
0059	-	-
00AW	-	-
0017	15,5	2,98
0018	-	-
00L9	-	-
0019	-	-
0020	24,0	11,22
0052	-	-
00CR	-	-
0009	-	-
0022	14,2	2,20
0023	-	-
0025	-	-
00CS	-	-
0026	-	-
0027	-	-
00FM	-	-
0035	-	-
0036	-	-
0038	-	-
0039	17,2	3,84
00AT	-	-
0028	18,8	4,28
0029	20,1	4,28
0030	-	-
0031	-	-

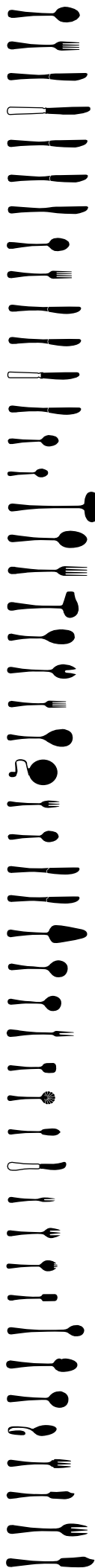

PALLADIUM 0590

PINTI1929

inox 18/10
mm 3,0



EUCLIDE

0480

PINTI1929

inox 18/10

mm 3,0



Cod.	cm	Euro
0001	22,0	3,96
0002	22,0	3,96
0003	24,0	6,60
00CC	-	-
00CA	-	-
00L3	-	-
0067	-	-
0004	-	-
0005	19,3	3,96
0006	21,0	6,40
00L6	-	-
00CD	-	-
00CB	-	-
0007	15,8	2,30
0008	11,0	2,30
0010	29,0	16,26
0011	25,0	7,36
0012	25,0	7,36
0013	-	-
0014	-	-
0015	-	-
0016	-	-
0059	-	-
00AW	-	-
0017	-	-
0018	-	-
00L9	-	-
0019	-	-
0020	-	-
0052	-	-
00CR	-	-
0009	-	-
0022	-	-
0023	-	-
0025	-	-
00CS	-	-
0026	-	-
0027	-	-
00FM	-	-
0035	-	-
0036	-	-
0038	-	-
0039	-	-
00AT	-	-
0028	-	-
0029	-	-
0030	-	-
0031	-	-

Cod.	cm	Euro
0001	20,4	3,96
0002	20,6	3,96
0003	23,2	6,60
00CC	24,5	11,64
00CA	-	-
00L3	-	-
0067	-	-
0004	17,7	3,96
0005	18,4	3,96
0006	21,0	6,40
00L6	-	-
00CD	21,3	11,52
00CB	-	-
0007	14,5	2,20
0008	11,9	2,10
0010	27,7	16,26
0011	23,5	7,36
0012	23,7	7,36
0013	17,4	9,32
0014	-	-
0015	22,8	8,90
0016	-	-
0059	23,8	9,98
00AW	-	-
0017	15,0	2,98
0018	-	-
00L9	-	-
0019	17,7	5,12
0020	24,0	11,22
0052	-	-
00CR	15,5	3,74
0009	19,5	3,96
0022	13,6	2,20
0023	13,5	2,30
0025	15,0	2,78
00CS	18,7	10,08
0026	15,4	2,54
0027	15,5	3,20
00FM	12,5	2,42
0035	12,0	2,74
0036	22,0	3,20
0038	20,4	3,84
0039	17,7	3,84
00AT	-	-
0028	17,8	4,28
0029	19,5	4,28
0030	22,6	7,36
0031	25,1	7,36

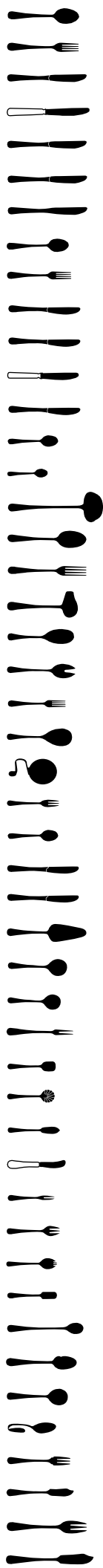

PITAGORA 0810

PINTI1929

inox 18/10
mm 3,0



07600067 Euro 6,62 cm 23,0 colt. bist. profess. *profess. meat knife.*

PITAGORA 0810



Cod. 0059
cm 23,8
cucchiaione risotto
rice spoon



Cod. 0011
cm 23,5
cucchiaione servire
servicing spoon



Cod. 0036
cm 22,0
cucchiaino bibita
long drink spoon



Cod. 0001
cm 20,4
cucchiaio tavola
table spoon



Cod. 0038
cm 20,4
cucchiaio gourmet
gourmet spoon



Cod. 0004
cm 17,7
cucchiaio frutta
dessert spoon



Cod. 0039
cm 17,7
cucchiaio brodo
soup spoon



Cod. 00CR
cm 15,5
cucchiaio crema
cream spoon



Cod. 0007
cm 14,5
cucchiaino caffè
tea/coffee spoon



Cod. 0022
cm 13,6
paletta gelato
ice cream spoon



Cod. 0035
cm 12,0
sessola zucchero
sugar spoon



Cod. 0008
cm 11,9
cucchiaino moka
moka spoon



Cod. 0012
cm 23,7
forchettone servire
servicing fork



Cod. 0015
cm 22,8
forchetta insalata
salad fork



Cod. 0030
cm 22,6
forchetta pesce servire
fish serving fork



Cod. 0002
cm 20,6
forchetta tavola
table fork



Cod. 0009
cm 19,5
forchetta carne
meat fork



Cod. 0005
cm 18,4
forchetta frutta
dessert fork



Cod. 0028
cm 17,8
forchetta pesce
fish fork



Cod. 0027
cm 15,5
forchetta ostriche
oyster fork



Cod. 0026
cm 15,4
forchetta lumache
snail fork



Cod. 0017
cm 15,0
forchetta dolce
pastry fork



Cod. 00FM
cm 12,5
forchetta molluschi
shellfish fork



Cod. 0031
cm 25,1
coltello pesce servire
fish serving knife



Cod. 00CC
cm 24,5
colt. tav manico vuoto
table knife H. H.



Cod. 0003
cm 23,2
coltello tavola
table knife



Cod. 00CD
cm 21,3
colt. frutta manico vuoto
dessert knife H. H.



Cod. 0006
cm 21,0
coltello frutta
dessert knife



Cod. 0029
cm 19,5
coltello pesce
fish knife



Cod. 00CS
cm 18,7
colt. burro manico vuoto
butter spreader H. H.



Cod. 0019
cm 17,7
coltello dolce
pastry knife



Cod. 0025
cm 15,0
spalma burro
butter spreader



Cod. 0010
cm 27,7
mestolo
soup ladle



Cod. 0020
cm 24,0
pala torta
cake server



Cod. 0013
cm 17,4
mestolo salsa
sauce ladle



Cod. 0023
cm 13,5
cucchiaio formaggio
grated-cheese spoon

Cod.	cm	Euro
0001	20,8	3,96
0002	20,7	3,96
0003	24,0	6,60
00CC	23,8	11,64
00CA	-	-
00L3	-	-
0067	23,0	6,60
0004	17,5	3,96
0005	17,7	3,96
0006	21,5	6,40
00L6	-	-
00CD	20,6	11,52
00CB	-	-
0007	14,5	2,20
0008	11,8	2,10
0010	28,0	16,26
0011	23,5	7,36
0012	23,8	7,36
0013	18,0	9,32
0014	-	-
0015	-	-
0016	-	-
0059	-	-
00AW	-	-
0017	16,7	2,98
0018	-	-
00L9	-	-
0019	-	-
0020	23,2	11,22
0052	-	-
00CR	-	-
0009	-	-
0022	-	-
0023	-	-
0025	-	-
00CS	-	-
0026	-	-
0027	-	-
00FM	-	-
0035	-	-
0036	-	-
0038	-	-
0039	17,3	3,84
00AT	-	-
0028	19,5	4,28
0029	21,3	4,28
0030	-	-
0031	-	-

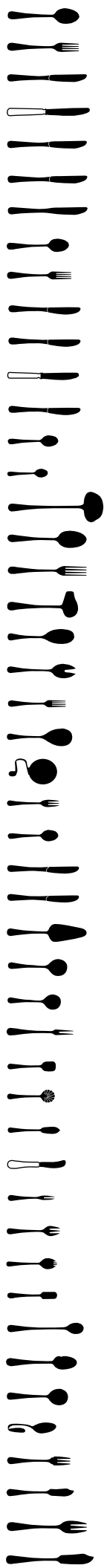

LEONARDO 0500

PINTI1929

inox 18/10
mm 3,0





Cod.	cm	Euro
0001	20,8	4,08
0002	20,8	4,08
0003	23,5	6,60
00CC	23,8	11,64
00CA	-	-
00L3	-	-
0067	23,6	6,60
0004	18,7	4,08
0005	18,7	4,08
0006	21,15	6,40
00L6	-	-
00CD	21,5	11,52
00CB	-	-
0007	14,7	2,54
0008	10,7	2,30
0010	27,4	16,26
0011	23,5	7,92
0012	23,8	7,92
0013	17,6	9,44
0014	-	-
0015	-	-
0016	-	-
0059	-	-
00AW	-	-
0017	15,5	2,74
0018	-	-
00L9	-	-
0019	-	-
0020	23,5	12,08
0052	-	-
00CR	-	-
0009	-	-
0022	-	-
0023	-	-
0025	-	-
00CS	-	-
0026	-	-
0027	-	-
00FM	-	-
0035	-	-
0036	-	-
0038	-	-
0039	18,1	3,96
00AT	-	-
0028	18,7	3,96
0029	19,8	3,96
0030	-	-
0031	-	-

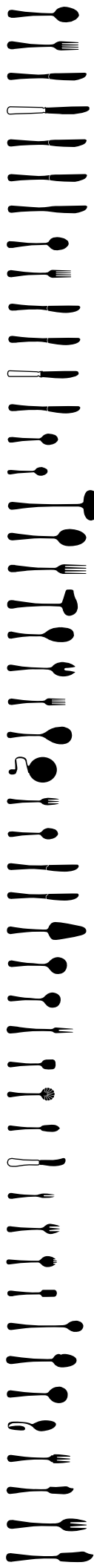

MILLENIUM 2270

PINTINOX

inox 18/10
mm 4,0



RITZ 2280

PINTINOX

inox 18/10
mm 4,0



Cod.	cm	Euro
0001	20,8	4,08
0002	20,8	4,08
0003	23,5	6,60
00CC	24,0	11,64
00CA	-	-
00L3	-	-
0067	22,8	6,60
0004	17,8	4,08
0005	18,1	4,08
0006	21,15	6,40
00L6	-	-
00CD	21,5	11,52
00CB	-	-
0007	14,3	2,54
0008	11,1	2,30
0010	27,5	16,26
0011	24,0	7,92
0012	24,0	7,92
0013	17,0	9,44
0014	-	-
0015	-	-
0016	-	-
0059	-	-
00AW	-	-
0017	14,8	2,74
0018	-	-
00L9	-	-
0019	-	-
0020	23,6	12,08
0052	-	-
00CR	-	-
0009	-	-
0022	13,8	2,54
0023	-	-
0025	-	-
00CS	-	-
0026	-	-
0027	-	-
00FM	-	-
0035	-	-
0036	19,5	2,98
0038	-	-
0039	17,8	3,96
00AT	-	-
0028	19,0	3,96
0029	19,7	3,96
0030	-	-
0031	-	-

Cod.	cm	Euro
0001	20,1	3,40
0002	20,1	3,40
0003	22,7	5,92
00CC	25,0	11,64
00CA	-	-
00L3	-	-
0067	-	-
0004	17,1	3,30
0005	17,1	3,30
0006	20,2	5,82
00L6	-	-
00CD	22,5	11,52
00CB	-	-
0007	14,6	1,88
0008	11,8	1,88
0010	28,0	15,38
0011	23,1	6,48
0012	23,6	6,48
0013	16,5	8,24
0014	-	-
0015	-	-
0016	-	-
0059	-	-
00AW	-	-
0017	14,8	2,10
0018	-	-
00L9	-	-
0019	-	-
0020	22,7	10,66
0052	-	-
00CR	-	-
0009	-	-
0022	-	-
0023	-	-
0025	-	-
00CS	-	-
0026	-	-
0027	-	-
00FM	-	-
0035	-	-
0036	-	-
0038	-	-
0039	16,9	3,20
00AT	-	-
0028	19,4	3,74
0029	20,9	3,74
0030	-	-
0031	-	-

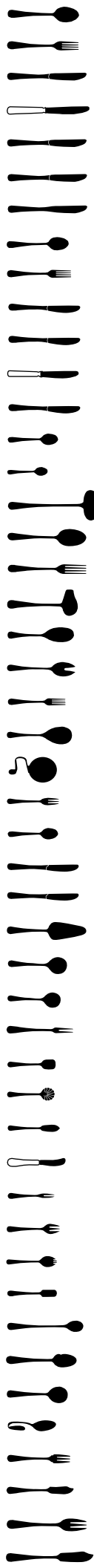

SETTECENTO 2050

PINTINOX

inox 18/10
mm 3,0



STILE

















































2400

PINTINOX

inox 18/10

mm 4,0



	Cod.	cm	Euro
	0001	21,0	3,38
	0002	21,0	3,38
	0003	22,5	5,40
	00CC	-	-
	00CA	-	-
	00L3	-	-
	0067	-	-
	0004	18,0	3,36
	0005	18,0	3,36
	0006	19,2	5,16
	00L6	-	-
	00CD	-	-
	00CB	-	-
	0007	14,7	2,22
	0008	11,0	2,20
	0010	29,0	17,64
	0011	26,0	7,92
	0012	26,0	7,92
	0013	-	-
	0014	-	-
	0015	-	-
	0016	-	-
	0059	-	-
	00AW	-	-
	0017	15,2	2,64
	0018	-	-
	00L9	-	-
	0019	-	-
	0020	-	-
	0052	-	-
	00CR	-	-
	0009	-	-
	0022	-	-
	0023	-	-
	0025	-	-
	00CS	-	-
	0026	-	-
	0027	-	-
	00FM	-	-
	0035	-	-
	0036	-	-
	0038	-	-
	0039	-	-
	00AT	-	-
	0028	19,1	3,80
	0029	20,5	3,80
	0030	-	-
	0031	-	-

Cod.	cm	Euro
0001	20,8	3,34
0002	20,8	3,34
0003	23,0	5,60
00CC	-	-
00CA	-	-
00L3	-	-
0067	-	-
0004	18,7	3,34
0005	18,7	3,34
0006	21,15	5,60
00L6	-	-
00CD	-	-
00CB	-	-
0007	14,4	1,76
0008	11,6	1,76
0010	29,0	14,86
0011	24,0	5,98
0012	23,5	5,98
0013	18,8	6,78
0014	-	-
0015	-	-
0016	-	-
0059	-	-
00AW	-	-
0017	15,3	2,22
0018	-	-
00L9	-	-
0019	-	-
0020	24,0	7,44
0052	-	-
00CR	-	-
0009	-	-
0022	-	-
0023	-	-
0025	-	-
00CS	-	-
0026	-	-
0027	-	-
00FM	-	-
0035	-	-
0036	-	-
0038	-	-
0039	-	-
00AT	-	-
0028	18,7	3,34
0029	19,8	3,42
0030	-	-
0031	-	-

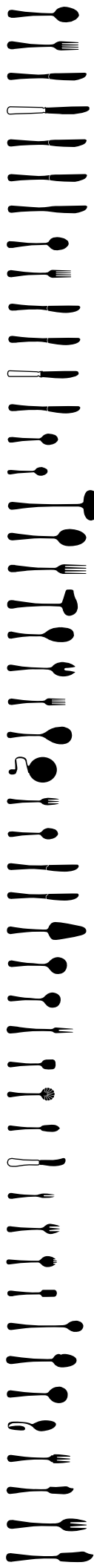

ROMANINO 0650

PINTINOX

inox 18/10
mm 3,5





Cod.	cm	Euro
0001	20,4	3,26
0002	20,4	3,26
0003	23,0	4,44
00CC	-	-
00CA	-	-
00L3	-	-
0067	-	-
0004	18,0	3,14
0005	18,0	3,14
0006	20,0	4,44
00L6	-	-
00CD	-	-
00CB	-	-
0007	13,7	2,36
0008	11,0	2,24
0010	-	-
0011	-	-
0012	-	-
0013	-	-
0014	-	-
0015	-	-
0016	-	-
0059	-	-
00AW	-	-
0017	15,4	2,48
0018	-	-
00L9	-	-
0019	-	-
0020	-	-
0052	-	-
00CR	-	-
0009	-	-
0022	-	-
0023	-	-
0025	16,0	3,78
00CS	-	-
0026	-	-
0027	-	-
00FM	-	-
0035	-	-
0036	18,0	3,12
0038	-	-
0039	19,0	3,08
00AT	-	-
0028	-	-
0029	20,5	3,18
0030	-	-
0031	-	-

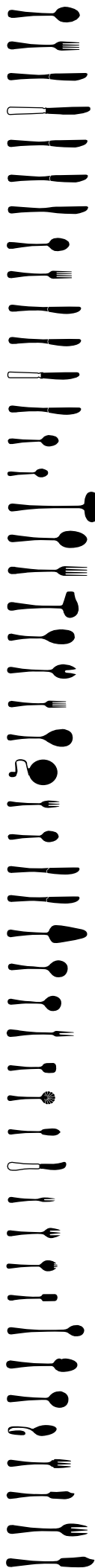

TRUMPET 2070

PINTINOX

inox 18/0

forgiato - forged

Design Daniele Ardisson

NICKEL
FREE



BERNINI 2060

PINTINOX

inox 18/10

mm 3,0



Cod.	cm	Euro
0001	20,0	3,20
0002	20,0	3,20
0003	22,5	5,60
00CC	25,0	11,64
00CA	-	-
00L3	-	-
0067	-	-
0004	17,1	3,20
0005	17,1	3,20
0006	20,0	5,60
00L6	-	-
00CD	24,4	11,52
00CB	-	-
0007	14,3	1,88
0008	11,5	1,88
0010	26,5	15,38
0011	23,1	6,48
0012	23,5	6,48
0013	16,5	8,24
0014	-	-
0015	22,8	8,02
0016	-	-
0059	-	-
00AW	-	-
0017	15,0	2,10
0018	-	-
00L9	-	-
0019	-	-
0020	22,7	10,66
0052	-	-
00CR	-	-
0009	-	-
0022	-	-
0023	-	-
0025	-	-
00CS	-	-
0026	-	-
0027	-	-
00FM	-	-
0035	-	-
0036	-	-
0038	-	-
0039	-	-
00AT	-	-
0028	19,4	3,62
0029	20,9	3,62
0030	-	-
0031	-	-

Cod.	cm	Euro
0001	21,2	3,20
0002	21,0	3,20
0003	23,0	5,60
00CC	-	-
00CA	-	-
00L3	-	-
0067	-	-
0004	18,1	3,20
0005	18,0	3,20
0006	20,0	5,60
00L6	-	-
00CD	-	-
00CB	-	-
0007	15,1	1,98
0008	11,1	1,98
0010	29,0	17,68
0011	24,0	6,92
0012	24,0	6,92
0013	16,5	9,44
0014	-	-
0015	-	-
0016	-	-
0059	-	-
00AW	-	-
0017	17,0	2,84
0018	-	-
00L9	-	-
0019	-	-
0020	24,0	10,66
0052	-	-
00CR	-	-
0009	-	-
0022	-	-
0023	-	-
0025	-	-
00CS	-	-
0026	-	-
0027	-	-
00FM	-	-
0035	-	-
0036	-	-
0038	-	-
0039	-	-
00AT	-	-
0028	19,5	3,20
0029	21,5	3,20
0030	-	-
0031	-	-

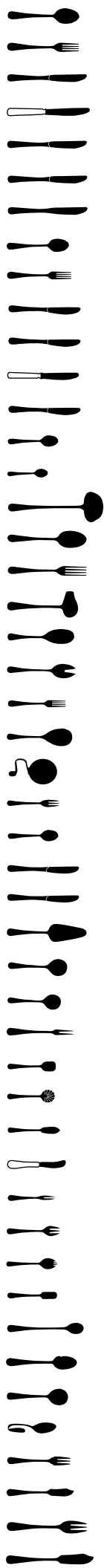

LIBERTY 1660

PINTINOX

inox 18/10
mm 3,0



LIBERTY 1660



Cod. 0011
cm 24,0
cucchiaine servire
serving spoon



Cod. 0012
cm 24,0
forchettone servire
serving fork



Cod. 0003
cm 23,0
coltello tavola
table knife



Cod. 0001
cm 21,2
cucchiaino tavola
table spoon



Cod. 0002
cm 21,0
forchetta tavola
table fork



Cod. 0029
cm 21,5
coltello pesce
fish knife



Cod. 0004
cm 18,1
cucchiaino frutta
dessert spoon



Cod. 0028
cm 19,5
forchetta pesce
fish fork



Cod. 0006
cm 20,0
coltello frutta
dessert knife



Cod. 0007
cm 15,1
cucchiaino caffè
tea/coffee spoon



Cod. 0005
cm 18,0
forchetta frutta
dessert fork



Cod. 0008
cm 11,1
cucchiaino moka
moka spoon



Cod. 0017
cm 17,0
forchetta dolce
pastry fork



Cod. 0010
cm 29,0
mestolo
soup ladle



Cod. 0020
cm 24,0
pala torta
cake server



Cod. 0013
cm 16,5
mestolo salsa
sauce ladle

Cod.	cm	Euro
0001	21,0	3,08
0002	21,0	3,08
0003	23,4	5,60
00CC	23,8	11,64
00CA	-	-
00L3	-	-
0067	23,0	5,60
0004	18,2	3,08
0005	18,2	3,08
0006	21,0	5,60
00L6	-	-
00CD	21,5	11,52
00CB	-	-
0007	14,7	1,88
0008	10,8	1,88
0010	28,8	17,68
0011	24,1	6,92
0012	24,1	6,92
0013	14,0	9,44
0014	25,0	7,14
0015	25,0	7,14
0016	-	-
0059	26,0	10,22
00AW	-	-
0017	14,6	2,10
0018	-	-
00L9	-	-
0019	-	-
0020	22,9	10,66
0052	-	-
00CR	-	-
0009	15,0	2,10
0022	14,5	1,88
0023	-	-
0025	18,0	5,56
00CS	-	-
0026	-	-
0027	14,5	2,10
00FM	-	-
0035	-	-
0036	22,0	2,54
0038	21,5	3,08
0039	18,5	3,08
00AT	-	-
0028	18,2	3,08
0029	20,3	3,08
0030	-	-
0031	-	-

PALACE 1690

PINTINOX

inox 18/10
mm 3,0



169000D3 Euro 6,04 cm 23,0 coltello verticale *standing knife*

PALACE 1690



Cod. 0059
cm 26,0
cucchiaine risotto
rice spoon



Cod. 0014
cm 25,0
cucchiaine insalata
salad spoon



Cod. 0011
cm 24,1
cucchiaine servire
servicing spoon



Cod. 0036
cm 22,0
cucchiaine bibita
long drink spoon



Cod. 0038
cm 21,5
cucchiaine gourmet
gourmet spoon



Cod. 0001
cm 21,0
cucchiaine tavola
table spoon



Cod. 0039
cm 18,5
cucchiaine brodo
soup spoon



Cod. 0004
cm 18,2
cucchiaine frutta
dessert spoon



Cod. 0007
cm 14,7
cucchiaine caffè
tea/coffee spoon



Cod. 0022
cm 14,5
paletta gelato
ice cream spoon



Cod. 0008
cm 10,8
cucchiaine moka
moka spoon



Cod. 0015
cm 25,0
forchetta insalata
salad fork



Cod. 0012
cm 24,1
forchettone servire
servicing fork



Cod. 0002
cm 21,0
forchetta tavola
table fork



Cod. 0005
cm 18,2
forchetta frutta
dessert fork



Cod. 0028
cm 18,2
forchetta pesce
fish fork



Cod. 0009
cm 15,0
forchetta carne
meat fork



Cod. 0017
cm 14,6
forchetta dolce
pastry fork



Cod. 0027
cm 14,5
forchetta ostriche
oyster fork



Cod. 0003
cm 23,4
coltello tavola
table knife



Cod. 00D3
cm 23,0
coltello verticale
standing knife



Cod. 0067
cm 23,0
coltello bistecca
steak knife



Cod. 0006
cm 21,0
coltello frutta
dessert knife



Cod. 0029
cm 20,3
coltello pesce
fish knife



Cod. 0025
cm 18,0
spalma burro
butter spreader



Cod. 0010
cm 28,8
mestolo
soup ladle



Cod. 0020
cm 22,9
pala torta
cake server



Cod. 0013
cm 14,0
mestolo salsa
sauce ladle

Cod.	cm	Euro
0001	21,0	2,62
0002	21,0	2,62
0003	22,0	3,38
00CC	-	-
00CA	-	-
00L3	22,2	2,66
0067	-	-
0004	18,2	2,62
0005	18,2	2,62
0006	20,0	3,28
00L6	-	-
00CD	-	-
00CB	-	-
0007	14,7	1,58
0008	10,8	1,58
0010	-	-
0011	-	-
0012	-	-
0013	-	-
0014	-	-
0015	-	-
0016	-	-
0059	-	-
00AW	-	-
0017	14,6	1,90
0018	-	-
00L9	-	-
0019	-	-
0020	-	-
0052	-	-
00CR	-	-
0009	-	-
0022	-	-
0023	-	-
0025	-	-
00CS	-	-
0026	-	-
0027	-	-
00FM	-	-
0035	-	-
0036	-	-
0038	-	-
0039	-	-
00AT	-	-
0028	-	-
0029	-	-
0030	-	-
0031	-	-

PALACE MARTELLATO

1680

PINTINOX

inox 18/10
mm 2,5





Cod.	cm	Euro
0001	19,5	3,08
0002	19,5	3,08
0003	21,6	5,24
00CC	-	-
00CA	-	-
00L3	-	-
0067	-	-
0004	16,6	3,08
0005	16,6	3,08
0006	19,8	5,24
00L6	-	-
00CD	-	-
00CB	-	-
0007	13,8	1,74
0008	11,6	1,74
0010	27,0	15,38
0011	22,8	6,92
0012	22,8	6,92
0013	16,7	8,14
0014	-	-
0015	22,5	8,46
0016	-	-
0059	-	-
00AW	-	-
0017	14,6	2,10
0018	-	-
00L9	-	-
0019	-	-
0020	23,2	10,66
0052	-	-
00CR	-	-
0009	-	-
0022	-	-
0023	-	-
0025	-	-
00CS	-	-
0026	-	-
0027	-	-
00FM	-	-
0035	-	-
0036	-	-
0038	-	-
0039	17,2	2,84
00AT	-	-
0028	19,2	3,52
0029	20,7	3,52
0030	-	-
0031	-	-

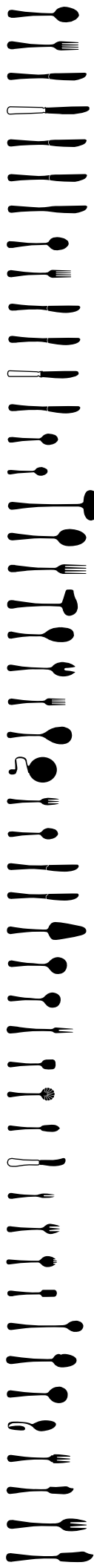

CASALI 2100

PINTINOX

inox 18/10
mm 3,0



SAVOY 1700

PINTINOX

inox 18/10

mm 3,0



Cod.	cm	Euro
0001	20,8	3,08
0002	20,9	3,08
0003	23,0	5,60
00CC	24,5	11,64
00CA	-	-
00L3	-	-
0067	-	-
0004	18,0	3,08
0005	18,1	3,08
0006	20,0	5,60
00L6	-	-
00CD	21,3	11,52
00CB	-	-
0007	14,9	1,88
0008	11,0	1,88
0010	28,0	17,68
0011	25,5	6,92
0012	25,5	6,92
0013	17,4	9,44
0014	-	-
0015	-	-
0016	-	-
0059	-	-
00AW	-	-
0017	16,1	2,10
0018	-	-
00L9	-	-
0019	-	-
0020	23,0	10,65
0052	-	-
00CR	-	-
0009	-	-
0022	-	-
0023	-	-
0025	-	-
00CS	-	-
0026	-	-
0027	-	-
00FM	-	-
0035	-	-
0036	-	-
0038	-	-
0039	-	-
00AT	-	-
0028	18,1	3,08
0029	20,0	3,08
0030	-	-
0031	-	-

Cod.	cm	Euro
0001	21,0	2,96
0002	20,8	2,96
0003	23,3	5,60
00CC	-	-
00CA	-	-
00L3	-	-
0067	23,3	5,60
0004	18,0	2,94
0005	18,0	2,94
0006	21,2	5,60
00L6	-	-
00CD	-	-
00CB	-	-
0007	15,0	2,00
0008	11,0	1,90
0010	29,0	14,14
0011	25,0	5,90
0012	25,0	5,90
0013	-	-
0014	-	-
0015	-	-
0016	-	-
0059	-	-
00AW	-	-
0017	-	-
0018	-	-
00L9	-	-
0019	-	-
0020	-	-
0052	-	-
00CR	-	-
0009	-	-
0022	-	-
0023	-	-
0025	-	-
00CS	-	-
0026	-	-
0027	-	-
00FM	-	-
0035	-	-
0036	-	-
0038	-	-
0039	-	-
00AT	-	-
0028	19,7	3,16
0029	21,8	3,16
0030	-	-
0031	-	-

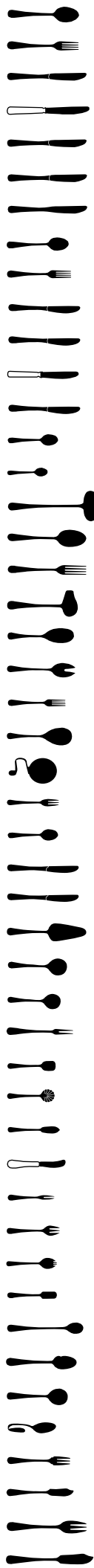

EXCELSIOR 1460

PINTINOX

inox 18/10
mm 3,0





Cod.	cm	Euro
0001	21,2	2,84
0002	21,2	2,84
0003	23,0	5,60
00CC	-	-
00CA	-	-
00L3	-	-
0067	-	-
0004	18,0	2,84
0005	18,0	2,84
0006	20,0	5,60
00L6	-	-
00CD	-	-
00CB	-	-
0007	15,0	1,74
0008	11,0	1,74
0010	28,6	15,38
0011	24,0	6,92
0012	24,0	6,92
0013	16,4	8,02
0014	-	-
0015	-	-
0016	-	-
0059	-	-
00AW	-	-
0017	16,1	2,10
0018	-	-
00L9	-	-
0019	-	-
0020	24,3	10,66
0052	-	-
00CR	-	-
0009	-	-
0022	-	-
0023	-	-
0025	-	-
00CS	-	-
0026	-	-
0027	-	-
00FM	-	-
0035	-	-
0036	-	-
0038	-	-
0039	-	-
00AT	-	-
0028	18,0	2,84
0029	19,9	2,84
0030	-	-
0031	-	-

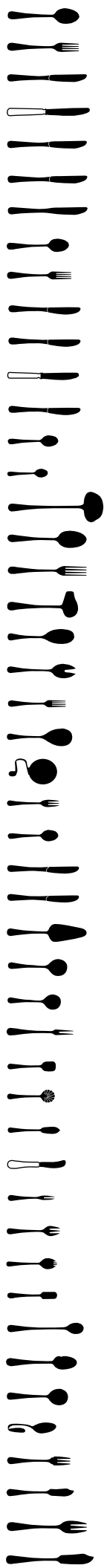

TREND 1670

PINTINOX

inox 18/10
mm 3,0



EXPO

2040

PINTINOX

inox 18/10

mm 2,5



Cod.	cm	Euro
0001	20,6	2,84
0002	20,9	2,84
0003	24,3	5,92
00CC	-	-
00CA	-	-
00L3	-	-
0067	-	-
0004	18,5	2,74
0005	18,9	2,74
0006	21,4	5,82
00L6	-	-
00CD	-	-
00CB	-	-
0007	15,0	1,64
0008	11,6	1,64
0010	-	-
0011	23,9	6,16
0012	24,0	6,16
0013	17,6	7,68
0014	-	-
0015	-	-
0016	-	-
0059	-	-
00AW	-	-
0017	15,2	1,98
0018	-	-
00L9	-	-
0019	-	-
0020	-	-
0052	-	-
00CR	-	-
0009	-	-
0022	-	-
0023	-	-
0025	-	-
00CS	-	-
0026	-	-
0027	-	-
00FM	-	-
0035	-	-
0036	-	-
0038	-	-
0039	-	-
00AT	-	-
0028	18,9	3,40
0029	19,7	3,40
0030	-	-
0031	-	-

Cod.	cm	Euro
0001	21,0	2,74
0002	21,2	2,74
0003	22,5	5,12
00CC	-	-
00CA	-	-
00L3	-	-
0067	22,5	4,44
0004	18,3	2,74
0005	18,2	2,74
0006	20,1	5,12
00L6	-	-
00CD	-	-
00CB	-	-
0007	14,8	1,64
0008	10,9	1,64
0010	26,9	16,26
0011	24,9	6,48
0012	25,1	6,48
0013	16,4	8,02
0014	-	-
0015	-	-
0016	-	-
0059	-	-
00AW	-	-
0017	16,1	1,88
0018	-	-
00L9	-	-
0019	-	-
0020	22,8	7,68
0052	-	-
00CR	-	-
0009	-	-
0022	-	-
0023	-	-
0025	-	-
00CS	-	-
0026	-	-
0027	-	-
00FM	-	-
0035	-	-
0036	22,1	2,54
0038	-	-
0039	-	-
00AT	-	-
0028	18,5	2,74
0029	20,7	2,74
0030	-	-
0031	-	-

SYNTHESIS 2030

PINTINOX

inox 18/10
mm 3,0



203000D3 Euro 5,12 cm 22,6 coltello curvo curved knife

SYNTHESIS 2030



Cod. 0011
cm 24,9
cucchiaine servire
serving spoon



Cod. 0012
cm 25,1
forchettone servire
serving fork



Cod. 00D3
cm 22,6
coltello curvo
curved knife



Cod. 0036
cm 22,1
cucchiaino bibita
long drink spoon



Cod. 0002
cm 21,2
forchetta tavola
table fork



Cod. 0003
cm 22,5
coltello tavola
table knife



Cod. 0001
cm 21,0
cucchiaino tavola
table spoon



Cod. 0028
cm 18,5
forchetta pesce
fish fork



Cod. 0067
cm 22,5
coltello bistecca
steak knife



Cod. 0004
cm 18,3
cucchiaino frutta
dessert spoon



Cod. 0005
cm 18,2
forchetta frutta
dessert fork



Cod. 0029
cm 20,7
coltello pesce
fish knife



Cod. 0007
cm 14,8
cucchiaino caffè
tea/coffee spoon



Cod. 0017
cm 16,1
forchetta dolce
pastry fork



Cod. 0006
cm 20,1
coltello frutta
dessert knife



Cod. 0008
cm 10,9
cucchiaino moka
moka spoon



Cod. 0010
cm 26,9
mestolo
soup ladle



Cod. 0020
cm 22,8
pala torta
cake server



Cod. 0013
cm 16,4
mestolo salsa
sauce ladle

Cod.	cm	Euro
0001	20,0	2,80
0002	20,0	2,80
0003	22,0	3,90
00CC	-	-
00CA	-	-
00L3	-	-
0067	-	-
0004	18,0	2,80
0005	18,0	2,80
0006	20,0	3,90
00L6	-	-
00CD	-	-
00CB	-	-
0007	14,0	2,36
0008	11,0	2,24
0010	-	-
0011	-	-
0012	-	-
0013	-	-
0014	-	-
0015	-	-
0016	-	-
0059	-	-
00AW	-	-
0017	15,4	2,38
0018	-	-
00L9	-	-
0019	-	-
0020	-	-
0052	-	-
00CR	-	-
0009	-	-
0022	-	-
0023	-	-
0025	16,9	3,30
00CS	-	-
0026	-	-
0027	-	-
00FM	-	-
0035	-	-
0036	19,0	2,70
0038	-	-
0039	19,0	2,66
00AT	-	-
0028	-	-
0029	21,0	2,76
0030	-	-
0031	-	-

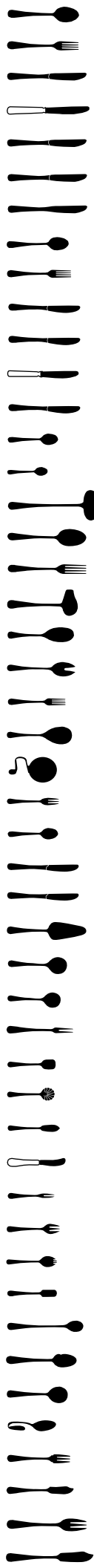

TIE 2080

PINTINOX

inox 18/0

forgiato - *forged*

Design *Daniele Ardisson*

NICKEL
FREE



SOLARIS

















































2170

PINTINOX

inox 18/10

mm 2,5



	Cod.	cm	Euro
	0001	19,7	2,74
	0002	20,0	2,74
	0003	21,5	5,12
	00CC	-	-
	00CA	-	-
	00L3	-	-
	0067	-	-
	0004	18,1	2,74
	0005	17,6	2,74
	0006	18,4	5,12
	00L6	-	-
	00CD	-	-
	00CB	-	-
	0007	13,8	1,74
	0008	12,1	1,64
	0010	27,2	14,72
	0011	22,3	6,16
	0012	22,4	6,16
	0013	17,8	8,02
	0014	-	-
	0015	22,3	7,48
	0016	-	-
	0059	-	-
	00AW	-	-
	0017	15,7	1,98
	0018	-	-
	00L9	-	-
	0019	-	-
	0020	23,6	7,68
	0052	-	-
	00CR	-	-
	0009	-	-
	0022	-	-
	0023	-	-
	0025	-	-
	00CS	-	-
	0026	-	-
	0027	-	-
	00FM	-	-
	0035	-	-
	0036	-	-
	0038	-	-
	0039	-	-
	00AT	-	-
	0028	19,1	3,40
	0029	19,4	3,40
	0030	-	-
	0031	-	-

Cod.	cm	Euro
0001	20,6	2,74
0002	20,6	2,74
0003	24,1	6,04
00CC	25,0	11,64
00CA	23,5	5,48
00L3	22,0	2,52
0067	-	-
0004	18,5	2,74
0005	18,5	2,74
0006	22,0	6,04
00L6	19,4	2,52
00CD	22,0	11,52
00CB	21,4	5,38
0007	14,6	1,74
0008	11,6	1,64
0010	27,2	14,72
0011	23,2	6,16
0012	23,6	6,16
0013	17,5	8,02
0014	-	-
0015	22,3	7,68
0016	14,7	2,10
0059	-	-
00AW	-	-
0017	15,2	1,98
0018	-	-
00L9	-	-
0019	17,8	4,70
0020	23,7	7,68
0052	-	-
00CR	-	-
0009	-	-
0022	13,7	1,74
0023	-	-
0025	-	-
00CS	-	-
0026	-	-
0027	-	-
00FM	12,5	1,98
0035	-	-
0036	-	-
0038	-	-
0039	17,9	2,64
00AT	-	-
0028	18,0	3,40
0029	19,4	3,40
0030	22,7	6,16
0031	25,1	6,16

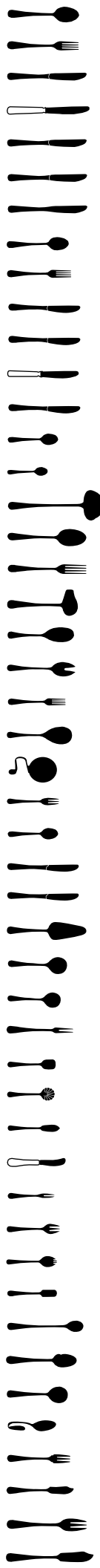

SIRIO 2260

PINTINOX

inox 18/10
mm 2,5





Cod.	cm	Euro
0001	20,6	2,74
0002	20,6	2,74
0003	24,1	6,04
00CC	25,3	11,64
00CA	-	-
00L3	-	-
0067	-	-
0004	18,5	2,74
0005	18,5	2,74
0006	22,0	6,04
00L6	-	-
00CD	22,5	11,52
00CB	-	-
0007	14,6	1,74
0008	11,8	1,64
0010	28,0	14,72
0011	23,5	6,16
0012	23,6	6,16
0013	17,5	8,02
0014	-	-
0015	-	-
0016	-	-
0059	-	-
00AW	-	-
0017	15,1	1,98
0018	-	-
00L9	-	-
0019	-	-
0020	24,0	7,68
0052	-	-
00CR	-	-
0009	-	-
0022	-	-
0023	-	-
0025	-	-
00CS	-	-
0026	-	-
0027	-	-
00FM	-	-
0035	-	-
0036	-	-
0038	-	-
0039	-	-
00AT	-	-
0028	18,0	3,40
0029	19,4	3,40
0030	-	-
0031	-	-

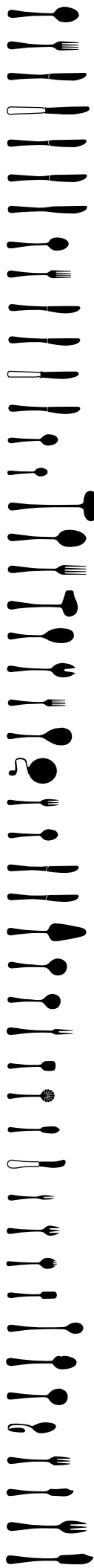

ROMA 2200

PINTINOX

inox 18/10
mm 2,5



FILET

0540

PINTINOX

inox 18/10

mm 2,5



Cod.	cm	Euro
0001	20,9	2,74
0002	20,7	2,74
0003	23,4	6,04
00CC	23,4	11,64
00CA	-	-
00L3	-	-
0067	-	-
0004	18,5	2,74
0005	18,5	2,74
0006	21,5	6,04
00L6	-	-
00CD	21,5	11,52
00CB	-	-
0007	14,6	1,74
0008	12,0	1,64
0010	27,5	14,72
0011	24,0	6,16
0012	24,1	6,16
0013	18,0	8,02
0014	-	-
0015	-	-
0016	-	-
0059	-	-
00AW	-	-
0017	15,2	1,98
0018	-	-
00L9	-	-
0019	-	-
0020	24,0	7,68
0052	-	-
00CR	-	-
0009	-	-
0022	13,6	1,74
0023	-	-
0025	-	5,88
00CS	-	-
0026	-	-
0027	-	-
00FM	-	-
0035	-	-
0036	-	-
0038	20,4	2,64
0039	-	-
00AT	-	-
0028	18,0	3,40
0029	19,6	3,40
0030	-	-
0031	-	-

Cod.	cm	Euro
0001	20,6	2,74
0002	20,9	2,74
0003	22,6	5,60
00CC	-	-
00CA	-	-
00L3	-	-
0067	22,5	5,60
0004	18,3	2,74
0005	18,5	2,74
0006	19,9	5,60
00L6	-	-
00CD	-	-
00CB	-	-
0007	15,1	1,64
0008	11,6	1,64
0010	29,3	14,72
0011	25,3	6,16
0012	23,5	6,16
0013	17,1	7,68
0014	-	-
0015	-	-
0016	-	-
0059	-	-
00AW	-	-
0017	15,3	1,98
0018	-	-
00L9	-	-
0019	-	-
0020	23,9	7,68
0052	-	-
00CR	-	-
0009	-	-
0022	-	-
0023	-	-
0025	-	-
00CS	-	-
0026	-	-
0027	-	-
00FM	-	-
0035	-	-
0036	-	-
0038	-	-
0039	-	-
00AT	-	-
0028	18,6	3,40
0029	19,6	3,40
0030	-	-
0031	-	-

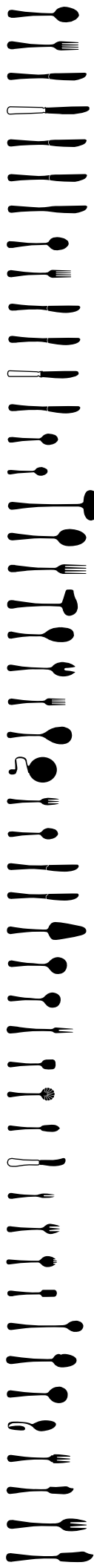

SABRINA 2090

PINTINOX

inox 18/10
mm 2,5



MAITRE 2010

PINTINOX

inox 18/10

mm 2,5



Cod.	cm	Euro
0001	20,8	2,64
0002	20,8	2,64
0003	23,0	5,60
00CC	24,5	11,64
00CA	-	-
00L3	-	-
0067	-	-
0004	17,9	2,64
0005	17,9	2,64
0006	20,0	5,60
00L6	-	-
00CD	21,3	11,52
00CB	-	-
0007	14,9	1,54
0008	11,0	1,54
0010	28,0	14,72
0011	25,3	6,16
0012	25,3	6,16
0013	16,5	8,02
0014	-	-
0015	-	-
0016	-	-
0059	-	-
00AW	-	-
0017	16,0	1,74
0018	-	-
00L9	-	-
0019	-	-
0020	22,7	7,68
0052	-	-
00CR	-	-
0009	-	-
0022	-	-
0023	-	-
0025	-	-
00CS	-	-
0026	-	-
0027	-	-
00FM	-	-
0035	-	-
0036	-	-
0038	-	-
0039	-	-
00AT	-	-
0028	17,9	2,64
0029	20,1	2,64
0030	-	-
0031	-	-

Cod.	cm	Euro
0001	19,3	2,42
0002	19,4	2,42
0003	21,1	4,70
00CC	-	-
00CA	-	-
00L3	-	-
0067	-	-
0004	17,8	2,30
0005	16,6	2,30
0006	18,0	4,70
00L6	-	-
00CD	-	-
00CB	-	-
0007	13,2	1,34
0008	11,6	1,34
0010	27,2	14,16
0011	22,2	5,92
0012	22,1	5,92
0013	16,0	8,02
0014	-	-
0015	-	-
0016	-	-
0059	-	-
00AW	-	-
0017	15,5	1,74
0018	-	-
00L9	-	-
0019	-	-
0020	23,0	7,14
0052	-	-
00CR	-	-
0009	-	-
0022	-	-
0023	-	-
0025	-	-
00CS	-	-
0026	-	-
0027	-	-
00FM	-	-
0035	-	-
0036	-	-
0038	-	-
0039	17,2	2,30
00AT	12,4	3,74
0028	17,7	2,84
0029	18,6	2,84
0030	-	-
0031	-	-

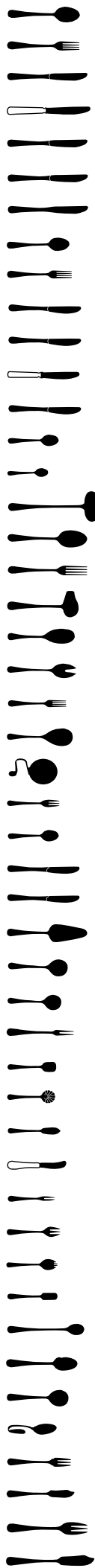

HOTEL 2020

PINTINOX

inox 18/10
mm 2,5



BRISTOL

2140

PINTINOX

inox 18/10

mm 2,5



Cod.	cm	Euro
0001	19,6	2,42
0002	19,4	2,42
0003	22,2	5,02
00CC	-	-
00CA	-	-
00L3	-	-
0067	-	-
0004	17,8	2,30
0005	17,4	2,30
0006	19,6	5,02
00L6	-	-
00CD	-	-
00CB	-	-
0007	13,4	1,44
0008	11,5	1,44
0010	26,2	14,16
0011	22,7	5,92
0012	23,2	5,92
0013	17,1	8,02
0014	-	-
0015	-	-
0016	-	-
0059	-	-
00AW	-	-
0017	14,4	1,74
0018	-	-
00L9	-	-
0019	-	-
0020	23,2	9,44
0052	-	-
00CR	-	-
0009	-	-
0022	-	-
0023	-	-
0025	-	-
00CS	-	-
0026	-	-
0027	-	-
00FM	-	-
0035	-	-
0036	-	-
0038	-	-
0039	-	-
00AT	-	-
0028	18,3	3,20
0029	19,7	3,20
0030	-	-
0031	-	-

Cod.	cm	Euro
0001	19,5	2,42
0002	19,5	2,42
0003	21,0	4,70
00CC	-	-
00CA	-	-
00L3	21,5	2,52
0067	-	-
0004	17,8	2,30
0005	17,1	2,30
0006	18,7	4,70
00L6	18,9	2,52
00CD	-	-
00CB	-	-
0007	13,3	1,34
0008	11,6	1,20
0010	28,0	14,16
0011	22,0	5,92
0012	22,3	5,92
0013	16,8	8,02
0014	-	-
0015	21,4	7,36
0016	-	-
0059	-	-
00AW	-	-
0017	15,9	1,64
0018	15,2	1,74
00L9	17,2	2,40
0019	-	-
0020	24,0	7,14
0052	-	-
00CR	-	-
0009	-	-
0022	13,1	1,44
0023	-	-
0025	-	-
00CS	-	-
0026	-	-
0027	-	-
00FM	-	-
0035	-	-
0036	22,0	2,20
0038	-	-
0039	-	-
00AT	-	-
0028	18,9	2,84
0029	22,2	2,84
0030	22,3	5,92
0031	24,5	5,92

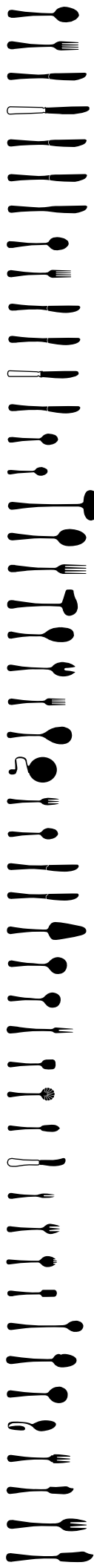

AMERICA 2240

PINTINOX

inox 18/10
mm 2,5



BRASILIA

2230

PINTINOX

inox 18/10

mm 2,5



	Cod.	cm	Euro
	0001	19,5	2,42
	0002	19,5	2,42
	0003	21,0	4,70
	00CC	-	-
	00CA	-	-
	00L3	-	-
	0067	-	-
	0004	17,8	2,30
	0005	17,1	2,30
	0006	18,7	4,70
	00L6	-	-
	00CD	-	-
	00CB	-	-
	0007	13,3	1,34
	0008	11,6	1,20
	0010	28,0	14,16
	0011	22,0	5,92
	0012	22,3	5,92
	0013	16,8	8,02
	0014	-	-
	0015	21,4	7,36
	0016	-	-
	0059	-	-
	00AW	-	-
	0017	15,9	1,64
	0018	-	-
	00L9	-	-
	0019	-	-
	0020	24,0	7,14
	0052	-	-
	00CR	-	-
	0009	-	-
	0022	13,1	1,44
	0023	-	-
	0025	-	-
	00CS	-	-
	0026	-	-
	0027	-	-
	00FM	-	-
	0035	-	-
	0036	22,0	2,20
	0038	-	-
	0039	-	-
	00AT	-	-
	0028	18,9	2,84
	0029	22,2	2,84
	0030	-	-
	0031	-	-

Cod.	cm	Euro
0001	19,6	2,20
0002	19,6	2,20
0003	21,0	4,70
00CC	-	-
00CA	-	-
00L3	-	-
0067	-	-
0004	17,8	2,10
0005	17,9	2,10
0006	19,2	4,70
00L6	-	-
00CD	-	-
00CB	-	-
0007	13,7	1,54
0008	12,3	1,44
0010	27,5	14,16
0011	22,0	5,92
0012	22,4	5,92
0013	18,0	8,02
0014	-	-
0015	21,8	7,36
0016	-	-
0059	-	-
00AW	-	-
0017	15,9	1,54
0018	-	-
00L9	-	-
0019	-	-
0020	21,7	9,44
0052	-	-
00CR	-	-
0009	-	-
0022	13,6	1,34
0023	-	-
0025	-	-
00CS	-	-
0026	-	-
0027	-	-
00FM	-	-
0035	-	-
0036	22,0	2,10
0038	-	-
0039	-	-
00AT	-	-
0028	19,8	2,98
0029	22,3	2,98
0030	-	-
0031	-	-

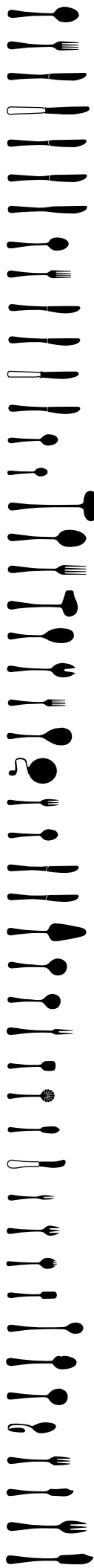

BETA 1710

PINTINOX

inox 18/10
mm 2,5



GAMMA 2150

PINTINOX

inox 18/10

mm 2,5



Cod.	cm	Euro
0001	19,6	2,20
0002	19,6	2,20
0003	21,0	4,70
00CC	-	-
00CA	-	-
00L3	21,6	2,52
0067	-	-
0004	17,8	2,10
0005	17,9	2,10
0006	19,1	4,70
00L6	19,5	2,52
00CD	-	-
00CB	-	-
0007	13,7	1,54
0008	12,3	1,44
0010	27,5	14,16
0011	22,0	5,92
0012	22,4	5,92
0013	18,0	8,02
0014	-	-
0015	21,8	7,36
0016	-	-
0059	-	-
00AW	-	-
0017	15,9	1,54
0018	-	-
00L9	-	-
0019	-	-
0020	21,7	9,44
0052	-	-
00CR	-	-
0009	-	-
0022	13,6	1,34
0023	-	-
0025	-	-
00CS	-	-
0026	-	-
0027	-	-
00FM	-	-
0035	-	-
0036	22,0	2,10
0038	-	-
0039	18,2	2,10
00AT	11,7	3,64
0028	19,8	2,98
0029	22,3	2,98
0030	-	-
0031	-	-

Cod.	cm	Euro
0001	19,7	2,30
0002	19,3	2,30
0003	21,2	5,02
00CC	-	-
00CA	-	-
00L3	-	-
0067	-	-
0004	18,6	2,20
0005	17,4	2,20
0006	19,9	5,02
00L6	-	-
00CD	-	-
00CB	-	-
0007	13,8	1,34
0008	11,8	1,34
0010	26,9	14,16
0011	21,9	6,16
0012	22,5	6,16
0013	17,6	8,02
0014	-	-
0015	-	-
0016	-	-
0059	-	-
00AW	-	-
0017	17,5	1,34
0018	-	-
00L9	-	-
0019	-	-
0020	21,6	9,32
0052	-	-
00CR	-	-
0009	-	-
0022	-	-
0023	-	-
0025	-	-
00CS	-	-
0026	-	-
0027	-	-
00FM	-	-
0035	-	-
0036	-	-
0038	-	-
0039	-	-
00AT	-	-
0028	19,1	2,98
0029	20,6	2,98
0030	-	-
0031	-	-

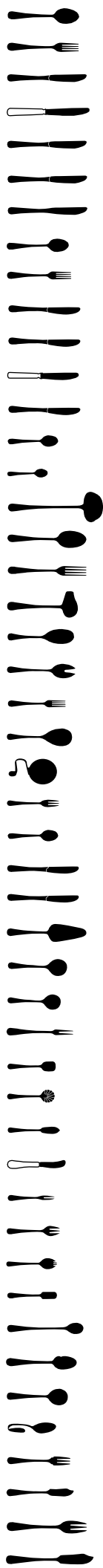

ISCHIA 2250

PINTINOX

inox 18/10
mm 2,5



TEMA

2120

PINTINOX

inox 18/10

mm 2,5



Cod.	cm	Euro
0001	19,6	2,10
0002	19,8	2,10
0003	21,2	5,02
00CC	-	-
00CA	-	-
00L3	21,4	2,52
0067	-	-
0004	17,0	2,10
0005	17,1	2,10
0006	19,1	5,02
00L6	19,5	2,52
00CD	-	-
00CB	-	-
0007	14,8	1,10
0008	11,2	1,10
0010	27,7	14,16
0011	22,3	5,50
0012	22,7	5,50
0013	17,6	8,02
0014	-	-
0015	-	-
0016	14,9	1,34
0059	-	-
00AW	-	-
0017	-	-
0018	-	-
00L9	-	-
0019	-	-
0020	23,6	8,24
0052	-	-
00CR	-	-
0009	-	-
0022	-	-
0023	-	-
0025	-	-
00CS	-	-
0026	-	-
0027	-	-
00FM	-	-
0035	-	-
0036	-	-
0038	-	-
0039	-	-
00AT	-	-
0028	17,4	2,10
0029	19,5	2,10
0030	-	-
0031	-	-

Cod.	cm	Euro
0001	21,0	2,10
0002	21,0	2,10
0003	22,6	3,08
00CC	-	-
00CA	-	-
00L3	-	-
0067	-	-
0004	-	-
0005	18,5	1,98
0006	20,3	2,98
00L6	-	-
00CD	-	-
00CB	-	-
0007	14,7	1,34
0008	11,0	1,10
0010	-	-
0011	-	-
0012	-	-
0013	-	-
0014	-	-
0015	-	-
0016	-	-
0059	-	-
00AW	-	-
0017	16,0	1,34
0018	-	-
00L9	-	-
0019	-	-
0020	-	-
0052	-	-
00CR	-	-
0009	-	-
0022	-	-
0023	-	-
0025	-	-
00CS	-	-
0026	-	-
0027	-	-
00FM	-	-
0035	-	-
0036	-	-
0038	-	-
0039	-	-
00AT	-	-
0028	-	-
0029	-	-
0030	-	-
0031	-	-

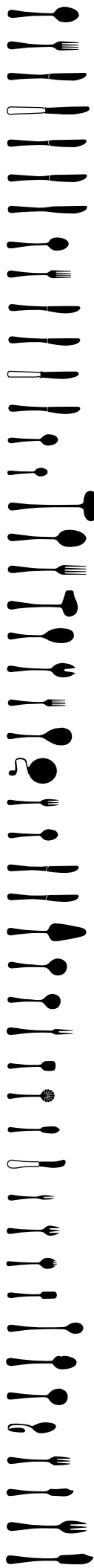

WAVE 2610

PINTINOX

inox 18/0
mm 3,0

NICKEL
FREE





Cod.	cm	Euro
0001	19,6	1,88
0002	19,6	1,88
0003	21,0	4,44
00CC	-	-
00CA	-	-
00L3	21,5	2,52
0067	-	-
0004	17,0	1,74
0005	16,9	1,74
0006	18,9	4,44
00L6	19,5	2,52
00CD	-	-
00CB	-	-
0007	13,4	1,10
0008	11,3	1,10
0010	27,2	13,28
0011	22,7	5,50
0012	22,6	5,50
0013	17,7	8,02
0014	-	-
0015	-	-
0016	-	-
0059	-	-
00AW	-	-
0017	13,5	1,34
0018	-	-
00L9	-	-
0019	-	-
0020	24,1	7,68
0052	-	-
00CR	-	-
0009	-	-
0022	-	-
0023	-	-
0025	-	-
00CS	-	-
0026	-	-
0027	-	-
00FM	-	-
0035	-	-
0036	-	-
0038	-	-
0039	-	-
00AT	-	-
0028	17,2	2,74
0029	19,6	2,74
0030	-	-
0031	-	-

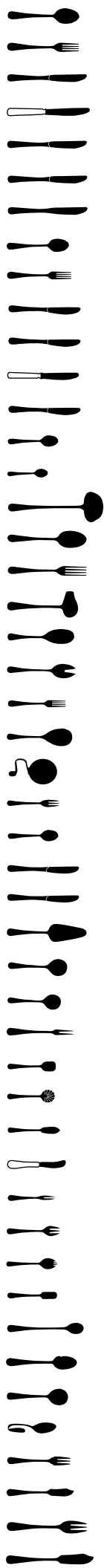

AIDA 1380

PINTINOX

inox 18/10
mm 2,0



AUSTRALIA 2

1400

PINTINOX

inox 18/10

mm 2,0



Cod.	cm	Euro
0001	19,0	1,88
0002	18,9	1,88
0003	20,4	4,44
00CC	-	-
00CA	-	-
00L3	19,5	2,52
0067	-	-
0004	-	-
0005	16,9	1,74
0006	18,4	4,44
00L6	19,5	2,52
00CD	-	-
00CB	-	-
0007	13,3	1,10
0008	10,8	1,10
0010	28,3	13,28
0011	21,6	5,16
0012	21,6	5,16
0013	-	-
0014	-	-
0015	-	-
0016	-	-
0059	-	-
00AW	-	-
0017	16,7	1,34
0018	-	-
00L9	-	-
0019	-	-
0020	23,0	8,14
0052	-	-
00CR	-	-
0009	-	-
0022	-	-
0023	-	-
0025	-	-
00CS	-	-
0026	-	-
0027	-	-
00FM	-	-
0035	-	-
0036	-	-
0038	-	-
0039	-	-
00AT	-	-
0028	-	-
0029	-	-
0030	-	-
0031	-	-

Cod.	cm	Euro
0001	21,1	1,88
0002	20,9	1,88
0003	23,0	4,44
00CC	-	-
00CA	-	-
00L3	-	-
0067	-	-
0004	-	-
0005	-	-
0006	-	-
00L6	-	-
00CD	-	-
00CB	-	-
0007	15,1	1,34
0008	11,0	1,20
0010	-	-
0011	-	-
0012	-	-
0013	-	-
0014	-	-
0015	-	-
0016	-	-
0059	-	-
00AW	-	-
0017	17,2	1,54
0018	-	-
00L9	-	-
0019	-	-
0020	-	-
0052	-	-
00CR	-	-
0009	-	-
0022	-	-
0023	-	-
0025	-	-
00CS	-	-
0026	-	-
0027	-	-
00FM	-	-
0035	-	-
0036	-	-
0038	-	-
0039	-	-
00AT	-	-
0028	-	-
0029	-	-
0030	-	-
0031	-	-

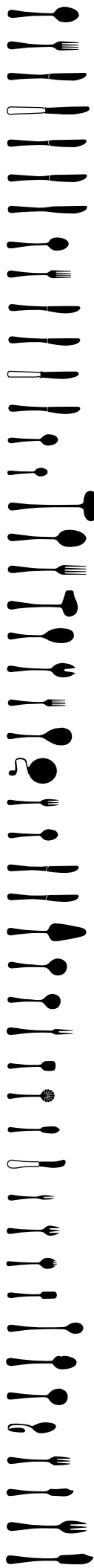

DOLPHIN

1360

PINTINOX

inox 18/10
mm 2,0



VALENCIA

















































0350

PINTINOX

inox 18/10

mm 2,0



	Cod.	cm	Euro
	0001	19,6	1,74
	0002	19,6	1,74
	0003	-	-
	00CC	-	-
	00CA	-	-
	00L3	22,0	2,52
	0067	-	-
	0004	17,8	1,74
	0005	17,7	1,74
	0006	-	-
	00L6	19,4	2,52
	00CD	-	-
	00CB	-	-
	0007	14,1	0,98
	0008	11,5	0,98
	0010	26,9	12,42
	0011	22,0	5,16
	0012	21,9	5,16
	0013	17,9	6,70
	0014	-	-
	0015	-	-
	0016	-	-
	0059	-	-
	00AW	-	-
	0017	15,1	1,10
	0018	-	-
	00L9	-	-
	0019	-	-
	0020	22,8	6,16
	0052	-	-
	00CR	-	-
	0009	-	-
	0022	-	-
	0023	-	-
	0025	-	-
	00CS	-	-
	0026	-	-
	0027	-	-
	00FM	-	-
	0035	-	-
	0036	-	-
	0038	-	-
	0039	-	-
	00AT	-	-
	0028	18,8	2,20
	0029	19,6	2,20
	0030	-	-
	0031	-	-

Cod.	cm	Euro
0001	18,8	1,74
0002	18,6	1,74
0003	20,5	4,44
00CC	-	-
00CA	-	-
00L3	22,1	2,52
0067	-	-
0004	-	-
0005	16,5	1,74
0006	18,4	4,44
00L6	-	-
00CD	-	-
00CB	-	-
0007	13,4	1,10
0008	10,8	1,10
0010	27,3	13,28
0011	21,5	5,16
0012	21,4	5,16
0013	-	-
0014	-	-
0015	-	-
0016	-	-
0059	-	-
00AW	-	-
0017	13,7	1,20
0018	-	-
00L9	-	-
0019	-	-
0020	23,5	8,14
0052	-	-
00CR	-	-
0009	-	-
0022	-	-
0023	-	-
0025	-	-
00CS	-	-
0026	-	-
0027	-	-
00FM	-	-
0035	-	-
0036	-	-
0038	-	-
0039	-	-
00AT	-	-
0028	-	-
0029	-	-
0030	-	-
0031	-	-

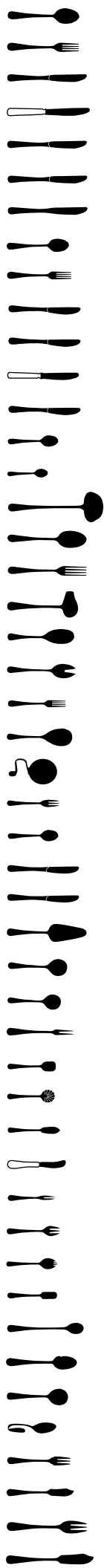

UNO
1410

PINTINOX

inox 18/10
mm 2,0





Cod.	cm	Euro
0001	19,6	1,74
0002	19,6	1,74
0003	22,2	4,00
00CC	-	-
00CA	-	-
00L3	22,0	2,52
0067	22,9	4,00
0004	17,8	1,74
0005	17,7	1,74
0006	19,5	3,90
00L6	19,4	2,52
00CD	-	-
00CB	-	-
0007	14,1	0,98
0008	11,5	0,98
0010	26,9	12,42
0011	22,0	5,16
0012	21,9	5,16
0013	17,9	6,70
0014	-	-
0015	-	-
0016	-	-
0059	-	-
00AW	-	-
0017	15,1	1,10
0018	-	-
00L9	-	-
0019	-	-
0020	22,8	6,16
0052	-	-
00CR	-	-
0009	-	-
0022	-	-
0023	-	-
0025	-	-
00CS	-	-
0026	-	-
0027	-	-
00FM	-	-
0035	-	-
0036	21,0	1,64
0038	-	-
0039	17,8	1,64
00AT	-	-
0028	18,0	2,20
0029	19,6	2,20
0030	-	-
0031	-	-

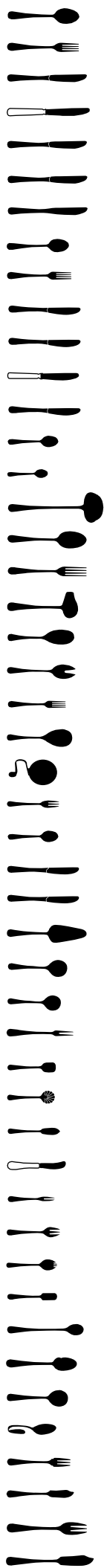

STRESA 0320

PINTINOX

inox 18/10
mm 2,0



03200051 Euro 2,74 cm 21,3 coltello pizza pizza knife

SUPERGA

















































0310

PINTINOX

inox 18/10

mm 2,0



	Cod.	cm	Euro
	0001	19,6	1,74
	0002	19,6	1,74
	0003	22,2	4,00
	00CC	-	-
	00CA	-	-
	00L3	22,0	2,52
	0067	-	-
	0004	17,8	1,74
	0005	17,7	1,74
	0006	19,5	3,90
	00L6	19,4	2,52
	00CD	-	-
	00CB	-	-
	0007	14,1	0,98
	0008	11,5	0,98
	0010	26,9	12,42
	0011	22,0	5,16
	0012	21,9	5,16
	0013	17,9	6,70
	0014	-	-
	0015	-	-
	0016	-	-
	0059	-	-
	00AW	-	-
	0017	15,1	1,10
	0018	-	-
	00L9	-	-
	0019	-	-
	0020	22,8	6,16
	0052	-	-
	00CR	-	-
	0009	-	-
	0022	-	-
	0023	-	-
	0025	-	-
	00CS	-	-
	0026	-	-
	0027	-	-
	00FM	-	-
	0035	-	-
	0036	-	-
	0038	-	-
	0039	-	-
	00AT	-	-
	0028	18,8	2,20
	0029	19,6	2,20
	0030	-	-
	0031	-	-

Cod.	cm	Euro
0001	19,6	1,74
0002	19,6	1,74
0003	-	-
00CC	-	-
00CA	-	-
00L3	22,0	2,52
0067	-	-
0004	17,8	1,74
0005	17,7	1,74
0006	-	-
00L6	19,4	2,52
00CD	-	-
00CB	-	-
0007	14,1	0,98
0008	11,5	0,98
0010	26,9	12,42
0011	22,0	5,16
0012	21,9	5,16
0013	17,9	6,70
0014	-	-
0015	-	-
0016	-	-
0059	-	-
00AW	-	-
0017	15,1	1,10
0018	-	-
00L9	-	-
0019	-	-
0020	22,8	6,16
0052	-	-
00CR	-	-
0009	-	-
0022	-	-
0023	-	-
0025	-	-
00CS	-	-
0026	-	-
0027	-	-
00FM	-	-
0035	-	-
0036	-	-
0038	-	-
0039	-	-
00AT	-	-
0028	18,0	2,20
0029	19,6	2,20
0030	-	-
0031	-	-

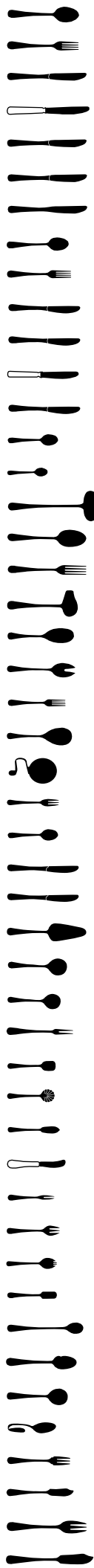

CAMBRIDGE 071M

PINTINOX

inox 18/10
mm 2,0





Cod.	cm	Euro
0001	19,7	1,44
0002	19,9	1,44
0003	-	-
00CC	-	-
00CA	-	-
00L3	21,6	2,52
0067	-	-
0004	17,1	1,44
0005	16,8	1,44
0006	-	-
00L6	19,5	2,52
00CD	-	-
00CB	-	-
0007	13,4	0,88
0008	11,4	0,88
0010	-	-
0011	-	-
0012	-	-
0013	-	-
0014	-	-
0015	-	-
0016	14,7	0,98
0059	-	-
00AW	-	-
0017	13,6	0,88
0018	-	-
00L9	-	-
0019	-	-
0020	-	-
0052	14,7	1,10
00CR	-	-
0009	-	-
0022	-	-
0023	-	-
0025	-	-
00CS	-	-
0026	-	-
0027	-	-
00FM	-	-
0035	-	-
0036	-	-
0038	-	-
0039	-	-
00AT	-	-
0028	-	-
0029	-	-
0030	-	-
0031	-	-

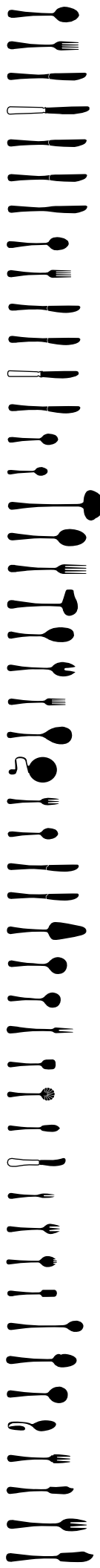

PUNTO 1220

PINTINOX

inox 18/0
mm 2,0

NICKEL
FREE



SNAKE

1140

PINTINOX

inox 18/10

mm 1,5



Cod.	cm	Euro
0001	20,8	1,34
0002	21,1	1,34
0003	23,0	2,98
00CC	-	-
00CA	-	-
00L3	22,5	1,38
0067	-	-
0004	-	-
0005	-	-
0006	-	-
00L6	-	-
00CD	-	-
00CB	-	-
0007	14,9	0,88
0008	11,1	0,78
0010	-	-
0011	-	-
0012	-	-
0013	-	-
0014	-	-
0015	-	-
0016	-	-
0059	-	-
00AW	-	-
0017	-	-
0018	-	-
00L9	-	-
0019	-	-
0020	-	-
0052	-	-
00CR	-	-
0009	-	-
0022	-	-
0023	-	-
0025	-	-
00CS	-	-
0026	-	-
0027	-	-
00FM	-	-
0035	-	-
0036	-	-
0038	-	-
0039	-	-
00AT	-	-
0028	-	-
0029	-	-
0030	-	-
0031	-	-

Cod.	cm	Euro
0001	19,6	1,34
0002	19,6	1,34
0003	-	-
00CC	-	-
00CA	-	-
00L3	22,0	2,52
0067	-	-
0004	17,8	1,34
0005	17,7	1,34
0006	-	-
00L6	19,4	2,52
00CD	-	-
00CB	-	-
0007	14,1	0,98
0008	11,5	0,88
0010	-	-
0011	-	-
0012	-	-
0013	-	-
0014	-	-
0015	-	-
0016	-	-
0059	-	-
00AW	-	-
0017	15,1	0,98
0018	-	-
00L9	-	-
0019	-	-
0020	-	-
0052	-	-
00CR	-	-
0009	-	-
0022	-	-
0023	-	-
0025	-	-
00CS	-	-
0026	-	-
0027	-	-
00FM	-	-
0035	-	-
0036	-	-
0038	-	-
0039	-	-
00AT	-	-
0028	18,0	1,74
0029	19,6	1,74
0030	-	-
0031	-	-

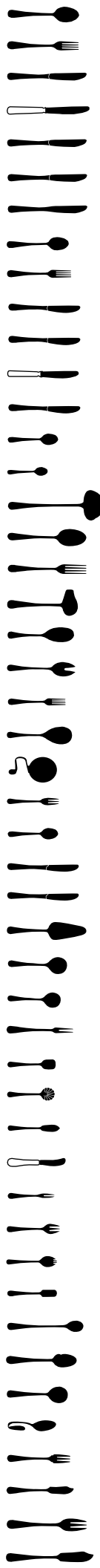

ECO BAGUETTE

0280

PINTINOX

inox 18/0

mm 2,0

NICKEL
FREE



TOURING

1250

PINTINOX

inox 18/0

mm 2,0

NICKEL
FREE



Cod.	cm	Euro
0001	21,0	1,20
0002	21,0	1,20
0003	22,0	2,98
00CC	-	-
00CA	-	-
00L3	22,0	2,74
0067	-	-
0004	-	-
0005	-	-
0006	-	-
00L6	-	-
00CD	-	-
00CB	-	-
0007	15,2	0,88
0008	11,1	0,88
0010	-	-
0011	-	-
0012	-	-
0013	-	-
0014	-	-
0015	-	-
0016	-	-
0059	-	-
00AW	-	-
0017	14,7	0,88
0018	-	-
00L9	-	-
0019	-	-
0020	-	-
0052	-	-
00CR	-	-
0009	-	-
0022	-	-
0023	-	-
0025	-	-
00CS	-	-
0026	-	-
0027	-	-
00FM	-	-
0035	-	-
0036	-	-
0038	-	-
0039	-	-
00AT	-	-
0028	-	-
0029	-	-
0030	-	-
0031	-	-

Cod.	cm	Euro
0001	20,0	0,98
0002	20,0	0,98
0003	22,0	2,98
00CC	-	-
00CA	-	-
00L3	-	-
0067	-	-
0004	-	-
0005	-	-
0006	-	-
00L6	-	-
00CD	-	-
00CB	-	-
0007	14,5	0,66
0008	11,0	0,66
0010	-	-
0011	-	-
0012	-	-
0013	-	-
0014	-	-
0015	-	-
0016	-	-
0059	-	-
00AW	-	-
0017	16,1	0,88
0018	-	-
00L9	-	-
0019	-	-
0020	-	-
0052	-	-
00CR	-	-
0009	-	-
0022	-	-
0023	-	-
0025	-	-
00CS	-	-
0026	-	-
0027	-	-
00FM	-	-
0035	-	-
0036	-	-
0038	-	-
0039	-	-
00AT	-	-
0028	-	-
0029	-	-
0030	-	-
0031	-	-

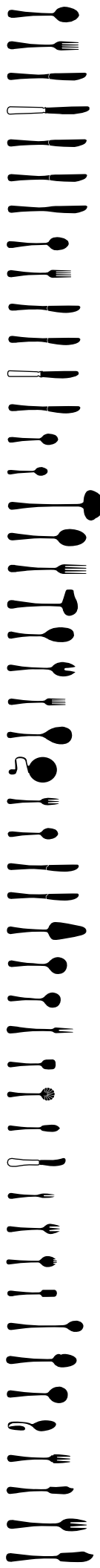

TUBE 1120

PINTINOX

inox 18/0
mm 1,5



98800860 Euro 4,80 set 100 anelli in plastica set 100 plastic rings





C O N F E Z I O N I

P a c k a g i n g











POSATE CON CRAVATTA

DISPONIBILE
SUBITO A
MAGAZZINO
AVAILABLE
IN STOCK
IMMEDIATELY

Cutlery packed with "cravatta"



Cod. 2240E... Cod. 1380E... Cod. 1250E...
America Aida Touring

	Descrizione	Description	Euro	Euro	Euro
 N° 1	001	Cucchiaino tavola Table spoon - Cuiller de table Tafellöffel - Cuchara mesa	2,54	1,98	1,34
 N° 1	002	Forchetta tavola Table fork - Fourchette de table Tafelgabel - Tenedor mesa	2,54	1,98	1,34
 N° 1	003	Coltello tavola Table knife - Couteau de table Tafelmesser - Cuchillo mesa	4,90	4,56	-
 N° 1	0L3	Coltello tavola stampato Stamped table knife - Couteau de table estampé Tafelmesser gestanzt - Cuchillo mesa estampado	2,74	2,74	2,84
 N° 1	005	Forchetta frutta Dessert fork - Fourchette dessert Dessertgabel - Tenedor postre	2,54	-	-
 N° 1	006	Coltello frutta Dessert knife - Couteau dessert Dessertmesser - Cuchillo postre	4,80	-	-
 N° 1	0L6	Coltello frutta stampato Stamped dessert knife - Couteau dessert estampé Dessertmesser gestanzt - Cuchillo postre estamp.	2,62	-	-
 N° 1	007	Cucchiaino caffè Tea/coffee spoon - Cuiller à café Kaffeelöffel - Cuchara café	1,44	1,34	1,10
 N° 1	008	Cucchiaino moka Moka spoon - Cuiller à moka Mokkalöffel - Cucharita moka	1,44	1,20	-
 N° 1	022	Paletta gelato Ice cream spoon - Cuiller à glace Eislöffel - Cuchara para helado	1,64	-	-
 N° 1	036	Cucchiaino bibita Soda spoon - Cuiller à cocktail Limolöffel - Cuchara refresco	2,42	-	-

Imballi per posate e coltelli: master da 48 "cravatte" - Packaging for cutlery - knives: outher carton including 48 "cravatte" - Emballages pour couverts - couteaux: carton de 48 "cravatte" - Verpackungen für Messer: Kartonverpackung zu 48 "Cravatte" - Embalajes para Tenedores: embalaje de 48 "cravatte"
Imballi per caffè e moka: master da 60 "cravatte" - Packaging for moka coffee maker: outher carton including 60 "cravatte" - Emballages pour café-moka: carton de 60 "cravatte" - Verpackung für Kaffee - Mokkalöffel : Kartonverpackung zu 60 "Cravatte" - Embalajes para café-moka: embalaje de 60 "cravatte"

POSATE CON CHIAVE

Cutlery packed with "chiave" pack





















Cod. 2260C...
Sirio



Cod. 2030C...
Synthesis

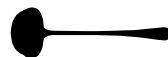



Cod.2010C...
Maitre

		Descrizione	Description	Euro	Euro	Euro
	GR 3	301	Cucchiaino tavola - Table spoon - Cuiller de table - Tafellöffel - Cuchara mesa	8,68	8,68	8,14
	GR 3	302	Forchetta tavola - Table fork - Fourchette de table - Tafel gabel - Tenedor mesa	8,68	8,68	8,14
	GR 2	203	Coltello tavola - Table knife - Couteau de table - Tafelmesser - Cuchillo mesa	12,44	10,60	11,52
	GR 2	2L3	Colt. tav. stamp. - Stamp. table knife - Cout. de table estampé - Tafelmesser gest. - Cuch. mesa estam.	-	-	-
	GR 3	304	Cucchiaino frutta - Dessert spoon - Cuiller dessert - Dessertlöffel - Cuchara postre	-	-	-
	GR 3	305	Forchetta frutta - Dessert fork - Fourchette dessert - Dessertgabel - Tenedor postre	-	-	-
	GR 2	206	Coltello frutta - Dessert knife - Couteau dessert - Dessertmesser - Cuchillo postre	-	-	-
	GR 2	2L6	Colt. frutta stamp. - Stamp. dessert knife - Cout. dessert estampé - Dessertmes. gest. - Cuch. postre estam.	-	-	-
	GR 6	607	Cucchiaino caffè - Tea/coffee spoon - Cuiller à café - Kaffeelöffel - Cuchara café	10,54	10,22	9,58
	GR 6	608	Cucchiaino moka - Moka spoon - Cuiller à moka - Mokkalöffel - Cucharita moka	10,44	-	-
	GR 6	617	Forchettina dolce 3 spine - Pastry fork - Fourchette à gateau - Kuchengabel 3 Zinken - Tenedor postre 3 púas	-	-	-
	GR 3	322	Paletta gelato - Ice cream spoon - Cuiller à glace - Eislöffel - Cuchara para helado	-	-	-
	GR 3	336	Cucchiaino bibita - Soda spoon - Cuiller à cocktail - Limolöffel - Cuchara refresco	-	-	-
	GR 3	328	Forchetta pesce - Fish fork - Fourchette à poisson - Fischgabel - Tenedor pescado	-	-	-
	GR 3	329	Coltello pesce - Fish knife - Couteau à poisson - Fischmesser - Cuchillo pescado	-	-	-
	GR 1	010	Mestolo - Soup ladle - Louche - Suppenschöpfer - Cazo sopa	-	-	-
	GR 1	011	Cucchiaino servire - Serving spoon - Cuiller de service - Servierlöffel - Cuchara servir	-	-	-
	GR 1	012	Forchettone servire - Serving fork - Fourchette de service - Serviergabel - Tenedor servir	-	-	-
	GR 1	015	Forchettone insalata - Salad fork - Fourchette à salade - Salatgabel - Tenedor ensalada	-	-	-
	GR 1	020	Pala torta - Cake server - Pelle à tarte - Tortenheber - Pala paste	-	-	-

Imballi per posate e coltelli: pezzi servire: master da 24 chiavi - Packaging for cutlery - knives - serving items outer carton: including 24 "Chiave" - Emballages pour couverts - couteaux - service: carton de 24 "Chiave" - Verpackungen für Besteck - Serviermesser: Kartonverpackung zu 24 - "Chiave" - Embalajes para cubiertos - cuchillos - servir: embalaje de 24 "Chiave"

POSATE CON CHIAVE

							
Cod. 2240C...	Cod. 1710C...	Cod.1380C...	Cod.0320C...	Cod.1220C...	Cod.2170C...	Cod. 0750C...	
America	Beta	Aida	Stresa	Punto	Solaris	Cateri	
Euro	Euro	Euro	Euro	Euro	Euro	Descr.	Euro
7,48	6,82	5,82	5,60	4,48	8,68	GR 2 251 Coltello pizza Pizza knife Couteau à pizza Pizzamesser Cuchillo pizza	7,22
7,48	6,82	5,82	5,60	4,48	8,68		
9,70	9,70	-	-	-	10,60		
5,20	-	5,56	5,20	5,20	-		
7,36	-	-	5,50	-	-	GR 2 267 Coltello bistecca Meat knife Couteau à viande Steakmeser Cuchillo chuletero	7,44
7,36	-	-	5,50	-	-		
9,70	-	-	-	-	-		
5,10	-	-	5,10	-	-		
7,92	9,32	6,82	6,48	5,82	10,56	GR 3 366 Forchetta pizza Pizza fork - Fourchette à pizza - Pizza Gabel - Tenedor pizza	5,60
7,92	9,22	-	6,28	5,72	-		
10,34	9,44	-	7,14	-	-		
4,92	4,38	-	-	-	-		
6,82	6,48	-	-	-	-	GR 3 357 Cucchiaio lungo Long spoon Cuilleur long Spaghettlöffel Cuchara larga	8,78
8,78	-	-	-	-	-		
8,78	-	-	-	-	-		
14,52	14,52	-	-	-	-		
6,28	6,28	-	-	-	-	GR 3 358 Forchetta lunga Long fork Fourchette longue Spaghettigabel Tenedor largo	8,78
6,28	6,28	-	-	-	-		
-	8,02	-	-	-	-		
7,48	9,68	-	-	-	-		

Imballo per mestoli: master da 12 chiavi - Packaging for ladles: outer carton including 12 "Chiave" - Emballage louches: carton de 12 "Chiave" - Verpackungen für Schöpflöffel: Kartonverpackung zu 12 "Chiave" - Embalajes para espumaderas: embalaje de 12 "Chiave"











POSATE CON SCATOLA 11+1

Cutlery packed with 11+1 box



Cod. 17007... Cod. 22607... Cod. 22407... Cod. 21507... Cod. 20307...

Savoy Sirio America Gamma Synthesis

	Descrizione Description	Euro	Euro	Euro	Euro	Euro
 N° 12	C01 Cucchiaino tavola - Table spoon - Cuiller de table - Tafellöffel - Cuchara mesa	39,22	36,90	32,96	30,32	36,90
 N° 12	C02 Forchetta tavola - Table fork - Fourchette de table - Tafelgabel - Tenedor mesa	39,22	36,90	32,96	30,32	36,90
 N° 12	C03 Coltello tavola - Table knife - Couteau de table - Tafelhohlheftmesser - Cuchillo mesa	69,56	76,64	58,72	58,72	65,70
 N° 12	C04 Cucchiaino frutta - Dessert spoon - Cuiller dessert - Dessertlöffel - Cuchara postre	-	36,90	30,52	29,00	-
 N° 12	C05 Forchetta frutta - Dessert fork - Fourchette dessert - Dessertgabel - Tenedor postre	-	36,90	30,52	29,00	-
 N° 12	C06 Coltello frutta - Dessert knife - Couteau dessert - Dessertmesser - Cuchillo postre	-	76,64	58,48	58,48	-
 N° 12	C07 Cucchiaino caffè - Tea/coffee spoon - Cuiller à café - Kaffeelöffel - Cuchara café	25,26	25,08	19,78	22,42	23,74
 N° 12	C08 Cucchiaino moka - Moka spoon - Cuiller à moka - Mokkalöffel - Cucharita moka	-	23,74	16,82	20,22	-
 N° 12	C17 Forchettina dolce 3 spine - Pastry fork - Fourchette à gateau - Kuchengabel 3 Zinken - Tenedor postre 3 púas	-	26,70	23,74	22,42	-
 N° 12	C28 Forchetta pesce - Fish fork - Fourchette à poisson - Fischgabel - Tenedor pescado	-	42,62	-	-	-
 N° 12	C29 Coltello pesce - Fish knife - Couteau à poisson - Fischmesser - Cuchillo pescado	-	42,62	-	-	-











POSATE CON SCATOLA 11+1 TRASP.

DISPONIBILE
SUBITO A
MAGAZZINO
AVAILABLE
IN STOCK
IMMEDIATELY

Cutlery packed with transparent 11+1 box



Cod.0450K... Cod.1700K... Cod.2260K... Cod.2240K... Cod.2150K... Cod.2030K...
Concept Savoy Sirio America Gamma Synthesis

	Descrizione Description	Euro	Euro	Euro	Euro	Euro	Euro
 N° 12	C01 Cucchiaino tavola - Table spoon - Cuiller de table - Tafellöffel - Cuchara mesa	56,34	38,76	34,58	30,86	28,56	34,58
 N° 12	C02 Forchetta tavola - Table fork - Fourchette de table - Tafelgabel - Tenedor mesa	56,34	38,76	34,58	30,86	28,56	34,58
 N° 12	C03 Coltello tavola - Table knife - Couteau de table - Tafelhohlheftmesser - Cuchillo mesa	81,76	70,46	76,16	58,72	58,72	64,66
 N° 12	C04 Cucchiaino frutta - Dessert spoon - Cuiller dessert - Dessertlöffel - Cuchara postre	-	-	-	-	-	-
 N° 12	C05 Forchetta frutta - Dessert fork - Fourchette dessert - Dessertgabel - Tenedor postre	55,78	-	33,92	30,52	28,00	-
 N° 12	C06 Coltello frutta - Dessert knife - Couteau dessert - Dessertmesser - Cuchillo postre	79,96	-	75,72	58,48	58,48	-
 N° 12	C07 Cucchiaino caffè - Tea/coffee spoon - Cuiller à café - Kaffeelöffel - Cuchara café	36,12	26,34	22,96	17,68	20,54	20,74
 N° 12	C08 Cucchiaino moka - Moka spoon - Cuiller à moka - Mokkalöffel - Cucharita moka	35,90	-	22,62	16,82	20,22	-
 N° 12	C17 Forchettina dolce 3 spine - Pastry fork - Fourchette à gateau - Kuchengabel 3 Zinken - Tenedor postre 3 púas	41,18	-	25,70	22,40	20,74	-
 N° 12	C28 Forchetta pesce - Fish fork - Fourchette à poisson - Fischgabel - Tenedor pescado	-	-	-	-	-	-
 N° 12	C29 Coltello pesce - Fish knife - Couteau à poisson - Fischmesser - Cuchillo pescado	-	-	-	-	-	-

Imballo per posateria : Master da 10 scatole - Packaging for cutlery: outer carton including 10 boxes - Emballage pour couverts : carton de 10 boîtes - Verpackung für Besteck . Kartonverpackung zu 10 Schachteln - Embalaje para cubiertos: embalaje de 10 cajas

CONFEZIONAMENTO E LIBERO SERVIZIO

Packaging

CHIAVE

....C...

Aggiungere al prezzo dello sfuso

Add to the price of the unpacked item for each package

Ajouter au prix des pièces en vrac

Dem Preis des nicht verpackten Artikels für jede Packung hinzurechnen

Adicionar al precio del artículo no acondicionado

Euro 0,58

Quantità minima di 120 Chiavi per singolo articolo.

Tutte le posate possono essere confezionate con la Chiave.

The minimum quantity is 120 Chiave units per reference. All cutlery models can be packed with Chiave.



CRAVATTA

....E...

Aggiungere al prezzo dello sfuso

Add to the price of the unpacked item for each package

Ajouter au prix des pièces en vrac

Dem Preis des nicht verpackten Artikels für jede Packung hinzurechnen

Adicionar al precio del artículo no acondicionado

Euro 0,24

Quantità minima di 120 Cravatte per singolo articolo.

Tutte le posate possono essere confezionate con la Cravatta.

The minimum quantity is 120 Cravatta units per reference. All cutlery models can be packed with Cravatta.



CARTELLE PINTINOX

Pintinox coloured hang blister

Cod.	Colour	Euro
90530016	green	2,36
90530017	lillac	
90530018	fucsia	
90530019	blue	

Quantità minima di 24 cartelle per singolo articolo.

Tutte le posate possono essere confezionate con la cartella.

The minimum quantity is 24 hang blister units per reference. All cutlery models can be packed with hang blister.



CONFEZIONAMENTO E LIBERO SERVIZIO

BOX 5+1 CASH & CARRY

....V6...

Aggiungere al prezzo dello sfuso. Minimo ordine 144 pz (24 set).

Add to the price of the unpacked item for each package. Minimum order quantity 144 pcs (24 set)

Ajouter au prix des pièces en vrac

Dem Preis des nicht verpackten Artikels für jede Packung hinzurechnen

Adicionar al precio del artículo no acondicionado

Euro 1,96



SCATOLE 11+1

....7C..

Aggiungere al prezzo dello sfuso

Add to the price of the unpacked item for each package.

Ajouter au prix des pièces en vrac

Dem Preis des nicht Verpackten Artikels für jede Packung hinzurechnen

Adicionar al precio del artículo no acondic.

Euro 3,62



Quantità minima 144 pezzi (12 set) per singolo articolo. Tutte le posate possono essere confezionate in Scatole 11+1.

The minimum quantity 144 units (12 set) per reference. All cutlery models can be packed in box 11+1.

BOX 11+1 TRASPARENTE

....KC..

Aggiungere al prezzo dello sfuso

Add to the price of the unpacked item for each package.

Ajouter au prix des pièces en vrac

Dem Preis des nicht Verpackten Artikels für jede Packung hinzurechnen

Adicionar al precio del artículo no acondicionado

Euro 3,62



Quantità minima 120 pezzi (10 set) per singolo articolo. Tutte le posate possono essere confezionate in Scatole 11+1 Trasparenti.

The minimum quantity 120 units (10 set) per reference. All cutlery models can be packed in transparent box 11+1.

CONFEZIONAMENTO E LIBERO SERVIZIO

VALVE

....9...

Aggiungere al prezzo dello sfuso

Add to the price of the unpacked item for each package.

Ajouter au prix des pièces en vrac

Dem Preis des nicht Verpackten Artikels für jede Packung hinzurechnen

Adicionar al precio del articulo no acondicionado

Euro 1,30

Quantita'minima 120 pezzi.

The minimum quantity 120 units.



ETICHETTA BAR CODE SINGOLA

....3...

Aggiungere al prezzo dello sfuso

Add to the price of the unpacked item for each package.

Ajouter au prix des pièces en vrac

Dem Preis des nicht Verpackten Artikels für jede Packung hinzurechnen

Adicionar al precio del articulo no acondicionado

Euro 0,06

Quantita'minima 1200 pezzi.

The minimum quantity 1200 units.



Imballi per posate - coltelli: master da 48 "bar code label" - Packaging for cutlery- knives: outhter carton including 48 "bar code label" - Emballages pour couverts - couteaux: carton de 48 "bar code label" - Verpackungen für Messer: Kartonverpackung zu 48 "bar code label" - Embalajes para Tenedores: embalaje de 48 "bar code label"

Imballi x caffè - moka: master da 60 "bar code label" - Packaging for moka coffee maker: outhter carton including 60 "bar code label" - Emballages pour café-moka: carton de 60 "bar code label" - Verpackung für Kaffee - Mokkalöffel : Kartonverpackung zu 60 "bar code label" - Embalajes para café-moka: embalaje de 60 "bar code label"





G L I S P E C I A L I

Special cutlery



Per alimenti
Suitable for foodstuffs
Apte au contact avec les aliments
Für Lebensmittel
Apto para alimentos



Garantito per lavastoviglie
Dishwasher safe
Inalterable dans lave-vaisselle
Spuelmaschinenfest
Apto para lavavajillas

TAVOLA - Table

CUCCHIAIO TAVOLA 18/10

Table spoon 18/10 - Cuiller de table 18/10

Tafellöffel 18/10 - Cuchara de mesa 18/10

Cod. 07400001

cm	Euro
20	4,12



FORCHETTA TAVOLA 18/10

Table fork 18/10 - Fourchette de table 18/10

Gabel mit 18/10 - Tenedor de mesa 18/10

Cod. 07400002

cm	Euro
19,5	4,12



COLTELLO BISTECCA

Steak knife - Couteau steak

Steakmesser - Cuchillo chuletero

Cod. 07400067

cm	Euro
21,1	5,90



CUCCHIAINO CAFFÈ 18/10

Tea-coffee spoon 18/10 - Cuiller a cafe 18/10

Kaffeelöffel 18/10 - Cuchara café 18/10

Cod. 07400007

cm	Euro
14,6	2,36



PASTA - *Pasta*

PALA LASAGNE 18/10

Lasagne server 18/10 - Pelle a lasagnes 18/10

Lasagneheber 18/10 - Paleta lasañas 18/10

Cod. 074000AE

cm	Euro
28	21,92



ARROSTO - *Roast meat*

FORCHETTONE ARROSTO 18/10

Carving fork 18/10 - Fourchette a roti 18/10

Vorlegegabel tenedor 18/10 - Trinchante asado 18/10

Cod. 07400068

cm	Euro
25,7	18,50



COLTELLO ARROSTO

Carving knife - Couteau a roti

Vorlegemesser - Cuchillo grande asado

Cod. 07400069

cm	Euro
28	17,34



TRINCIAPOLLO

Poultry shears - Coupe-volailles

Geflügelschere - Tijeras para aves

Cod. 074000AN

cm	Euro
25	45,88



PESCE - *Fish*

SCAVINO PER ARAGOSTA 18/10

Lobster pick 18/10 - Curette a homard 18/10

Langustengabel 18/10 - Utensilio para langosta 18/10

Cod. 074000AF

cm	Euro
18,8	6,74



PINZA PER ARAGOSTA

Lobster/seafood cracker - Pince a crustaces

Langustenzange - Pinza para langosta

Cod. 074000AG

cm	Euro
18,8	34,80

**FORMAGGIO** - *Cheese*

COLTELLO FORMAGGIO 2 PUNTE

Cheese knife - Couteau a fromage

Käsemesser 2 zinken - Cuchillo queso 2 puntas

Cod. 074000AA

cm	Euro
21,8	7,18



COLTELLO GRANA

Parmesan pick - Couteau a parmesan

Parmesankäsemesser - Cuchillo queso duro

Cod. 074000AB

cm	Euro
18,2	8,32



COLTELLO FORMAGGIO DURO
Parmesan knife - Couteau fromage
Käsemesser - Cuchillo queso
Cod. 074000AD

cm	Euro
25,9	12,00



COLTELLO FORMAGGIO TENERO
Soft cheese knife - Couteau fromage pate molle
Messer für Weichkäse - Cuchillo queso blando
Cod. 074000AL

cm	Euro
21,5	7,18



PIZZA - Pizza

COLTELLO PIZZA/CROSTACEI
Pizza / seafood knife - Couteau a pizza/crustaces
Pizza/krustentiere messer - Cuchillo pizza/marisco
Cod. 07400051

cm	Euro
21	6,16



COLTELLO TAGLIO PIZZA
Pizza serving knife - Couteau a pizza
Serviermesser für pizza - Cuchillo corte pizza
Cod. 074000AD

cm	Euro
25,9	12,00



PALA SERVIRE PIZZA 18/10
Pizza server 18/10 - Pelle de service pour pizza 18/10
Pizzaschieber 18/10 - Paleta servir pizza 18/10
Cod. 074000AI

cm	Euro
21,5	22,36



TAVERNA - Party

SCHIACCIANOCI

Nutcraker - Casse-noix

Nussknacker - Cascanueces

Cod. 074000AH

cm	Euro
18,7	31,26



COLTELLO AGRUMI

Lemon/bar knife - Couteau agrumes

Südfruchtmesser - Cuchillo citricos

Cod. 074000AM

cm	Euro
23	7,30



CAVATAPPI A CAMPANA

Cork screw - Tirebouchon

Korkenzieher - Sacacorchos a campana

Cod. 074000AR

cm	Euro
15,5	53,76



DOLCE E PANE - *Cake and Bread*

PALA DOLCE 18/10

Cake server 18/10 - Pelle a tarte 18/10

Tortenheber 18/10 - Paleta postre 18/10

Cod. 074000AP

cm	Euro
27,8	21,92



COLTELLO PANE

Bread knife - Couteau a pain

Brotmesser - Cuchillo pan

Cod. 074000AC

cm	Euro
31,8	15,18



Ogni pezzo è confezionato singolarmente.

Packaging in individual gift bag.

En sachet cadeau individuel.

In Geschenkbeutel.

Cada articulo esta presentado en bolsa de regalo.





COLTELLO MANICO VUOTO

Table knife H.H.

00CC coltello tavola m.v. lama forgiata *table knife H.H and forged blade*

00CD coltello frutta m.v. lama forgiata *dessert knife H.H and forged blade*



Cod.	Euro	
163000CC	11,64	Spaten
163000CD	11,52	



Cod.	Euro	
164000CC	11,64	Vittoriale
164000CD	11,52	



Cod.	Euro	
083000CC	11,64	Baguette
083000CD	11,52	



Cod.	Euro	
080000CC	11,64	Byron
080000CD	11,52	



Cod.	Euro	
059000CC	11,64	Palladium
059000CD	11,52	



Cod.	Euro	
081000CC	11,64	Pitagora
081000CD	11,52	



Cod.	Euro	
050000CC	11,64	Leonardo
050000CD	11,52	



Cod.	Euro	
227000CC	11,64	<i>Millenium</i>
227000CD	11,52	



Cod.	Euro	
228000CC	11,64	<i>Ritz</i>
228000CD	11,52	



Cod.	Euro	
206000CC	11,64	<i>Bernini</i>
206000CD	11,52	



Cod.	Euro	
205000CC	11,64	<i>Settecento</i>
205000CD	11,52	



Cod.	Euro	
226000CC	11,64	<i>Sirio</i>
226000CD	11,52	



Cod.	Euro	
220000CC	11,64	<i>Roma</i>
220000CD	11,52	



Cod.	Euro	
054000CC	11,64	<i>Filet</i>
054000CD	11,52	



Cod.	Euro	
201000CC	11,64	<i>Maitre</i>
201000CD	11,52	



Cod.	Euro	
170000CC	11,64	<i>Savoy</i>
170000CD	11,52	



COLTELLO BISTECCA

Steak knife

0067 coltello bistecca *steak knife*

Cod.	cm	Euro	
07600067	23	6,62	Professionale



Cod.	cm	Euro	
08000067	23	6,60	Byron



Cod.	cm	Euro	
08300067	23	6,60	Baguette



Cod.	cm	Euro	
22800067	22,8	6,44	Ritz



Cod.	cm	Euro	
22700067	23,6	6,60	Millenium



Cod.	cm	Euro	
20900067	22,5	5,60	Sabrina



COLTELLI BISTECCA

**INOX
FORGED**

Cod.	cm	Euro	
16900067	22	5,60	<i>Palace</i>

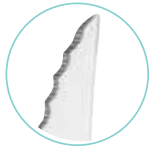

Cod.	cm	Euro	
05000067	23	6,60	<i>Leonardo</i>



Cod.	cm	Euro	
20300067	22,5	4,44	<i>Synthesis</i>

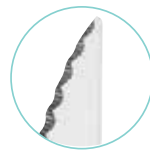

Cod.	cm	Euro	
03200067	22,9	4,00	<i>Stresa</i>



Cod.	cm	Euro	
076000EU	22,3	6,98	<i>Profess. c/manico in plastica</i>



Cod.	cm	Euro	
749000EU	23	6,80	<i>Classic con sega</i>
749000EY	23	6,80	<i>Classic liscio</i>

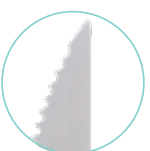

NEW

P. WOOD

Steak knife



-**Lama:** in acciaio inox 3Cr14 AISI 420, alto spessore, satinata, passante.

-**Manico:** in pakka wood con rivetti in acciaio AISI 430.

-**Blade:** in full tang 3Cr14 AISI 420, high thickness, satin finish stainless steel.

-**Handle:** in pakka wood with AISI 430 stainless steel rivets.

COLTELLO BISTECCA REGULAR

Regular steak knife - Couteau à steak Regular

Steakmesser Regular - Cuchillo chuletero normal

Cod.	descriz.	lama cm	Euro
747000EU	1 pz 1 pcs	11	3,44
747006EU	blister 6 pz blister 6 pcs	11	22,30



COLTELLO BISTECCA BIG

Big steak knife - Couteau à steak Big

Steakmesser Big - Cuchillo chuletero grande

Cod.	descriz.	lama cm	Euro
747000EJ	1 pz 1 pcs	12,3	5,98
747004EJ	blister 4 pz blister 4 pcs	12,3	27,30





SERIE CATERÌ

Cod.	cm	Euro	
07500067	23	3,64	<i>bistecca Cateri</i>

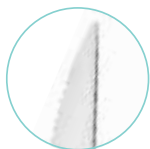

Cod.	cm	Euro	
07500051	21	3,40	<i>pizza Cateri</i>



FORCHETTA LUNGA 18/10

Long fork 18/10 - Fourchette longue 18/10
Spaghettigabel 18/10 - Tenedor largo 18/10
Cod. 07500058

cm	Euro
22	2,84



FORCHETTA PIZZA CATERÌ 18/10

Pizza fork 18/10 - Fourchette à pizza 18/10
Pizza Gabel 18/10 - Tenedor pizza 18/10
Cod. 07500066

cm	Euro
19,51	1,74



CUCCHIAIO LUNGO 18/10

Long spoon 18/10 - Cuiller long 18/10
Spaghettlöffel 18/10 - Cuchara larga 18/10
Cod. 07500057

cm	Euro
22	2,84



Accessories

Cod.	cm	Euro	
03200051	21,3	2,74	<i>pizza Stresa</i>



SCAVINO CROSTACEI 18/10

Lobster pick - Fourchette pour crustacés
 Krustentiereregabel - Utensilio para crustáceos
 Cod. 076000AF

cm	Euro
18,5	3,88



PINZA ARAGOSTA PROFESSIONAL CON MOLLA

Lobster cracker - Pince pour crustacés
 Langustenzange - Pinza para langosta
 Cod. 741000AG

cm	Euro
18,7	23,76



MULTIUSO CROSTACEI I PROFESSIONALI 18/10

Sea food pick - Fourchette pour crustacés
 Krustentiereregabe - Utensilio para crustáceos
 Cod. 076000MU

cm	Euro
23	3,84



APPOGGIO PER POSATE (acciaio inox 18/10)

Cutlery rest (18/10 stainless steel) - Repose couverts
 Messerbank - Apoyopara cubiertos
 Cod. 57010400

cm	Euro
9x3x0,9h	6,20

NEW

COLTELLI P9000

P9000 professional knives

-Coltelli professionali in Molybdenum Vanadium X50CrMoV15 Steel Alloy con manico antiscivolo in TPV.
-Gamma completa.

-Professional knives in Molybdenum Vanadium X50CrMoV15 Steel Alloy with non-slip TPV handle.
-Complete range.

COLTELLO SPELUCCHINO

Paring knife - Couteau éplucheur

Spickmesser - Cuchillo pelador

Cod. 751000EV

lama cm	Euro
9	11,50



COLTELLO AFFETTATI

Slicer knife - Couteau à charcuterie

Ausschnittmesser - Cuchillo para fiambre

Cod. 751000EV

lama cm	Euro
20	19,26



COLTELLO PER FILETTARE

Boning knife - Couteau à fileter

Filetierrechner - Cuchillo rebanador

Cod.	lama cm	Euro
751000FP	15	17,76
751000EP	20	18,98



COLTELLO DISOSSATORE

Boning knife - Couteau désosseur

Ausbeinmesser - Cuchillo deshuesador

Cod.	lama cm	Euro
751000FO	13	18,22
751000EO	15	18,66



COLTELLO CUCINA

Kitchen knife - Couteau de cuisine
 Küchenmesser - Cuchillo de cocina
 Cod. 751000EL

lama cm	Euro
15	23,46



COLTELLO CUOCO

Chef knife - Couteau chef
 Kochmesser - Cuchillo de cocinero

Cod.	lama cm	Euro
751000ET	15	21,78
751000EH	20	24,37
751000E1	25	26,20



COLTELLO PANE

Bread knife - Couteau à pain
 Brotmesser - Cuchillo de pan

Cod.	lama cm	Euro
751000EM	20	17,76
751000E5	30	22,78



COLTELLO PANE OFFSET

Offset bread knife - Couteau à pain
 Brotmesser - Cuchillo de pan
 Cod. 751000ED

lama cm	Euro
23	18,26



COLTELLO PROSCIUTTO

Ham-Slicer - Couteau à jambon
 Schinkenmesser - Cuchillo jamón

Cod.	lama cm	Euro
751000EQ	25	22,10
751000E4	30	24,38



COLTELLO SALMONE

Salmon knife - Couteau à saumon
Lachsmesser - Cuchillo para salmón
Cod. 751000ER

lama cm	Euro
30	25,74



COLTELLO SANTOKU

Santoku cook - Couteau santoku
Santokumesser - Cuchillo santoku
Cod. 751000EI

lama cm	Euro
18	24,84



COLTELLO MACELLAIO

Butcher knife - Boucher
Fleischmesser - Cuchillo carnicero

Cod.	lama cm	Euro
751000E6	20	26,20
751000E7	25	31,68



COLTELLO TRINCIANTE

Wide chef cook - Couteau chef lame large
Tranchiermesser - Cuchillo trinchante
Cod. 751000FG

lama cm	Euro
30	36,62



BORSA PORTA COLTELLI

Knives bag - Couteau de cuisine
Küchenmesser - Cuchillo de cocina
Cod. 92903004

Euro 32,90



COLTELLI PROFESSIONAL

Professional knives

MANARETTA

Cleaver - Couperet

Kochmesser - Cuchillo de carnicero

Cod. 741000EG

lama cm	(Euro pcs)	master	Euro master
18	20,80	4	83,20



COLTELLO MACELLAIO LAMA GRANDE

Butcher knife - Boucher

Fleischmesser - Cuchillo carnicero

Cod.	lama cm	(Euro pcs)	master	Euro master
741000E6	20	18,66	6	111,96
741000E7	25	22,62	6	135,72



COLTELLO CUCINA

Chef knife - Couteau de cuisine

Küchenmesser - Cuchillo de cocina

Cod.	lama cm	(Euro pcs)	master	Euro master
741000EH	20	16,98	6	101,88
741000E1	25	19,80	6	118,80



COLTELLO CUCINA ORIENTALE

Japanese cook - Couteau de cuisine

Küchenmesser - Cuchillo de cocina

Cod. 741000EI

lama cm	(Euro pcs)	master	Euro master
18	16,98	6	101,88



COLTELLO CUCINA

Chef knife - Couteau de cuisine
Küchenmesser - Cuchillo de cocina
Cod. 741000EL

lama cm	(Euro pcs)	master	Euro master
15	15,86	6	95,16



COLTELLO PANE

Bread knife - Couteau à pain
Brotmesser - Cuchillo de pan

Cod.	lama cm	(Euro pcs)	master	Euro master
741000EM	20	16,28	6	97,68
741000E5	28	19,80	6	99,00



COLTELLO AFFETTATI

Slicer knife - Couteau à charcuterie
Ausschnittmesser - Cuchillo para fiambre
Cod. 741000EN

lama cm	(Euro pcs)	master	Euro master
20	14,18	6	85,08



COLTELLO DISOSSATORE

Boning knife - Couteau désosseur
Ausbeinmesser - Cuchillo deshuesador
Cod. 741000EO

lama cm	(Euro pcs)	master	Euro master
15	14,18	6	85,08



COLTELLO PER FILETTARE

Fillet knife - Couteau à fileter
Filetiermesser - Cuchillo rebanador
Cod. 741000EP

lama cm	(Euro pcs)	master	Euro master
20	14,18	6	85,08



COLTELLI PROFESSIONAL

COLTELLO PROSCIUTTO

Ham-Slicer - Couteau à jambon
Schinkenmesser - Cuchillo jamón

Cod.	lama cm	(Euro pcs)	master	Euro master
741000EQ	26	15,18	6	91,08
741000E4	33	18,12	6	108,72



COLTELLO SALMONE

Salmon knife - Couteau à saumon
Lachsmesser - Cuchillo para salmón
Cod. 741000ER

lama cm	(Euro pcs)	master	Euro master
26	16,42	6	98,52



FORCHETTONE ARROSTO

Carving fork - Fourchette à rôti
Bratengabel - Tenedor para asado
Cod. 741000ES

lama cm	(Euro pcs)	master	Euro master
18	13,62	6	81,72



COLTELLO CUCINA

Chef knife - Couteau de cuisine
Küchenmesser - Cuchillo de cocina
Cod. 741000ET

lama cm	(Euro pcs)	master	Euro master
12	9,58	6	57,48





COLTELLO BISTECCA CON SEGA

Full serration steak knife - Couteau à viande avec scie

Steakmesser mit Sägeschliff - Cuchillo de carne con dientes

Cod. 741000EU

lama cm	(Euro pcs)	master	Euro master
12	9,58	6	57,48



COLTELLO BISTECCA SENZA SEGA

Fine edged steak knife - Couteau à viande sans scie

Steakmesser ohne Sägeschliff - Cuchillo de carne sin dientes

Cod. 741000EY

lama cm	(Euro pcs)	master	Euro master
12	9,58	6	57,48



COLTELLO SPELUCCHINO

Paring knife - Couteau éplucheur

Spickmesser - Cuchillo pelador

Cod.	lama cm	(Euro pcs)	master	Euro master
741000EV	9	9,34	6	56,04
741000E2	10	9,58	6	57,48



COLTELLO VERDURA

Peeling knife - Couteau à légumes

Gemüsemesser - Cuchillo para verdura

Cod. 741000EZ

lama cm	(Euro pcs)	master	Euro master
7,5	9,34	6	56,04



MEZZALUNA

Mincing knife - Berceuse

Gemüsemesser - Media luna

Cod. 741000EB

lama cm	(Euro pcs)	master	Euro master
26	26,56	4	106,24



PUNTA GRANA

Parmesan cheese knife - Couteau à Parmesan

Parmesankäsemesser - Cuchillo queso duro

Cod. 741000EX

lama cm	(Euro pcs)	master	Euro master
12	13,62	6	81,72



APPENDINO MAGNETICO

Aluminium magnet hanger - Crochet magnétique

Magnethalter - Colgador magnético

Cod. 741000ED

lama cm	(Euro pcs)	master	Euro master
45	18,12	6	108,72



ACCIAINO

Sharpener - Fusil aiguiseur

Messerschaerfer - Afilador

Cod. 741000E3

lama cm	(Euro pcs)	master	Euro master
24,5	17,56	6	105,36



Ogni pezzo è confezionato singolarmente.

*Packaging in individual gift bag.**En sachet cadeau individuel.**In Geschenkbeutel.**Cada articulo esta presentado en bolsa de regalo.*

NEW

SPUC

Design

C+B
LEFEBVRE



*Il mestolo versatile!
An ingenious sauce spoon!*

*~
Perfetto per nappare!
(sposta, raccogli, versa)*

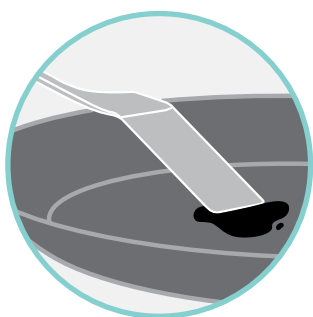

1.

SPOSTARE
STIRRING
REMUER
ZUSAMMENSCHIEBEN
MOVER

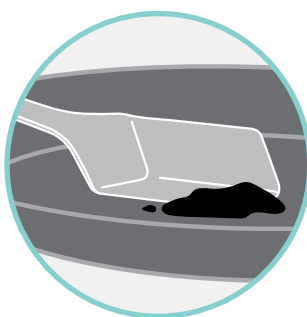

2.

RACCOGLIERE
LIFTING
RAMASSER
AUFSAMMELN
RECOGER

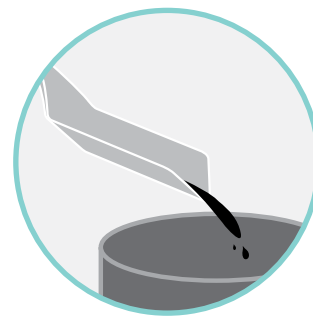

3.

VERSARE
POURING
VERSER
BERGIESSEN
VERTER

SPUC ACCIAIO INOX 18/10
18/10 stainless steel Spuc
Cod. 58730500

cm	Euro
29	18,30



SPUC ACCIAIO NYLON
Nylon Spuc
Cod. 58730501

cm	Euro
29	4,74





FORCHETTA 5 PUNTE

5 prong fork - Fourchette à 5 dents
 Serviergabel 5 zinken - Tenedor 5 púas
 Cod. 07600143

cm	(Euro pcs)	master	Euro master
30	9,04	12	108,48



CUCCHIAIONE RISOTTO

Rice spoon - Cuiller à "risotto"
 Reislöffel - Cuchara de arroz
 Cod. 07600280

cm	(Euro pcs)	master	Euro master
28	9,80	12	117,60



CUCCHIAIONE RISOTTO FORATO

Perforated rice spoon - Cuiller perforé à "risotto"
 Reislöffel gelocht - Cuchara de arroz con agujeros
 Cod. 07600260

cm	(Euro pcs)	master	Euro master
26	7,84	12	94,08



COLTELLO SERVIRE

Serving knife - Couteau à servir
 Serviermesser - Cuchillo servir
 Cod. 07600069

cm	(Euro pcs)	master	Euro master
32	12,14	12	145,68



ASTRA

**INOX
18/10**

S O L O
V E N D I T A
M A S T E R
O N L Y
M A S T E R
S E L L I N G

CUCCHIAIONE SERVIRE

Serving spoon - Cuiller à servir

Servierlöffel - Cuchara servir

Cod. 07600060

cm	(Euro pcs)	master	Euro master
26	7,84	12	94,08



PALA LASAGNE

Spatula lasagna - Pelle à lasagnes

Lasagneheber - Pala lasaña

Cod. 07600080

cm	(Euro pcs)	master	Euro master
28	9,92	12	119,04



PALA TORTA

Cake server - Pelle à torte

Tortenheber - Pala pastel

Cod. 07600081

cm	(Euro pcs)	master	Euro master
30	11,80	12	141,60



PALA UOVO

Egg lifter - Pelle à oeuf

Eierheber - Pala huevos

Cod. 07600082

cm	(Euro pcs)	master	Euro master
28	13,14	12	157,68



MESTOLO SALSA

Sauce ladle - Louche à sauce
Saucenlöffel- Cacillo salsa
Cod. 076007..

Ø cm	(Euro pcs)	master	Euro master
5	13,00	12	156,00
6	13,90	12	166,80
8	15,60	12	187,20



NEW

PALA FRITTO

Spatula - Pelle à frire
Bratwender - Espátula frito
Cod. 07600083

cm	(Euro pcs)	master	Euro master
30	12,60	12	151,12



NEW

SERVISPAGHETTI

Spaghetti server - Cuillère à spaghetti
Serviergabel für Spaghetti - Servidor de espaguetis
Cod. 07600018

cm	(Euro pcs)	master	Euro master
30	13,60	12	156,00



NEW

CUCCHIAIO GHIACCIO

Ice spoon - Cuillère à glaçons
Eisloeffel - Cuchara hielo
Cod. 07600289

cm	(Euro pcs)	master	Euro master
24	7,40	12	88,80



NEW

ASTRA

**INOX
18/10**

S O L O
V E N D I T A
M A S T E R
O N L Y
M A S T E R
S E L L I N G

FORCHETTONE

Carving fork - Fourchette à rôtir
Serviergabel - Tenedor trinchante
Cod. 07600016

cm	(Euro pcs)	master	Euro master
34	12,80	12	153,60



NEW

FORCHETTONE CURVO

Curved carving fork - Fourchette à rôtir courbée
Gebogen Serviergabel - Tenedor trinchante curvo
Cod. 07600016

cm	(Euro pcs)	master	Euro master
33	12,80	12	153,60



NEW

CUCCHIAIONE PIZZAIOLO

Tomato spoon - Cuiller à tomates
Pizza Löffel - Cuchara para pizza
Cod. 07600014

cm	(Euro pcs)	master	Euro master
28	8,24	12	98,88



FORCHETTONE 3 PUNTE MULTIUSO

3 prong fork - Fourchette à 3 dents
Mehrzweckgabel mit 3 Zinken - Tenedor 3 púas multiuso
Cod. 07600288

cm	(Euro pcs)	master	Euro master
30	8,80	12	105,60



FORCHETTONE INSALATA
Salad fork - Fourchette à salade
Salatgabel - Tenedor ensalada
Cod. 07600015

cm	(Euro pcs)	master	Euro master
28	9,80	12	117,60



FORCHETTONE SERVIRE PER VASSOIO
Serving fork - Fourchette à servir
Serviergabel - Tenedor servir
Cod. 07600088

cm	(Euro pcs)	master	Euro master
24	6,80	12	81,60



CUCCHIAIONE MULTIUSO
Serving spoon - Cuiller à servir
Servierlöffel - Cuchara servir multiuso
Cod. 07600059

cm	(Euro pcs)	master	Euro master
30	9,80	12	117,60



CUCCHIAIONE MULTIUSO FORATO
Perforated spoon - Cuiller perforé
Servierlöffel mit Lochern - Cuchara servir con agujeros
Cod. 07600259

cm	(Euro pcs)	master	Euro master
30	10,46	12	125,52



ASTRA

**INOX
18/10**

S O L O
V E N D I T A
M A S T E R
O N L Y
M A S T E R
S E L L I N G

FORCHETTA PER VASSOIO

Serving fork - Fourchette à servir

Serviergabel - Tenedor servir

Cod. 07600033

cm	(Euro pcs)	master	Euro master
20	5,12	12	61,44



CUCCHIAIO

Serving spoon - Cuiller à servir

Servierlöffel - Cuchara servir

Cod. 07600040

cm	(Euro pcs)	master	Euro master
20	5,12	12	61,44



CUCCHIAIONE SERVIRE

Serving spoon - Cuiller à servir

Servierlöffel - Cuchara servir

Cod. 07600087

cm	(Euro pcs)	master	Euro master
24	6,80	12	81,60



FORCHETTONE INSALATA

Salad fork - Fourchette à salade

Salatgabel - Tenedor ensalada

Cod. 076000CF

cm	(Euro pcs)	master	Euro master
24	8,36	12	100,32



CUCCHIAIONE MULTIUSO FORATO

Perforated spoon - Cuiller perforé

Servierlöffel mit Loechern - Cuchara servir con agujeros

Cod. 07600287

cm	(Euro pcs)	master	Euro master
24	7,68	12	92,16



CUCCHIAIO MARMELLATA/MIELE

Jam/honey spoon - Cuiller confiture/miel

Marmelade/Honig Löffel - Cuchara marmelada/miel

Cod. 076000CN

cm	(Euro pcs)	master	Euro master
19	2,60	12	31,20





PITAGORA

Posate antiscivolo - Non slip cutlery

FORCHETTA SERVIRE PER VASSOIO

Serving fork - Fourchette à servir

Serviergabel - Tenedor servir

Cod. 08100033

cm	(Euro pcs)	master	Euro master
20	5,92	12	71,04



CUCCHIAIO SERVIRE

Serving spoon - Cuiller à servir

Servierlöffel - Cuchara servir

Cod. 08100040

cm	(Euro pcs)	master	Euro master
20	5,92	12	71,04



FORCHETTONE SERVIRE PER VASSOIO

Serving fork - Fourchette à servir

Serviergabel - Tenedor servir

Cod. 08100088

cm	(Euro pcs)	master	Euro master
24	7,68	12	92,16



CUCCHIAIONE SERVIRE

Serving spoon - Cuiller à servir

Servierlöffel - Cuchara servir

Cod. 08100087

cm	(Euro pcs)	master	Euro master
24	7,68	12	92,16



CUCCHIAIONE MULTIUSO

Multipurpose spoon - Cuiller multi-usage

Mehrzweckservierlöffel - Cuchara multiuso

Cod. 08100159

cm	(Euro pcs)	master	Euro master
30	9,88	12	118,56







A C C E S S O R I T A V O L A

T a b l e a c c e s s o r i e s



Per alimenti
Suitable for foodstuffs
Apte au contact avec les aliments
Für Lebensmittel
Apto para alimentos



Garantito per lavastoviglie
Dishwasher safe
Inalterable dans lave-vaisselle
Spuelmaschinenfest
Apto para lavavajillas

SOTTOPIATTI-CLOCHE

INOX
18/10

Underplate

SOTTOPIATTO PROGETTO 1929

Underplate - Sous-assiette

Platzteller - Bajo plato

Cod. 50932831

Ø cm	Ø cm IN	Euro
31	17,8	38,82



SOTTOPIATTO BERNINI

Underplate - Sous-assiette

Platzteller - Bajo plato

Cod. 50932531

Ø cm	master	Euro
31	20	29,66



SOTTOBOTTIGLIA BERNINI

Bottle coaster - Dessous de bouteille

Flaschenteller - Posa botellas

Cod. 50913714

Ø cm	master	Euro
14	6	13,16



SOTTOBICCHIERE BERNINI

Coaster - Dessous de verre

Gläsernteller - Posa vasos

Cod. 50913611

Ø cm	master	Euro
11	6	9,22



SOTTOPIATTO PITAGORA 1929

Underplate - Sous-assiette

Platzteller - Bajo plato

Cod. 57122231

Ø cm	Ø cm IN	Euro
31	20,4	33,70



PIATTINO PORTAPANE PITAGORA 1929

Bread Coaster - Plat à pain

Brotteller - Plato de pan

Cod. 57121714

Ø cm	Euro
14	8,56



CLOCHE SEMISFERICA CON POMOLO

Semispheric cloche with knob - Cloche hémispherique avec pommeau

Speiseglocke kugelförmig mit Griff - Cloche semiesferica con pomo

Cod. 509322..

Ø cm IN	h cm	for round tray Ø cm	Euro
22	12	30	32,16
24	13	30	34,16
26	14	35	40,30
28	15	35	47,78





ACCESSORI STONE WASHED

Stone Washed accessories

COPERCHIO PER ZUPPIERA

Lid for soup bowl - Couvercle pour soupière - Deckel für Suppenterrine - Tapa para sopera
Cod. 539906..

Ø cm	Euro
18	47,54
22	54,52
24	61,08
26	69,84
28	79,68



ZUPPIERA

Soup bowl - Soupière - Suppenterrine - Sopera
Cod. 539905..

Ø cm	h cm	Lt	Euro
18	10	1,5	67,66
22	12	3	82,94
24	13	4	96,06
26	14	4,75	112,12
28	15	6	120,10

CLOCHE SEMISFERICA CON POMOLO

Semispheric cloche with knob - Cloche hémispherique avec pommeau
Speiseglocke kugelförmig mit Griff - Cloche semiesferica con pomo
Cod. 539992..

Ø cm IN	h cm	for round tray Ø cm	Euro
22	12	30	63,92
24	13	30	70,92
26	14	35	82,38
28	15	35	90,92



SALSIERA CON BASE

Sauce boat with foot - Saucière sur pied - Sauciere mit Fuß - Salsera con base
Cod. 53998014

cl	Euro
14	21,96



SOTTOPIATTO BERNINI

Underplate - Sous-assiette - Platzteller - Bajo plato

Cod. 57072731

Ø cm	Euro
31	67,66



SOTTOPIATTO/VASSOIO TONDO CHIPPENDALE

Underplate - Sous-assiette - Platzteller - Bajo plato

Cod. 509W5332

Ø cm	Euro
32	63,76



SOTTOPIATTO/VASSOIO OVALE CHIPPENDALE

Underplate - Sous-assiette - Platzteller - Bajo plato

Cod. 509W5147

cm	Euro
47x32	82,92



CESTINO QUADRATO CHIPPENDALE

Bread basket - Corbeille à pain - Brotkorb - Cesto para el pan

Cod. 509W6022

cm	Euro
22	51,86



CESTINO TONDO CHIPPENDALE

Bread basket - Corbeille à pain - Brotkorb - Cesto para el pan

Cod. 509W6225

cm	Euro
25	54,52



CESTINI

Basket

CESTINO FRUTTA PROGETTO 1929

Fruit basket - Corbeille a agrumes - Obstkorb - Cesto para naranjas

Cod. 50914425

Ø cm	h cm	Euro
25	10	61,64



CESTINO PANE PROGETTO 1929

Bread basket - Corbeille à pain - Brotkorb - Cesto para el pan

Cod. 50914225

Ø cm	h cm	Euro
25	7	57,48



PORTAGRISINI PROGETTO 1929

Bread-stick holder - Porte-gressins - "Grissini" Halter - Porta colines

Cod. 50914309

Ø cm	h cm	Euro
9,6	16	41,76



Bucket

SECCHIELLO CHAMPAGNE PITAGORA 1929

Champagne bucket - Seau à champagne

Sektkübel - Cubo de champan

Cod. 50954100

Ø cm	h cm	Euro
18	20	82,52



SECCHIELLO GHIACCIO CON MOLLA PITAGORA 1929

Ice bucket with ice tongs - Seau à glace avec pince

Eiskübel - Cubo de hielo

Cod. 50954000

Ø cm	h cm	Euro
12	12	56,30



OLIERE

Cruet

OLIERA 5 PEZZI NOUVELLE CUISINE

5 pc cruet set - Ménagère 5 pièces

Menage 5 Tlg - Vinagreras 5 piezas

Cod. 50943305

cm - h cm	Euro
17,1x14,5x20,5	75,62



OLIERA 2 PEZZI NOUVELLE CUISINE

2 pc cruet set - Ménagère 2 pièces

Menage 2 Tlg - Vinagreras 2 piezas

Cod. 50943302

cm - h cm	Euro
15x9,2x20,5	48,18



SALE/PEPE E PORTASTECCHI NOUVELLE CUISINE

Salt /pepper and toothpicks set - Set à sel/poivre et cure dents

Salz und Pfefferstreuer und Zahnstocherf - Salero con palillo

Cod. 50943510

cm - h cm	Euro
11,5x10x12	48,28



OLIERA SALE/PEPE 4 PEZZI
NOUVELLE CUISINE
4 pc cruet salt/pepper set
Ménagère avec sel et poivre
Menage 4 Tlg mit Pfeffer/Salz
Vinagreras con pimentero y salero
Cod. 50943304

cm - h cm	Euro
20x12,2x20,5	61,96

OLIERA SALE/PORTASTECCHI 4 PEZZI
NOUVELLE CUISINE
4 pc cruet salt/toothpick set
Ménagère avec saliere et cure-dents
Menage mit Salz und Zahnstocherfl
Vinagreras con salero y palillos
Cod. 509433A4

cm - h cm	Euro
20x12,2x20,5	65,04



SALE/PEPE NOUVELLE CUISINE
Salt and pepper set - Set à sel et poivre
Menage Salz und Pfefferstreuer - Salero y pimentero
Cod. 50943500

cm - h cm	Euro
11x6,8x13,5	29,52

SALE/PORTASTECCHI NOUVELLE CUISINE
Salt and toothpicks set - Set à sel et cure dents
Menage Salz und Zahnstocherfl - Salero y porta palillos
Cod. 509435A0

cm - h cm	Euro
11x6,8x13,5	28,66



FORMAGGERA CON CUCCHIAINO NOUVELLE CUISINE

Cheese bowl with cheese spoon - Fromagère avec cuillère à parmesan

Käsedose mit Käselöffel - Quesera con cuchara

Cod. 50943400

Ø cm - h cm	Euro
11,6x6,8	28,52



FORMAGGERA PROGETTO 1929

Cheese bowl - Fromagère

Käsedose - Quesera

Cod. 50944600

Ø cm - h cm	Euro
10x8	32,68



OLIERA 4 PEZZI PITAGORA 1929

4 pc cruet set - Ménagère 4 pièces

Menage 4 Tlg - Vinagreras 4 piezas

Cod. 50942600

Ø cm - h cm	Euro
17,3x24,3	87,86



FORMAGGERA PITAGORA 1929

Cheese bowl - Fromagère

Käsedose - Quesera

Cod. 50942700

Ø cm - h cm	Euro
11x12,3	37,16



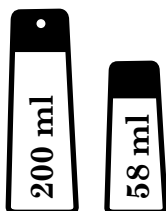

TASTE

Cruet

INOX

NEW

-Acciaio inox / vetro / ABS
-Tappo a vite con guarnizione
per olio e aceto
-Base antiscivolo

-Stainless steel / glass / ABS
-Screw top with gasket for oil
and vinegar
-Non-slip base

OLIERA 4 PEZZI

4 pc cruet set - Ménagère 4 pièces
Menage 4 Tlg - Vinagreras 4 piezas
Cod. 573A5100

cm - h cm	Euro
17x10x20	26,60



OLIERA 2 PEZZI

2 pc cruet set - Ménagère 2 pièces
Menage 2 Tlg - Vinagreras 2 piezas
Cod. 573A5000

cm - h cm	Euro
15x8x20	19,70



SET SALE/PEPE

Salt and pepper set - Set à sel et poivre
Menage Salz und Pfefferstreuer - Salero y pimentero
Cod. 573A5200

cm - h cm	Euro
10x6x13	12,30





C O T T U R A

C o o k i n g

C u i s s o n

K ü c h e n

C o c c i ò n



Gas
Gas
Gaz
Gas
Gas



Elettriche a piastra
Electricity solid hob
Plaque électrique
Elektrische Platteheizung
Electrica lisa

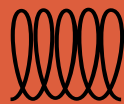

Induzione
Induction
Induction
Induktion
Induccion



Elettriche a spirale
Electricity radiant ring
Plaque électrique à spirales
Elektrische Spiralheizung
Electrica con espirales



Vetroceramica
*Electricity Radiant plate
in glass ceramic*
Vitrocéramique
Ceran
Vetroceramica



Forno
Oven
Four
Ofen
Horno



TENDER 3LAYERS

3730

Trimetallo - 3Ply

Made in Italy 



- Materiale innovativo multistrato ad alta conducibilità di calore, composto da:

- › Parete interna in Acciaio Inox 18/10 Aisi 304
- › Strato intermedio in alluminio termo-diffusore
- › Parete esterna in Acciaio Inossidabile ferritico adatto a tutte le fonti di calore, induzione compresa

- Finitura satinata interna ed esterna
- Parete e fondo a spessore costante
- Bordo rompigoccia a versare
- Maniglie e manici tubolari atermici in acciaio inox 18/10
- Rivetti di fissaggio in acciaio inox ad alta resistenza
- Indicato per cotture e conservazione prolungata degli alimenti a qualunque temperatura
- Lavabile in lavastoviglie

- 3 layers high conductivity material made of

- › 18/10 interior cooking surface
- › Aluminium heat diffuser inner core to spread heat evenly through the pan base and side walls
- › 18/0 magnetic stainless steel exterior suitable for all heating sources including induction hobs

- Satin finish inside and outside
- Base and side walls with even thickness
- Rim for clean, easy, non-drip pouring
- "stay-cool" stainless steel tube handles
- Handles with stainless steel extra strong rivets
- Dishwasher safe

TENDER 3LAYERS



CASSERUOLA FONDA 2 MANIGLIE

Deep casserole - Casserole avec 2 poignées - Fleischtopf - Cacerola honda 2 mangos
Cod. 373005..

Ø cm	h cm	Lt	Euro
20	12	3,75	54,32
24	14	6,25	69,20
28	16	9,75	81,42
32	18	14,5	114,52
36	21	21¼	142,80



CASSERUOLA MEZZA FONDA 2 MANIGLIE

Low casserole - Casserole mi-haute avec 2 poignées - Bratentopf - Cacerola baja 2 mangos
Cod. 373009..

Ø cm	h cm	Lt	Euro
20	7,5	2,25	51,98
24	9,5	4,25	62,66
28	11	6,75	74,78
32	13	10,5	97,70
36	14,5	14,75	130,26



CASSERUOLA FONDA 1 MANICO

Deep casserole - Casserole avec 1 manche - Fleischtopf - Cacerola honda 1 mangos
Cod. 373006..

Ø cm	h cm	Lt	Euro
16	10	2	44,56
20	12	3,75	59,14
24	14	6,25	77,66



TENDER 3LAYERS

NEW

CASSERUOLA BASSA CON MANICO

Low saucepan - Casserole avec 1 manche - Fleischtopf - Cacerola honda 1 mangos
Cod. 373010..

Ø cm	h cm	Lt	Euro
20	7	2¼	50,68
24	9	4¼	61,50
28	11	6¾	74,78
32	13	10½	97,70



CASSERUOLA FONDA CON UN MANICO E MANIGLIA

Saucepan - Cass. haute avec manche et poignée
Stielkasserolle mit Griff - Cazo con mango y asa
Cod. 37300728

Ø cm	h cm	Lt	Euro
28	16	9¾	88,80



CASSERUOLA CONICA

Conical casserole - Casserole conique - Konische Kasserolle, schwere Ausführung
- Cacerola conica
Cod. 373012..

Ø cm	Lt	Euro
16	1	42,40
18	1⅓	43,90
20	1¾	53,70



TENDER 3LAYERS

PADELLA SAUTÉ CON MANICO

Sauté Frying pan - Sauteuse - Stiepfanne Sauté - Sarten Sauté

Cod. 37303B..

Ø cm	h cm	Euro
20	4,3	44,30
24	5	50,68
28	5,7	60,32
32	6	71,24
36	7	93,22



PADELLA SAUTÉ ANTIADERENTE CON MANICO

Non-stick Sauté pan - Sauteuse antiadhérente - Antihaftbeschichtete Pfanne

“Sauté“ mit Stiel - Sartén salud antiadherente con mango

Cod. 37313B..

Ø cm	h cm	Euro
20	4,3	60,66
24	5	69,32
28	5,7	79,50
32	6	102,90
36	7	118,34



ROLL UP PER SERIE 3LAYERS

3Layers roll up

Cod. 99900170

Euro 176,30



COPERCHI COMPATIBILI: serie Tender pag. 188 - Serie Expo Satinato pag. 176

COMPATIBLE LIDS: Tender line pag. 188 - Expo Satinato line pag.176

CARATTERISTICHE TECNICHE

Prova di carico per pentole Catering Expo

PROVA DI CARICO PER
PENTOLA MOD. CATERING

MISURA 40
CAPACITA' CONVENZ: 30 LITRI

Condizioni di prova

- 1) forza verticale applicata alle impugnature
- 2) forza verticale applicata ad UNA impugnatura

Coefficienti di calcolo

a) efficienza delle saldature: 0.75

b) coefficiente di sicurezza rispetto
alla tensione di rottura:

$k=5$ per le tensioni semplici

$k=25$ per le tensioni composte

c) coefficiente di sicurezza rispetto
al carico di MASSIMO RIEMPIMENTO:

$k=5$ nelle condizioni 1 e 2

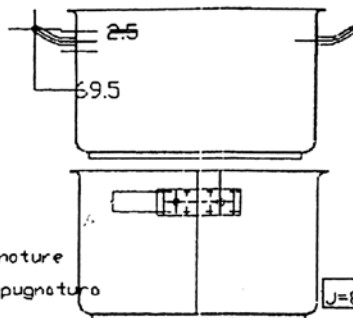

materiale: AISI 304
tensione di rottura $R_m = 500 \text{ Nmm}^{-2}$
tensione ammissibile $\sigma_{am} = 100 \text{ Nmm}^{-2}$

$K=5$ OK

sezione resistente: 8 punti di saldatura $D=2.5 \text{ mm}$
 $A = \pi \times (0.75 \times D)^2 / 4 = 2.76 \text{ mm}^2$

$$A_{tot} = 8 \times 2.76 = 22 \text{ mm}^2$$

momento d'inerzia (per $d = 0.75 \text{ D} = 1.875 \text{ mm}$)

$$J = 8 \times \pi \times (r^4 / 4 + r^2 \times l^2) = 6403 \text{ mm}^4$$

modulo di resistenza

$$W = J / l = 376.6 \text{ mm}^3$$

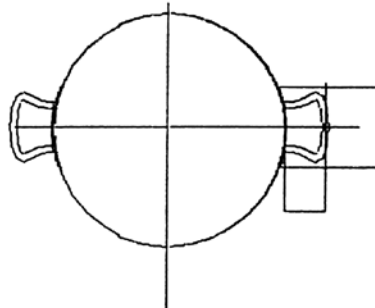

CONDIZIONE 3

CAPACITA' DEL RECIPIENTE: 29 LITRI

condizioni di riempimento: 50% acqua
50% altro
peso specifico medio: acqua = 1
altro = 2

carico totale

$$1 \times 14.5 + 2 \times 14.5 = 43.5 \text{ N}$$

In condizione 1

$$k = 4.6 \times 542 / 445 = 5.6 \text{ OK}$$

In condizione 2

$$k = 2.96 \times 1506 / 445 = 10 \text{ OK}$$

CONDIZIONE 1 $K=5$ OK

momento flettente ammissibile

$$M_{f, am} = \sigma_{am} \times W = 100 \times 376.6 = 37660 \text{ Nmm}$$

carico ammissibile corrispondente

$$V = M_{f, am} / b = 37660 / 69.5 = 542 \text{ N}$$

tensione di taglio corrispondente

$$\tau = V / A_{tot} = 542 / 22 = 24.6 \text{ Nmm}^{-2}$$

tensione composta

$$\sigma_{tot} = (\sigma_{am}^2 + 3 \tau^2)^{1/2} = 108.7 \text{ Nmm}^{-2}$$

$K=4.6$ OK

CONDIZIONE 2

momento flettente ammissibile

$$M_{f, am} = 37660 \text{ Nmm}$$

carico ammissibile

$$N = 37660 / 25 = 1506 \text{ N}$$

tensione di trazione corrispondente

$$\sigma_N = N / A_{tot} = 68.5 \text{ Nmm}^{-2}$$

tensione composta

$$\sigma_{tot} = \sigma_N + \sigma_{am} = 168.5 \text{ Nmm}^{-2}$$

$k = 500 / 168.5 = 2.96$ OK

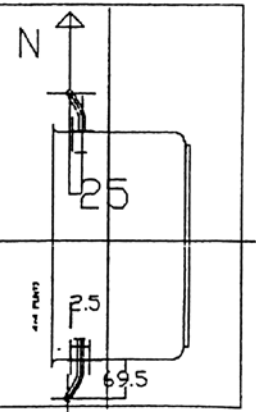

1. MANIGLIE

Sono anatomiche in tondo d'acciaio inossidabile. Pentole e casseruole sono dotate di una speciale flangia di rinforzo alle maniglie, con 10 punti di saldatura i manici dei tegami sono in tubolare ovale, leggero e robusto.

1. HANDLES

Ergonomically designed tubular stainless steel. Casseroles and pans are fitted with special handle reinforcement flanges, each welded at 10 points. Handles for pans are in robust oval tube.



2.BORDO SUPERIORE

É indurito a freddo per evitare l'ovalizzazione dei pezzi. Bordo a versare rompigoocia.

2.TOP EDGE

A cool-folding of the pouring-off edge prevents ovality of the pans'body.



3.FONDO TERMODIFFUSORE INDUZIONE

Con piastra d'alluminio di elevato spessore. Con calotta sandwich di protezione in acciaio. Fondo concavo a freddo, piano a caldo per aiutare la planarità. Adatto per cucine elettriche, a gas, vitroceramica e induzione.

3.SANDWLCH BOTTOM

Fitted with extra thick aluminium plate with steel protective cover and steel protection disk on larger pans. Bottom is specially designed to make the pan as stable as possible. Suitable for electric, gas, ceramic hobs and induction.



4.MANICI

I manici sono in tubolare per un'ottima presa e saldati con flangia di rinforzo.

4.HANDLES

Handles are made of tubular steel with a strong grip and are welded with a reinforcing flange.





EXPO SATINATO

3060

Acciaio Inox 18/10 - Stainless steel 18/10

Made in Italy 



È la classica serie professionale che racchiude tutte le caratteristiche fondamentali richieste dai migliori cuochi.

-Il fondo termodiffusore sandwich (ACCIAIO-ALLUMINIO-ACCIAIO) favorisce un'uniforme diffusione del calore.

-La calotta in materiale ferritico, può essere usata sulle piastre ad induzione.

-Le maniglie con flangia di rinforzo, resistono ad una trazione di 400 kg.

- Il bordo incrudito a freddo mantiene la rotondità dei bordi evitando l'ovalizzazione.

-Il coperchio piano con una leggera tolleranza facilita la fuoriuscita del vapore in eccesso.

-La forte satinatura mantiene nel tempo un aspetto integro ed ordinato.

-Indispensabile per coloro che utilizzano la normativa HACCP.

This is the classical professional series which has all the fundamental characteristics that the best chefs demand.

-A sandwich thermal-diffusion bottom (STEEL-ALUMINUM-STEEL) gives an even distribution of heat.

-The ferritic material cover can be used on the induction plates.

-The handles with reinforcement flange resist traction of 400 kg.

-The work hardened border keeps the borders round, avoiding out-of-round.

-The flat cover with a slight tolerance allows excess vapor to escape.

-A strong satin glazing keeps it looking in good order and integral over time.

-It is indispensable for those who abide by the HACCP norm.



PENTOLA

Pot - Marmite - Suppentopf - Olla
Cod. 306003..

Ø cm	h cm	Lt	Euro
20	20	6¼	69,96
24	24	10¾	86,30
28	25	15¼	112,88
30	30	21¼	139,46
32	32	25¾	156,46
34	34	30¾	176,88
36	36	36½	204,90
40	38	47¾	231,48
45	45	71½	322,96



CASSERUOLA FONDA 2 MANIGLIE

Deep casserole - Casserole avec 2 poignées - Fleischtopf - Cacerola honda 2 mangos
Cod. 306005..

Ø cm	h cm	Lt	Euro
20	12	3¾	55,94
24	14	6¼	71,28
28	16	9¾	83,86
30	17	12	93,02
32	18	14½	117,96
34	19	17¼	128,18
36	21	21¼	147,08
40	23	28¾	171,12
45	26	41¼	199,94
50	30	58¾	260,84



CASSERUOLA MEZZA FONDA 2 MANIGLIE

Low casserole - Casserole mi-haute avec 2 poignées - Bratentopf - Cacerola baja 2 mangos
Cod. 306009..

Ø cm	h cm	Lt	Euro
24	9,5	4¼	64,54
28	11	6¾	77,02
30	12	8½	86,96
32	13	10½	100,64
34	13,5	12¼	121,70
36	14,5	14¾	134,16
40	16	20	154,02
45	18	28½	177,64
50	20	39¼	223,52



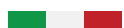

CASSERUOLA MEZZA FONDA CON MANICO

Low saucepan - Casserole avec 1 manche - Fleischtopf - Cacerola honda 1 mangos
Cod. 306010..

Ø cm	h cm	Lt	Euro
16	7,5	1¼	43,04
20	8,5	2¼	52,20
24	9,5	4¼	63,34



CASSERUOLA FONDA CON MANICO

Deep casserole - Casserole avec 1 manche - Fleischtopf - Cacerola honda 1 mangos
Cod. 306006..

Ø cm	h cm	Lt	Euro
16	10	2	45,90
20	12	3¾	60,92



CASSERUOLA FONDA CON MANICO E MANIGLIA

Saucepan - Cass. haute avec manche et poignée - Stielkasserolle mit Griff - Cazo con mango y asa
Cod. 306007..

Ø cm	h cm	Lt	Euro
24	14	6¼	79,98
28	16	9¾	92,90



CASSERUOLA CONICA PESANTE

Conical casserole - Casserole conique - Konische Kasserolle, schwere Ausführung
- Cacerola conica

Cod. 306012..

Ø cm	h cm	Lt	Euro
16	6	1	40,72
18	6,5	1 $\frac{1}{3}$	45,90
20	7	1 $\frac{3}{4}$	53,42
24	7,5	2 $\frac{3}{4}$	63,22



TEGAME 2 MANIGLIE

Frying pan 2 handles - Poêle avec 2 poignées - Pfanne mit 2 Griffen - Rustidera
2 mangos

Cod. 306023..

Ø cm	h cm	Euro
24	5	65,10
28	5,7	77,78
30	6	84,50
32	6	90,14
34	6	99,64
36	7	107,68
40	7,5	118,16
45	8	156,46
50	9	178,64



PADELLA CILINDRICA

Frying pan - Poêle avec manche - Stielpfanne mit Griff - Sarten con mango

Cod. 306026..

Ø cm	h cm	Euro
24	5	65,10
28	5,7	77,78



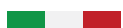

PADELLA CILINDRICA

Frying pan with counter handle - Poêle avec manche et poignée - Stielpfanne mit Griff - Sarten con mango y asa

Cod. 306026..

Ø cm	h cm	Euro
30	6	89,72
32	6	97,64
34	6	107,12
36	7	115,10
40	7,5	126,44
45	8	163,96



PADELLA ANTIADERENTE CON MANICO E MANIGLIA

Non-stick frypan with counter handle - Poêle antiadhérente avec manche et poignée - Antihftbeschichtete Pfanne mit Stiel und Griff - Sartén antiadherente con mango y asa

Cod. 306126..

Ø cm	h cm	Euro
32	6	128,54
34	6	139,92
36	7	149,94
40	8	167,06



TEGAME ANTIADERENTE 2 MANIGLIE

Non-stick Frying pan 2 handles - Poêle antiadhérente avec 2 poignées - Antihftbeschichtete Pfanne mit 2 Griffen - Rustidera antiadherente 2 mangos

Cod. 306123..

Ø cm	h cm	Euro
32	6	127,22
34	6	143,54
36	7	148,50
40	8	1627,06



COPERCHIO

Lid - Couvercle - Deckel - Tapa

Cod. 306030..

Ø cm	Euro
20	15,34
24	17,34
28	20,64
30	22,94
32	27,02
34	30,14
36	33,34
40	39,72
45	45,90
50	55,06





MASTER 3840

Acciaio Inox 18/10 - Stainless steel 18/10

Made in Italy 

NEW



-Serie made in Italy -96 pezzature coordinate

- Fusto in acciaio 18/10
- Pentole con doppia altezza e elevato litraggio (professionale /domestico)
- Triplo fondo (acciaio / alluminio / acciaio) con calotta svasata
- Maniglie professionali con flangia di rinforzo
- Bordo rinforzato antigoccia
- Elegante finitura satinata

-Made in Italy -96 items, Pintinox cookware widest range

- Stainless steel body
- Pots with double height and high capacity (professional and domestic use)
- Sandwich bottom (steel / aluminum / steel) with conical cap
- Professional handle with reinforced flange
- Rim for non-drip pouring
- Elegant satin finish



PENTOLA

Pot - Marmite - Suppentopf - Olla
Cod. 384003..

Ø cm	Lt	Euro
16	2,90	44,32
18	4,00	49,14
20	5,50	55,00
22	7,20	59,90
24	10,75	69,50
28	17,00	88,12
30	21,25	103,90
32	25,75	117,50
34	30,75	138,84
36	36,50	157,54
40	50,25	181,56
45	63,50	237,64



PENTOLA BASSA

Low pot - Marmite - Suppentopf - Olla
Cod. 3840B3..

Ø cm	Lt	Euro
16	2,50	33,40
18	3,55	36,90
20	4,95	44,70
22	6,60	49,90
24	8,45	59,40
30	15,50	93,20



CASSERUOLA FONDA 1 MANICO

Deep saucepan - Casserole haute avec manche - Stielkasserolle - Cazo con mango
Cod. 384006..

Ø cm	Lt	Euro
12	6,25	23,34
14	9,72	26,22
16	2,00	27,50
20	15,70	32,64



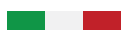

CASSERUOLA FONDA CON MANICO E MANIGLIA

Saucepan - Cass. haute avec manche et poignée

Stielkasserolle mit Griff - Cazo con mango y asa

Cod. 384007..

Ø cm	Lt	Euro
24	6,25	55,80
28	9,72	63,80
32	15,70	90,60



CASSERUOLA FONDA

Deep casserole - Casserole avec 2 poignées - Fleischtopf - Cacerola honda 2 mangos

Cod. 384005..

Ø cm	Lt	Euro
16	1,65	32,10
18	2,40	35,20
20	3,75	39,06
22	4,95	43,12
24	6,25	51,68
28	9,75	60,68
30	12,00	77,68
32	15,70	93,20
36	21,25	117,22
40	30,00	135,90
45	42,75	162,60
50	58,75	210,66



CASSERUOLA BASSA

Low casserole - Casserole mi-haute avec 2 poignées - Bratentopf - Cacerola baja 2 mangos

Cod. 384009..

Ø cm	Lt	Euro
24	3,50	46,88
28	5,75	55,44
30	7,00	69,34
32	11,00	79,84
36	13,00	105,20
40	14,50	119,00
45	15,50	141,50
50	19,00	186,60



CASSERUOLA BASSA 1 MANICO

Low saucepan - Casserole avec 1 manche - Fleischtopf - Cacerola honda 1 mangos
Cod. 384010..

Ø cm	Lt	Euro
16	1,25	31,78
20	2,25	37,90
24	3,50	45,30
28	5,75	54,46
32	11,00	74,48



TEGAME

Frying pan 2 handles - Poêle avec 2 poignées - Pfanne mit 2 Griffen - Rustidera
2 mangos
Cod. 384023..

Ø cm	Lt	Euro
24	2,60	46,88
28	3,40	55,44
30	3,85	69,34
32	4,50	79,84
34	5,50	82,50
36	6,80	105,20
40	8,20	119,00
45	12,00	141,50
50	17,00	186,60



PADELLA CON MANICO E MANIGLIA

Frying pan with counter handle - Poêle avec manche et poignée - Stielpfanne mit
Griff - Sarten con mango y asa
Cod. 384026..

Ø cm	Lt	Euro
30	3,85	65,70
32	4,50	74,50
34	5,50	86,24
36	6,80	93,44
40	8,20	103,86
45	12,00	127,90



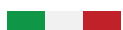

PADELLA

Frying pan - Poêle avec manche - Stielpfanne mit Griff - Sarten con mango
Cod. 384025..

Ø cm	Lt	Euro
24	2,60	39,90
28	3,40	47,90



CASSERUOLA CONICA

Conical casserole - Casserole conique - Konische Kasserolle, schwere Ausführung
- Cacerola conica
Cod. 384012..

Ø cm	Lt	Euro
16	1,00	29,90
18	1,33	34,70
20	1,75	40,00
24	2,75	45,90



BOLLILATTE

Milkpot - Pot à lait - Milchtopf - Pote
Cod. 384060..

Ø cm	Lt	Euro
12	1,40	26,54
14	2,00	30,08



COLAPASTA

Colander - Passoire - Sieb mit Griffen - Escurridera
38406224

Ø cm	Euro
24	39,50



COLABRODO

Colander - Passoire - Brühesieb - Colador
38406914

Ø cm	Euro
14	18,24



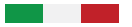

COPERCHIO

Lid - Couvercle - Deckel - Tapa

Cod. 384030..

Ø cm	Euro
16	8,80
18	9,60
20	10,60
22	10,96
24	11,30
28	13,10
30	14,10
32	16,00
34	17,40
36	18,20
40	21,80
45	25,36
50	29,36



CASSERUOLA CONICA CON BECCO

Conic casserole with pouring edge

Konische Kasserolle mit Ausguss

Sauteuse bombée avec bec verseur

Cazo cónico con boca

Cod. 384076..

Ø cm	Euro
10	26,00
12	28,90
14	32,20
16	35,60
18	39,70

WOK

Wok

38409S30

Ø cm	Euro
30	66,40



TENDER

3390

Acciaio inox 18/10 - Stainless steel 18/10

Made in Italy 



La serie Tender è studiata per rispondere alle esigenze delle comunità ed enti, è particolarmente indicata per tutte le gare d'appalto.

Le caratteristiche principali sono:

- Bordo ribordato e rinforzato.
- Corpo in acciaio inox 18/10 AISI 304.
- Maniglie tubolari anticalore.
- Fondo termo diffusore adatta anche all'utilizzo su piastra a induzione.

This new Tender series is perfect for the Communities necessities and for all the Professional kitchens use like in the Hospitals, Hotels, Restaurants and more.

Fundamentals characteristics:

- Border is reinforced and reflanged.
- Body is in AISI 304 (18/10) stainless steel.
- Tube pipe side handles in stainless steel heatsink.
- A sandwich thermal-diffusion bottom (steel/ aluminium/steel) suitable for induction.

TENDER

INOX
18/10



PENTOLA

Pot - Marmite - Suppentopf - Olla

Cod. 339003..

Ø cm	h cm	Lt	Euro
20	18	5,50	46,22
24	24	10,75	57,60
28	28	17,00	75,48
30	30	21,25	86,84
32	32	25,75	105,26
34	34	30,75	125,08
36	36	36,50	146,10
40	40	50,25	166,62
45	40	63,50	203,90



CASSERUOLA FONDA 2 MANIGLIE

Deep casserole - Casserole avec 2 poignées - Fleischtopf - Cacerola honda 2 mangos

Cod. 339005..

Ø cm	h cm	Lt	Euro
20	12	3,75	38,40
24	14,5	6,25	51,74
28	16	9,75	56,82
30	17	12,00	66,64
32	19,5	15,70	84,96
36	21,5	21,25	106,48
40	24	30,00	123,02
45	27	42,75	156,12
50	30	58,75	199,16



CASSERUOLA MEZZA FONDA 2 MANIGLIE

Low casserole - Casserole mi-haute avec 2 poignées - Bratentopf - Cacerola baja 2 mangos

Cod. 339009..

Ø cm	h cm	Lt	Euro
24	8	3,50	43,82
28	9,5	5,75	53,74
32	11	8,75	74,04
36	13	13,25	97,88
40	14,5	18,00	113,30
45	15,5	25,40	135,26
50	19	37,25	182,16



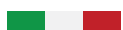

CASSERUOLA MEZZA FONDA CON MANICO

Low saucepan - Casserole avec 1 manche - Fleischtopf - Cacerola honda 1 mangos
Cod. 339010..

Ø cm	h cm	Lt	Euro
16	6,5	1,25	26,60
20	7,5	2,25	33,10
24	8	3,50	42,38
28	9,5	5,75	52,24
32	11	8,75	71,96



CASSERUOLA FONDA CON MANICO

Deep saucepan - Casserole haute avec manche - Stielkasserolle - Cazo con mango
Cod. 339006..

Ø cm	h cm	Lt	Euro
16	9,5	2,00	28,80
20	12	3,75	38,18



CASSERUOLA FONDA CON MANICO E MANIGLIA

Saucepan - Cass. haute avec manche et poignée - Stielkasserolle mit Griff - Cazo con mango y asa
Cod. 339007..

Ø cm	h cm	Lt	Euro
24	14,5	6,25	52,96
28	16	9,75	58,26
32	19,5	15,7	87,52



CASSERUOLA CONICA

Conical casserole - Casserole conique - Konische Kasserolle, schwere Ausführung - Cacerola conica
Cod. 339012..

Ø cm	h cm	Lt	Euro
16	6	1,00	24,62
18	6	1,33	27,58
20	6,5	1,75	31,34
24	7,5	2,75	34,44



PADELLA CILINDRICA

Frying pan - Poêle avec manche - Stielpfanne mit Griff - Sarten con mango
Cod. 339025..

Ø cm	h cm	Euro
24	5	39,16
28	5,5	48,56



TENDER

INOX
18/10



PADELLA CILINDRICA CON MANICO E MANIGLIA

Frying pan with counter handle - Poêle avec manche et poignée - Stielpfanne mit Griff - Sarten con mango y asa

Cod. 339026..

Ø cm	h cm	Euro
32	6	70,28
36	6	87,82
40	6	100,10
45	8	123,58



TEGAME 2 MANIGLIE

Frying pan 2 handles - Poêle avec 2 poignées - Pfanne mit 2 Griffen - Rustidera 2 mangos

Cod. 339023..

Ø cm	h cm	Euro
24	5	51,96
28	5,7	62,68
32	6	69,86
36	6	86,16
40	6	93,56
45	8	125,34
50	8	141,56



COPERCHIO INOX 18/0

Lid - Couvercle - Deckel - Tapa

Cod. 339030..

Ø cm	Euro
20	10,28
24	11,04
28	12,68
30	13,58
32	15,24
34	16,34
36	17,20
40	19,76
45	23,18
50	26,60



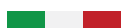

PADELLA SAUTÉ CON MANICO RIVETTATO

Sauté Frying pan - Sauteuse - Stielpfanne Sauté - Sarten Sauté

Cod. 33903B..

Ø cm	h cm	Euro
20	4,3	45,50
24	5	52,20
28	5,7	62,12
30	6	65,88
32	6	75,22
36	7	84,76



PADELLA SAUTÉ ANTIADERENTE CON MANICO

Non-stick Sauté pan - Sauteuse antiadhérente - Antihaftbeschichtete Pfanne
"Sauté" mit Stiel - Sartén salud antiadherente con mango

Cod. 33913B..

Ø cm	h cm	Euro
20	4,3	62,48
24	5	71,40
28	5,7	81,88
30	6	90,02
32	6	105,98
36	7	121,90



ROLL UP PER SERIE TENDER

Tender roll up

Cod. 99900171

Euro 172,00



TENDER SPEEDY-PASTA

INOX
18/10



CUOCIPASTA COMPLETO

4 SETTORI

Composto da:

1 pentola, 1 coperchio,

1 settore lungo,

3 settori corti

Pasta pot :

1 pot, 1 lid,

1 long section colander

3 short section colanders

Cuiseur de pâtes:

1 marmite, 1 couvercle,

1 Secteur cuit-pâtes long,

3 Secteur cuit-pâtes court

Nudelkocher:

1 Suppentopf, 1 Deckel,

1 Nudelsiebeinsatz lang,

3 Nudelsiebeinsatz kurz

Cucece-pasta:

1 Olla, 1 Tapa,

1 Sector colador alto,

3 Sector colador bajo

Cod. 3390Q404



cm ingombro	h cm	Euro
70x38	29	412,28

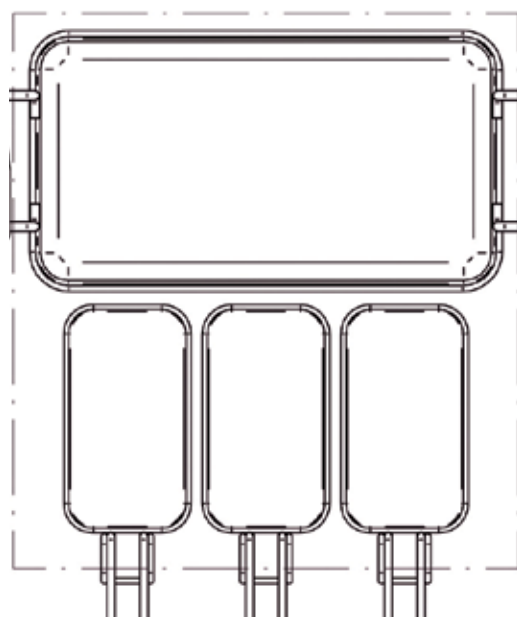

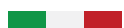

TENDER SPEEDY-PASTA

CUOCIPASTA COMPLETO

6 SETTORI

Composto da: 1 pentola, 1 coperchio, 6 settori corti

Pasta pot: 1 pot, 1 lid, 6 short section colanders

Cuiseur de pâtes: 1 marmite, 1 couvercle, 6 Secteur cuit-pâtes court

Nudelkocher: 1 Suppentopf, 1 Deckel, 6 Nudelsiebeinsatz kurz

Cuece-pasta: 1 Olla, 1 Tapa, 6 Sector colador bajo

Cod. 3390Q406

cm	h cm	Euro
70x38	29	458,20

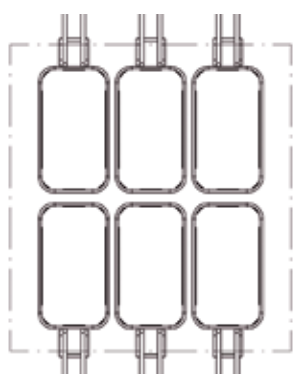

CUOCIPASTA COMPLETO

2 SETTORI

Composto da: 1 pentola, 1 coperchio, 2 settori lunghi

Pasta pot: 1 pot, 1 lid, 2 long section colanders

Cuiseur de pâtes: 1 marmite, 1 couvercle, 2 Secteur cuit-pâtes long,

Nudelkocher: 1 Suppentopf, 1 Deckel, 2 Nudelsiebeinsatz lang,

Cuece-pasta: 1 Olla, 1 Tapa, 2 Sector colador alto

Cod. 3390Q402

cm	h cm	Euro
70x38	29	366,40

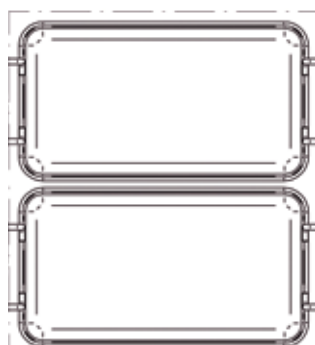

TENDER SPEEDY-PASTA

INOX
18/10



PENTOLA QUADRATA

Pot - Marmite - Suppentopf - Olla
Cod. 3390Q334

cm	h cm	Ø cm fondo	Lt	Euro
38,3x35,4	23,7	24,5	22	126,34



COPERCHIO CON SPACCO

Lid - Couvercle - Deckel - Tapa
Cod. 3390QS34

cm	h cm	Euro
35,5x32,5	9,4	65,50



SETTORE GRANDE

Long section colander - Secteur cuit-pates long
Nudelsiebeinsatz lang - Sector colador alto
Cod. 3390Q9A1

cm	h cm	Lt	n. persone <i>n. people</i>	Euro
30x14	18	6,6	6	88,46



SET 3 SETTORI PICCOLI

Short section colander - Secteur cuit-pates court
Nudelsiebeinsatz kurz - Sector colador bajo
Cod. 3390Q9A3

cm	h cm	Lt	n. persone <i>n. people</i>	Euro
14x10,5	18	2,3	1-2	140,14





TENDER ALU 3500

Alluminio - Aluminum

Made in Italy 



- Serie professionale completa per il settore HORECA.
- Tutti gli articoli sono prodotti con alluminio puro al 99,5% idoneo al contatto alimentare.
- I manici e le maniglie sono in tubolare d'acciaio inox 18/10 atermico e applicati con rivetti.
- Nickel Free.
- Ottimo per: cottura al salto, cotture lente e a fuoco moderato, cottura a parete.
- La forma di pentole e casseruole le rende impilabili.
- Per conservare il colore dell'alluminio è consigliato non lavare in lavastoviglie.

- Complete professional series for HORECA.*
- All the items are made in 99,5% pure Aluminium suitable for contact with food.*
- Riveted 18/10 (AISI 304) tubular stainless steel 18/10 (AISI 304) Handles and knobs.*
- Nickel Free.*
- Suitable for: Cuisson a sauter, Slow cooking, Browning.*
- Stockable pots and casseroles.*
- To preserve the color of aluminum is recommended do not wash in the dishwasher.*

TENDER ALU

ALLUMINIO
ALUMINUM



PENTOLA

Pot - Marmite - Suppentopf - Olla

Cod. 350003..

Ø cm	h cm	lt	Euro
20	19	4,8	36,88
24	22	8,4	40,16
28	26	13,8	48,06
30	28	17,2	52,32
32	30	21,2	54,08
36	33	29,9	70,62
40	37	41,9	81,02
45	40	58,1	120,64
50	45	81,4	137,28
60	56	147,9	197,50



CASSERUOLA FONDA

Deep casserole - Casserole avec 2 poignées - Fleischtopf - Cacerola honda 2 mangos

Cod. 350005..

Ø cm	h cm	lt	Euro
20	11	3,0	29,02
24	14	5,6	33,08
28	16	8,8	36,30
30	17	10,8	45,66
32	18	13,1	48,78
36	18	18,7	52,20
40	20	25,6	56,68
45	25	37,1	88,30
50	28	51,7	111,18
60	35	94,0	126,78



CASSERUOLA BASSA

Low casserole - Casserole mi-haute avec 2 poignées - Bratentopf - Cacerola baja 2 mangos

Cod. 350009..

Ø cm	h cm	lt	Euro
20	7	2,0	25,90
24	8	3,3	30,06
28	9	5,2	35,88
32	10	7,5	43,88
36	12	11,5	49,08
40	13	15,5	54,74
45	15	22,8	75,50
50	17	32,0	85,60
60	20	54,7	100,56



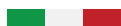

CASSERUOLA FONDA 1 MANICO

Deep saucepan - Casserole haute avec manche - Stielkasserolle - Cazo con mango
Cod. 350006..

Ø cm	h cm	lt	Euro
16	8	1,3	20,28
20	11	3,0	23,20
24	14	5,6	26,94
28	16	8,8	31,52
30	17	10,8	39,10
32	18	13,1	43,88



CASSERUOLA BASSA 1 MANICO

Low saucepan - Casserole avec 1 manche - Fleischtopf - Cacerola honda 1 mangos
Cod. 350010..

Ø cm	h cm	lt	Euro
16	6	1,1	17,26
20	7	2,0	20,70
24	8	3,3	24,12
28	9	5,2	30,06
32	10	7,5	37,76



COPERCHIO

Lid - Couvercle - Deckel - Tapa
Cod. 350030..

Ø cm	Euro
16	8,10
20	9,00
24	9,88
28	11,24
30	14,20
32	15,12
36	18,72
40	22,00
45	24,34
50	29,64
60	36,08



**PADELLA BASSA 4 mm**

Low frying pan - Poêle avec manche - Stielpfanne mit Griff - Sarten con mango
Cod. 374025..

Ø cm	h cm	lt	Euro
20	3,8	0,85	19,44
24	4,2	1,5	24,44
28	4,6	2,0	28,32
32	5,0	3,4	34,44
36	6,6	6,0	45,76
40	7,2	8,0	52,46
45	8,1	11,8	69,16

**PADELLA ALTA 4 mm**

Deep frying pan - Poêle avec manche - Stielpfanne mit Griff - Sarten con mango
Cod. 3740C5..

Ø cm	h cm	lt	Euro
20	4,6	1,2	20,26
24	5,0	1,8	25,28
28	5,7	2,8	30,26
32	6,5	4,6	38,58
36	8,0	7,3	49,72
40	8,5	9,7	55,26
45	9,5	14,0	74,70





TENDER ECLISSE

3509

Alluminio - Aluminum

Made in Italy 



-Serie professionale completa per il settore HORECA.
 -Tutti gli articoli sono prodotti in alluminio rivestito con copertura antiaderente WHITFORD ECLIPSE HB professionale, senza PFOA e idonea al contatto alimentare.

-I manici e le maniglie sono in tubolare d'acciaio inox 18/10 atermico e applicati con rivetti.

-Nickel Free.

-Ottimo per: cottura al salto, cotture lente e a fuoco moderato, cottura a parete.

-La forma di pentole e casseruole le rende impilabili.

-Per conservare il colore dell'alluminio è consigliato non lavare in lavastoviglie.

-Complete professional series for HORECA.

-All the items are made in Aluminium covered with non-stick coating WITHFORD ECLIPSE HB professional, PFOA free and suitable for contact with food.

-Riveted 18/10 (AISI 304) tubular stainless steel 18/10 (AISI 304) Handles and knobs.

-Nickel Free.

-Suitable for: Cuisson a sauter, Slow cooking, Browning.

-Stackable pots and casseroles.

-To preserve the color of aluminum is recommended do not wash in the dishwasher.



CASSERUOLA FONDA

deep casserole

Cod. 350905..

Ø cm	h cm	lt	Euro
20	11	3,0	44,30
24	14	5,6	58,02
28	16	8,8	66,40
32	18	13,1	81,78
36	20	18,7	94,54
40	22	25,6	110,44
45	25	37,1	132,92



CASSERUOLA BASSA

Deep casserole - Casserole avec 2 poignées - Fleischtopf - Cacerola honda 2 mangos

Cod. 350909..

Ø cm	h cm	lt	Euro
20	7	2,0	46,56
24	8	3,3	50,26
28	9	5,2	61,66
32	10	7,5	73,94
36	12	11,5	84,74
40	13	15,5	94,08
45	15	22,8	112,84



TEGAME

Frying pan 2 handles - Poêle avec 2 poignées - Pfanne mit 2 Griffen - Rustidera 2 mangos

Cod. 350923..

Ø cm	h cm	lt	Euro
28	6,0	3,15	51,12
32	6,5	4,25	61,12
36	7,0	6,35	69,68
40	7,2	8,5	78,68
45	8,0	12,5	84,56
50	8,5	15,5	98,52
60	9,0	26,5	117,28



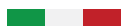

CASSERUOLA FONDA 1 MANICO

Deep saucepan - Casserole haute avec manche - Stielkasserolle - Cazo con mango
Cod. 350906..

Ø cm	h cm	lt	Euro
16	8	1,3	37,84
20	11	3,0	40,00
24	14	5,6	51,38
28	16	8,8	58,86
32	18	13,1	74,78



CASSERUOLA BASSA 1 MANICO

Low saucepan - Casserole avec 1 manche - Fleischtopf - Cacerola honda 1 mangos
Cod. 350910..

Ø cm	h cm	lt	Euro
16	6	1,1	34,68
20	7	2,0	37,44
24	8	3,3	45,12
28	9	5,2	54,08
32	10	7,5	66,86



PADELLA BASSA **4 mm**

Low frying pan - Poêle avec manche - Stielpfanne mit Griff - Sarten con mango
Cod. 374925..

Ø cm	h cm	lt	Euro
20	3,8	0,85	33,04
24	4,2	1,5	38,88
28	4,6	2,0	47,22
32	5,0	3,4	55,26
36	6,6	6,0	71,92
40	7,2	8,0	80,24
45	8,1	11,8	122,18



PADELLA ALTA **4 mm**

Deep frying pan - Poêle avec manche - Stielpfanne mit Griff - Sarten con mango
Cod. 3749C5..

Ø cm	h cm	lt	Euro
20	4,6	1,2	33,86
24	5,0	1,8	39,42
28	5,7	2,8	48,60
32	6,5	4,6	58,04
36	8,0	7,3	73,32
40	8,5	9,7	81,94
45	9,5	14,0	126,86







TENDER TOTAL BLACK 374L

Alluminio - Aluminum

Made in Italy 



-Serie professionale per il settore HORECA.

-Tutti gli articoli sono prodotti in alluminio rivestito con copertura antiaderente WHITFORD ECLIPSE HB professionale, senza PFOA e idonea al contatto alimentare.

-NOVITÀ: rivestimento antiaderente esterno WHITFORD ECLIPSE HB professionale, senza PFOA.

-I manici sono in tubolare d'acciaio inox 18/10 atermico, applicati con rivetti e con copertura in silicone.

-Nickel Free.

-Ottimo per: cottura al salto, cotture lente e a fuoco moderato, cottura a parete.

-Professional series for HORECA.

-All items are made in Aluminium with non-stick coating WHITFORD ECLIPSE HB professional, PFOA free and suitable for contact with food.

-NEWS: External non-stick coating with WHITFORD ECLIPSE HB PROFESSIONALE, PFOA free.

-Riveted 18/10 (AISI 304) tubular stainless steel 18/10 (AISI 304) handles with a silicone covering.

-Nickel Free.

-Suitable for: Cuisson a sauter, Slow cooking, Browning.

TENDER TOTAL BLACK

ALLUMINIO
ALUMINUM



PADELLA BASSA **4 mm**

Low frying pan - Poêle avec manche - Stielpfanne mit Griff - Sarten con mango
Cod. 374L25..

Ø cm	h cm	lt	Euro
20	3,8	0,85	36,30
24	4,2	1,5	44,14
28	4,6	2,0	49,72
32	5,0	3,4	58,04
36	6,6	6,0	74,68
40	7,2	8,0	83,10



PADELLA ALTA **4 mm**

Deep frying pan - Poêle avec manche - Stielpfanne mit Griff - Sarten con mango
Cod. 374LC5..

Ø cm	h cm	lt	Euro
20	4,6	1,2	39,70
24	5,0	1,8	46,92
28	5,7	2,8	52,48
32	6,5	4,6	66,36
36	8,0	7,3	77,48
40	8,5	9,7	88,56





TENDER ALU EASY

350

Alluminio - Aluminum



- Serie professionale per il settore HORECA.
- Tutti gli articoli sono prodotti con alluminio idoneo al contatto alimentare.
- I manici sono in tubolare d'acciaio inox 18/10 atermico e applicati con rivetti.
- Nickel Free.
- Ottimo per: cottura al salto, cotture lente e a fuoco moderato, cottura a parete.
- Antiaderente GREBLON COMPOUND professionale a 3 strati, **senza PFOA**.

- Professional series for HORECA.
- All the items are made in Aluminum suitable for contact with food.
- Riveted 18/10 (AISI 304) tubular stainless steel 18/10 (AISI 304) handles.
- Nickel Free.
- Suitable for: Cuisson a sauter, Slow cooking, Browning.
- Non-stick coating Aluminium frying pans with GREBLON COMPOUND Professional 3 layers, **PFOA free**.

TENDER ALU EASY

PADELLA BASSA CON ANTIADERENTE GREBLON

aluminum non-stick low frying pan

Cod. 350925..

Ø cm	h cm	Lt	master	Euro
20	4,0	1,0	6	15,72
24	4,5	1,6	6	21,90
28	5,2	2,6	6	25,90
32	6,0	4,0	6	31,30
36	6,7	5,7	6	37,14
40	7,5	7,9	6	43,54
45	8,4	11,2	6	59,72



PADELLA ALTA CON ANTIADERENTE GREBLON

aluminum non-stick deep frying pan

Cod. 3509C5..

Ø cm	h cm	Lt	master	Euro
20	4,7	1,2	6	16,62
24	5,4	2,0	6	23,16
28	6,3	3,3	6	28,08
32	7,2	5,0	6	33,24
36	8,1	7,1	6	40,94



PADELLA BASSA

aluminum low frying pan

Cod. 350025..

Ø cm	h cm	Lt	master	Euro
20	4,0	1,0	6	8,60
24	4,5	1,6	6	12,56
28	5,2	2,6	6	15,76
32	6,0	4,0	6	19,62
36	6,7	5,7	6	24,68
40	7,5	7,9	6	28,88
45	8,4	11,2	6	42,64



PADELLA ALTA

aluminum deep frying pan

Cod. 3500C5..

Ø cm	h cm	Lt	master	Euro
20	4,7	1,2	6	9,24
24	5,4	2,0	6	13,66
28	6,3	3,3	6	17,30
32	7,2	5,0	6	21,28
36	8,1	7,1	6	26,68





NEW

ST₁ ONE PRO



ST1-PRO. Corpo in alluminio coniato di spessore 4 mm, fondo Full Induction rettificato, rivestimento esterno verniciato nero, bordino rettificato, rivestimento antiaderente QUANTANIUM WHITFORD RAMATO (3 strati), manico in acciaio tubolare.

ST1-PRO. Forged aluminium body, 4 mm thickness; stainless steel full induction bottom, black finish outside, non-stick coating QUANTANIUM WHITFORD (3 layers) COPPER EFFECT, stainless steel stay-cool tubular handle.



Abrasion resistance
15.000 - 20.000 cycles
TEST TM 135 G (3 kg)

ST BLACK



ST-BLACK. Corpo in alluminio coniato di spessore 4 mm, fondo Full Induction rettificato, rivestimento esterno verniciato nero, bordino rettificato, rivestimento antiaderente ECLIPSE WHITFORD NERO (3 strati), manico in acciaio tubolare.

ST-BLACK. Forged aluminium body, 4 mm thickness; stainless steel full Induction bottom, black finish outside, BLACK non-stick coating ECLIPSE WHITFORD (3 layers), Stainless steel stay-cool tubular handle.



Abrasion resistance
30.000 - 60.000 cycles
TEST TM 135 G (3 kg)

ST ALU



ST-ALU. Corpo in alluminio coniato di spessore 4 mm, fondo Full Induction rettificato, rivestimento esterno non verniciato, bordino rettificato, rivestimento antiaderente ECLIPSE WHITFORD NERO (3 strati), manico in acciaio tubolare.

ST-ALU. Forged aluminium body, 4 mm thickness; stainless steel full Induction bottom, aluminium finish outside, BLACK non-stick coating ECLIPSE WHITFORD (3 layers), Stainless steel stay-cool tubular handle.



Abrasion resistance
30.000 - 60.000 cycles
TEST TM 135 G (3 kg)

ST1-PRO, ST-BLACK, ST-ALU



ST1-PRO

PADELLA

Frying pan - Poêle avec manche - Stielpfanne mit Griff - Sarten con mango
Cod. 397025..

Ø cm	Lt	Euro
20	1,1	20,90
24	1,9	26,98
26	2,4	29,98
28	3,0	34,30
32	3,5	39,98
36	5,1	46,90



ST-BLACK

PADELLA

Frying pan - Poêle avec manche - Stielpfanne mit Griff - Sarten con mango
Cod. 399025..

Ø cm	Lt	Euro
20	1,1	21,60
24	1,9	27,80
28	3,0	35,30
32	3,5	41,20
36	5,1	52,20



ST-ALU

PADELLA

Frying pan - Poêle avec manche - Stielpfanne mit Griff - Sarten con mango
Cod. 398025..

Ø cm	Lt	Euro
20	1,1	20,90
24	1,9	26,98
28	3,0	33,90
32	3,5	39,98
36	5,1	47,90





EXCALIBUR 3610

Ferro - Iron

Made in Italy 



- Produzione made in Italy.
- Alto spessore.
- Prodotto in ferro (Fe).
- Adatto a tutti i tipi di cucina.
- Ottimo per l'induzione.
- Manico ergonomico in acciaio rivettato.
- Nickel Free.
- Linea professionale adatta per: frittura, cottura alla piastra, arrostitura, brasatura, caramellatura.

- Made in Italy.*
- High tickness.*
- Item made in steel (Fe).*
- Suitable for all kind of cooktops.*
- Perfect for Induction use.*
- Riveted Ergonomic stainless steel handle.*
- Nickel Free.*
- Professional Series useful for: frying, grill cooking, oast cooking, brazing cooking, caramelization.*

PADELLA
 frying pan
 Cod. 361054..

Ø cm	h cm	Lt	Euro
12	2,2	0,20	18,06
18	3,35	0,63	21,18
20	3,75	0,85	21,48
22	3,7	1,07	22,96
24	4	1,35	23,58
26	4,35	1,75	26,68
28	4,7	2,20	28,10
30	5	2,74	31,50
32	5,4	3,30	31,84
34	5,75	4,03	37,96



PADELLA FONDA
 deep frying pan
 Cod. 3610C5..

Ø cm	h cm	Lt	Euro
24	7,65	2,70	32,68
28	8,6	4,15	41,78



TEGAME
 frying pan 2 handles
 Cod. 36102332

Ø cm	h cm	Lt	Euro
32	5,4	3,30	43,00



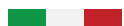

CREPIERE
crêpe frying pan
Cod. 361045..

Ø cm	h cm	Lt	Euro
20	1,25	0,36	21,18
24	1,5	0,60	23,26
28	1,75	0,90	27,06



WOK 2 MANIGLIE
wok with 2 handkes
Cod. 36109M36

Ø cm	h cm	Lt	Euro
36	11,9	7,1	81,56



WOK
wok
Cod. 36109F34

Ø cm	h cm	Lt	Euro
34	9,4	4,75	76,06



ESPOSITORE PER SERIE EXCALIBUR
Excalibur display
Cod. 99900149

largh.	prof.	altez.	Euro
48	48	204	502,26



Excalibur-Use instructions

Particolarmente versatili per la capacità del materiale di assicurare una temperatura uniforme e senza sbalzi in cottura, le padelle in ferro necessitano di una manutenzione specifica per conservarne inalterate le proprietà. Prima di tutto è necessario un pretrattamento per proteggerlo dall'ossidazione.

PRIMO UTILIZZO: BRUNITURA

-La padella va accuratamente lavata per qualche minuto con acqua calda e detersivo, in modo da rimuovere qualunque traccia dello strato protettivo con cui è venduta. Quindi va ben risciacquata e subito asciugata con uno strofinaccio e poi messa in forno a 70° finché non sarà completamente asciutta (in alternativa è possibile scaldarla su fiamma viva) e avrà assunto una colorazione grigia, tendente al blu.

-La padella di ferro teme gli sbalzi di temperatura, quindi abbiate l'accortezza di non inserirla nel forno già caldo e di farlo raffreddare all'interno del forno stesso.

-Con la padella ancora calda, passare con uno strofinaccio unto di olio di semi od altro olio da cucina.

-Passare poi la padella con un panno pulito, fino a quando non saranno rimosse tutte le tracce di olio e impurità.

-Rimettere la padella in forno a 70° (o su fiamma) per qualche minuto.

Al termine di questi passaggi non sarà più necessario lavare con acqua e detersivo la padella, ma sarà sufficiente pulirla ogni volta con carta assorbente o con uno straccetto unto. Qualora si rilevino tracce di sporco persistente procedere con le seguenti istruzioni. Con l'utilizzo l'articolo tende ad assumere una colorazione scura tendente al nero. Tale trasformazione superficiale è normale e conferisce al prodotto una proprietà antiaderente naturale. Tale patina contribuisce a proteggere la superficie dalla corrosione.

LAVAGGIO QUOTIDIANO:

-Lavare a mano con sola acqua calda, senza mai lasciarla in ammollo, eliminando i residui di cottura. In caso di residui incrostati utilizzare una spugna abrasiva. Asciugare immediatamente con un panno o carta assorbente.

-Ungere la padella con un panno unto di olio, e scaldare in forno a 70° (o su fiamma) per qualche minuto in modo da far asciugare lo strato d'olio. Lasciar raffreddare naturalmente.

-Conservare al riparo dall'umidità.

TRATTAMENTO DISINFETTANTE:

Saltuariamente trattare con il sale secondo le modalità seguenti. Tale trattamento serve per eliminare i residui delle cotture precedenti e gli odori, rendendo perfettamente secca la padella, con una leggera funzione abrasiva.

-Scaldare la padella con dell'olio, cospargerlo con sale grosso facendolo passare per 1 minuto e mezzo a fuoco vivo

-Strofinare la padella con della carta assorbente fino a eliminare i residui di cottura

-Scaldare di nuovo, ripetendo la procedura con del sale fino e strofinare nuovamente finché non risulterà pulito

-Scaldare ancora una volta la padella e ungerla con olio di semi od altro olio da cucina

-Riporre e conservare al riparo dell'umidità

N.B.:

-Il nemico principale della padella in ferro è la ruggine. Per evitare l'ossidazione, mai lasciarla in ammollo nell'acqua.

-Il sale è una delle principali cause della corrosione, assicurarsi di rimuoverne qualunque traccia durante l'omonimo trattamento, o durante l'uso quotidiano.

-Non surriscaldare mai su piastra ad induzione, per non danneggiare padella e piastra.

-Surriscaldare, o raffreddare, l'articolo troppo velocemente può danneggiarlo.

-Alimenti acidi (alcolici, limoni, pomodori...) potrebbero danneggiare lo strato di brunitura, facendo comparire chiazze biancastre. Se avviene sarà sufficiente ripetere la procedura del primo utilizzo.

-La padella in ferro va mantenuta sempre un po' unta, in modo che non arrugginisca.

NON METTERE MAI IN LAVASTOVIGLIE!

Particularly versatile due to their material's capacity to guarantee uniform temperature without sudden temperature change, iron pans require specific maintenance to preserve their features. Firstly, they require pre-treatment to protect them against oxidation.

USING FOR THE FIRST TIME: BURNISHING

-Clean the pan thoroughly with hot water and detergent for a few minutes, so as to remove any residual protection layer it is sold with. Next, rinse thoroughly and dry immediately using a cloth, then place it in an oven at 70° until it dries completely (you may also heat it on an open flame) and turns bluish-grey.

-The iron pan is sensitive to sudden temperature changes, so do not place it on a previously heated oven. Leave it to cool inside the oven.

-Using a cloth, rub the pan while still hot using seed oil or any other cooking oil.

-Next, wipe the pan using a clean cloth until it is entirely free of any oil and dirt residues.

-Place the pan in the oven at 70° (or flame) again for a few minutes.

Once through with these steps, do not wash the pan with water and detergent again. All you have to do is clean using kitchen paper towel or an oily cloth. In case of stubborn dirt residue, do as follows: With the daily use the pan will naturally turn to black. This change of the surface will give the pan a kind of natural non-stick property. Moreover it would help to protect the surface from corrosion.

DAILY WASHING:

-Without leaving it to soak, hand-wash using hot water only to eliminate cooking residues. Use an abrasive sponge in case of burnt-on stains. Dry immediately using a cloth or kitchen paper towel.

-Oil the pan using an oily cloth, then heat in an oven at 70° (or open flame) for a few minutes to dry off the oil layer. Leave it to cool naturally.

-Keep away from moisture.

DISINFECTION:

Occasionally treat with salt as follows: This treatment helps eliminating previous cooking residues and odours, thus leaving the pan completely dry, with a slight abrasive function.

-Heat the pan using oil, sprinkle some coarse salt on it and leave it on an open flame for one and half minutes.

-Rub the pan using kitchen paper towel to eliminate cooking residues.

-Heat once again, repeating the procedure with fine salt and rub once again until it is completely clean

-Using a cloth, rub the pan once again using seed oil or any other cooking oil.

-Put it away and keep away from moisture

N.B.:

-The iron pan is particularly sensitive to rust. Do not leave the pan soaked with water to avoid oxidation.

-Salt is one of the main causes of rust, hence ensure no traces of salt are left during the treatment using it or during daily use of the pan.

-Do not overheat on an induction plate to avoid damaging both the pan and induction plate.

-Too rapid heating and too rapid cooling may damage the pan.

-Acidic foodstuffs (alcohols, lemon, tomatoes...) they could damage the burnishing layer, thus causing whitish stains. Just repeat the "using for the first time" procedure if this happens.

-The iron pan must always be kept oiled to prevent rust.

DO NOT WASH IN DISHWASHER!



RAME Copper 3640

Rame 99% - Copper 99%

Stagno 99% - Tin 99 %

Made in Italy 



- Produzione made in Italy.
- Rame puro al 99%
- Stagno puro al 99%
- Prodotta con materiali certificati e idonei al contatto alimentare.
- L'altissima conducibilità termica del rame garantisce un'ottima precisione nella regolazione della temperatura.
- Indispensabile nel settore della pasticceria.
- Altissimo risparmio energetico.
- Nickel free.

- Made in Italy.*
- Pure Copper at 99%*
- Pure Tin at 99%*
- All the items are made with Certificated material approved for food contact.*
- The high Thermal conductivity of copper ensures excellent precision in adjusting the temperature.*
- Indispensable for pastry makers.*
- Highest energy savings.*
- Nickel free.*



CASSERUOLA ALTA
deep casserole
Cod. 364005..

Ø cm	h cm	Lt	Euro
14	7,5	1,1	55,16
16	9	1,6	61,54
20	15	3,7	165,50
24	15	5,5	197,32



CASSERUOLA BASSA
low casserole
Cod. 364009..

Ø cm	h cm	Lt	Euro
20	9	2,4	142,14
24	10,5	3,7	152,76
30	10	5,5	207,94
36	7,5	7,8	212,18



TEGAME 2 MANIGLIE
roasting pan
Cod. 364023..

Ø cm	h cm	Lt	Euro
18	4,5	0,85	58,36
24	5	1,65	83,82
28	6	2,05	100,80
32	6	3,2	116,70
36	6	3,6	200,52



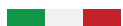

CASSERUOLA 1 MANICO

saucepan

Cod. 364006..

Ø cm	h cm	Lt	Euro
8	5	0,21	33,32
10	6	0,37	36,70
12	6	0,5	39,24
14	7,5	1,1	55,16
16	9	1,6	61,54



PADELLA

frying pan

Cod. 364025..

Ø cm	h cm	Lt	Euro
18	4,5	0,85	59,42
22	4,5	1,0	68,96
24	5	1,65	83,82
26	5,5	1,8	91,24
28	6	2,05	100,80
32	6	3,2	116,70
36	6	3,6	199,28



PAIOLO CON MANICO IN ACCIAIO

cauldron with stainless steel handle

Cod. 36407026

Ø cm	h cm	lt	Euro
26	14	4,5	80,62





COPERCHIO

lid

Cod. 364035..

Ø cm	Euro
12	20,16
14	26,00
16	31,30
20	37,66
24	43,50
28	58,36
30	60,48
32	70,02
36	95,48



LISTINO RISTAGNATURA

Copper cookware retinning price list

casseroles	Ø cm	Euro
	14	28,84
	16	35,02
	20	45,32
	24	61,60
	30	74,16
	36	86,52

padelle e tegami	Ø cm	Euro
<i>frying pans and</i>	18	24,72
<i>roasting pans</i>	22	25,76
	24	32,96
	26	41,20
	28	46,36
	32	49,44
	36	57,68



SERIE FORNO

Oven

TEGLIA RETTANGOLARE

Roasting Pan - Plat à Rôti - Fleischkasten - Rustidera Horno

Cod. 548106..

cm	h cm	Euro
25x18	7	36,58
30x21	7	40,90
35x25	7	48,26



COPERCHIO PER TEGLIA

Lid for roasting pan - Couvercle pour plat à rôti - Deckel für Fleischkasten - Tapa para rustidera horno

Cod. 548128..

cm	Euro
25x18	23,16
30x21	26,62
35x25	33,10



TEGLIA PESANTE SPESSORE 2 mm

2 mm thick heavy roasting pan - Plat à rôti, ép. 2 mm -

Fleischkasten extra schwer 2 mm - Rustidera horno esp. 2 mm

Cod. 509004..

cm	h cm	Euro
45x30	9	214,06
50x40	9	258,96
70x45	9	393,02



TEGLIA SATINATA

Satin roasting pan - Plat à rôti satiné - Fleischkasten satiniert - Rustidera horno satinado
Cod. 509003..

cm	h cm	Euro
40x30	8	69,40
50x35	9	82,18
60x40	10	117,26



COPERCHIO SATINATO PER TEGLIA SOVRAPPONIBILE

Satin lid for roasting pan - Couvercle satiné pour plat à rôti -
Deckel satiniert für Fleischkasten - Tapa satinado para rustidera horno
Cod. 509006..

cm	Euro
40x30	47,74
50x35	52,90
60x40	56,72



CUOCIPESCE MONOFONDO

Composto da 3 pezzi:
cuocipesce, coperchio con maniglia, griglia.
Consisting of 3 pcs:
Fishkettle, Lid with handle, Grill.
Composé de 3 pièces:
Poissonnière, Couvercle avec poignée, Grille
Besteht aus 3 Teilen:
Fischkochkessel, Deckel mit Griff, Siebeinsatz.
Compuesto de 3 piezas:
Besuguera, Tapa, Rejilla.
Cod. 308882..

cm	h cm	Lt	Euro
40	10,8	6,00	84,88
50	11,0	8,50	105,04
60	11,0	10,35	125,18



TEGAME UOVO

French omelet pan - Poêle à oeufs - Eierservierschüssel - Paellera huevo
Cod. 50901516

Ø cm	h cm	Euro
16	2	13,76



LUMACHIERA INOX

Snails plate - Plat à escargots - Schneckenplatte - Plato para caracoles
Cod. 509155..

Ø cm	posti	Euro
14	6	7,06
20	12	9,06





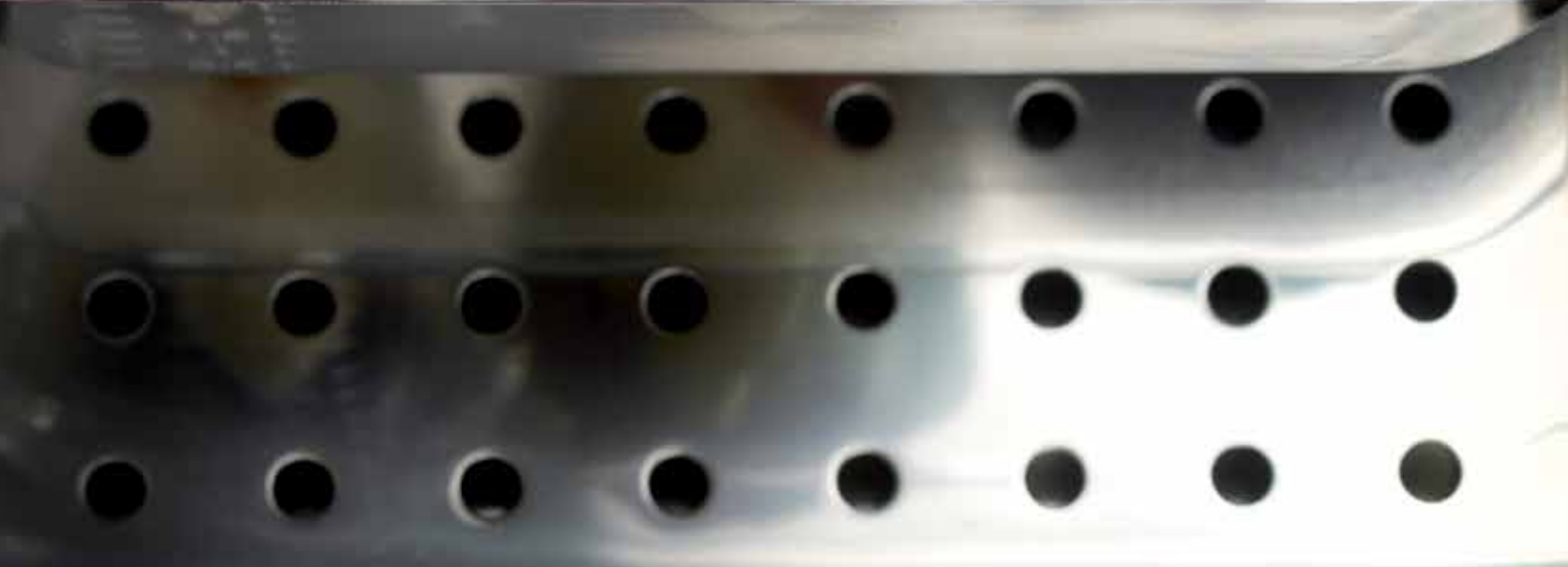

G A S T R O N O R M



Per alimenti
Suitable for foodstuffs
Apte au contact avec les aliments
Für Lebensmittel
Apto para alimentos



Garantito per lavastoviglie
Dishwasher safe
Inalterable dans lave-vaisselle
Spelmaschinenfest
Apto para lavavajillas



GASTRONORM



È la rivoluzione in cucina, perché tutte le pezzature sono multipli e sottomultipli tra di loro, permettendo tutte le combinazioni dimensionali richieste dalla ristorazione. La compatibilità con la gamma in policarbonato rende le due serie ancora più performanti nel trasporto, nella presentazione e la conservazione degli alimenti.

This is a kitchen revolution because all the sizes are multiples and submultiples of each other, giving all size combinations as required by the catering industry. Compatibility with the polycarbonate range means the two series perform even better in the transportation, presentation and conservation of food.

BACINELLE SOVRAPPONIBILI

INOX
18/10

Stackable basins

BACINELLA SOVRAPPONIBILE MOD. 2/1

Stackable basin model 2/1 - Bac empilable mod 2/1

Stapelbare schüssel mod 2/1 - Bandeja honda apilable mod. 2/1

IN mm 620x500 OUT mm 650x530

Cod.	h mm	Capacity Lt	Euro
5BA21200	200	58,0	157,04
5BA21150	150	42,8	139,42
5BA21100	100	30,0	99,18
5BA21065	65	18,0	83,82
5BA21040	40	-	71,94
5BA21020	20	-	68,36



BACINELLA SOVRAPPONIBILE MOD. 1/1

Stackable basin model 1/1 - Bac empilable mod 1/1

Stapelbare schüssel mod 1/1 - Bandeja honda apilable mod. 1/1

IN mm 500x295 OUT mm 530x325

Cod.	h mm	Capacity Lt	Euro
5BA11200	200	27,5	87,94
5BA11150	150	20,0	75,40
5BA11100	100	13,7	52,04
5BA11065	65	8,8	39,36
5BA11040	40	-	35,48
5BA11020	20	-	29,84



BACINELLA SOVRAPPONIBILE MOD. 2/3

Stackable basin model 2/3 - Bac empilable mod 2/3

Stapelbare schüssel mod 2/3 - Bandeja honda apilable mod. 2/3

IN mm 330x300 OUT mm 355x325

Cod.	h mm	Capacity Lt	Euro
5BA23200	200	17,0	70,64
5BA23150	150	13,0	60,46
5BA23100	100	9,0	38,20
5BA23065	65	5,8	29,22
5BA23040	40	-	25,76
5BA23020	20	-	22,62



BACINELLE SOVRAPPONIBILI

BACINELLA SOVRAPPONIBILE MOD. 1/2

Stackable basin model 1/2 - Bac empilable mod 1/2

Stapelbare schüssel mod 1/2 - Bandeja honda apilable mod. 1/2

IN mm 298x238 OUT mm 325x265

Cod.	h mm	Capacity Lt	Euro
5BA12200	200	12,0	56,14
5BA12150	150	9,2	44,56
5BA12100	100	6,1	29,84
5BA12065	65	4,0	23,92
5BA12040	40	-	20,88
5BA12020	20	-	19,26



BACINELLA SOVRAPPONIBILE MOD. 1/3

Stackable basin model 1/3 - Bac empilable mod 1/3

Stapelbare schüssel mod 1/3 - Bandeja honda apilable mod. 1/3

IN mm 300x150 OUT mm 325x175

Cod.	h mm	Capacity Lt	Euro
5BA13200	200	7,2	47,28
5BA13150	150	5,4	34,74
5BA13100	100	3,5	25,22
5BA13065	65	2,4	21,10



BACINELLA SOVRAPPONIBILE MOD. 1/4

Stackable basin model 1/4 - Bac empilable mod 1/4

Stapelbare schüssel mod 1/4 - Bandeja honda apilable mod. 1/4

IN mm 238x137 OUT mm 264x162

Cod.	h mm	Capacity Lt	Euro
5BA14200	200	4,8	39,14
5BA14150	150	3,8	29,54
5BA14100	100	2,5	21,64
5BA14065	65	1,7	19,36
5BA14040	40	-	18,06
5BA14020	20	-	17,30



BACINELLA SOVRAPPONIBILE MOD. 2/4

Stackable basin model 2/4 - Bac empilable mod 2/4

Stapelbare schüssel mod 2/4 - Bandeja honda apilable mod. 2/4

IN mm 500x136 OUT 530x162 mm

Cod.	h mm	Capacity Lt	Euro
5BA24150	150	8,6	60,78
5BA24100	100	5,8	43,06
5BA24065	65	4,0	31,58
5BA24040	40	-	27,16
5BA24020	20	-	22,50



BACINELLA SOVRAPPONIBILE MOD. 2/8

Stackable basin model 2/8 - Bac empilable mod 2/8

Stapelbare schüssel mod 2/8 - Bandeja honda apilable mod. 2/8

IN mm300x107 OUT mm325x132

Cod.	h mm	Capacity Lt	Euro
5BA28150	150	3,9	36,78
5BA28100	100	2,6	28,56
5BA28065	65	1,7	22,18
5BA28040	40	-	19,80
5BA28020	20	-	17,74



BACINELLA SOVRAPPONIBILE MOD. 1/6

Stackable basin model 1/6 - Bac empilable mod 1/6

Stapelbare schüssel mod 1/6 - Bandeja honda apilable mod. 1/6

IN mm153x140 OUT mm 176x162

Cod.	h mm	Capacity Lt	Euro
5BA16200	200	3,5	48,88
5BA16150	150	2,3	29,74
5BA16100	100	1,5	18,72
5BA16065	65	1,0	15,70
5BA16040	40	-	14,60
5BA16020	20	-	11,68



BACINELLA SOVRAPPONIBILE MOD. 1/9

Stackable basin model 1/9 - Bac empilable mod 1/9

Stapelbare schüssel mod 1/9 - Bandeja honda apilable mod. 1/9

IN mm 150x93 OUT mm 176x108

Cod.	h mm	Capacity Lt	Euro
5BA19100	100	0,8	21,00
5BA19065	65	0,6	15,90



BACINELLE - TEGLIE

Alluminio con bordo - Interno teflonato

TEGLIA ALLUMINIO CON BORDO. INTERNO TEFLONATO MOD. 1/1

Non-stick aluminium basin, with edge model 1/1

Bac antiadhérent en alu, avec bord mod 1/1

Backform aus alum., antihftbeschichtet mod 1/1

Rustidera alum. con borde, interior teflon mod. 1/1

IN mm 500x295 OUT mm 530x325

Cod.	h mm	Capacity Lt	Euro
5TAT1102	20	-	54,84
5TAT1104	40	-	62,08
5TAT1165	65	8,8	72,24



TEGLIA ALLUMINIO CON BORDO. INTERNO TEFLONATO MOD. 2/3

Non-stick aluminium basin, with edge model 2/3

Bac antiadhérent en alu, avec bord mod 2/3

Backform aus alum., antihftbeschichtet mod 2/3

Rustidera alum. con borde, interior teflon mod. 2/3

IN mm 330x300 OUT mm 355x325

Cod.	h mm	Capacity Lt	Euro
5TAT2302	20	-	38,84
5TAT2304	40	-	42,62
5TAT2365	65	5,8	50,94



TEGLIA ALLUMINIO CON BORDO. INTERNO TEFLONATO MOD. 1/2

Non-stick aluminium basin, with edge model 1/2

Bac antiadhérent en alu, avec bord mod 1/2

Backform aus alum., antihftbeschichtet mod 1/2

Rustidera alum. con borde, interior teflon mod. 1/2

IN mm 236x325 OUT mm 355x325

Cod.	h mm	Capacity Lt	Euro
5TAT1202	20	-	32,56
5TAT1204	40	-	35,70
5TAT1265	65	4,0	41,52



Perforated stackable basins

BACINELLA FORATA MOD. 2/1

Perforated stackable basin model 2/1 - Bac perforé empilable mod 2/1

Stapelbare Schüssel mit Löchern mod 2/1 - Bandeja honda perforada apilable mod. 2/1

IN mm 620x500 OUT mm 650x530

Cod.	h mm	Capacity Lt	Euro
5BF21200	200	58,0	293,92
5BF21150	150	42,8	243,28
5BF21100	100	30,0	169,80
5BF21065	65	18,0	120,38
5BF21040	40	-	108,78
5BF21020	20	-	105,98



BACINELLA FORATA MOD. 1/1

Perforated stackable basin model 1/1 - Bac perforé empilable mod 1/1

Stapelbare Schüssel mit Löchern mod 1/1 - Bandeja honda perforada apilable mod. 1/1

IN mm 500x295 OUT mm 530x325

Cod.	h mm	Capacity Lt	Euro
5BF11200	200	27,8	159,00
5BF11150	150	20,0	129,48
5BF11100	100	13,7	81,22
5BF11065	65	8,8	56,04
5BF11040	40	-	45,22
5BF11020	20	-	39,70



BACINELLA FORATA MOD. 2/3

Perforated stackable basin model 2/3 - Bac perforé empilable mod 2/3

Stapelbare Schüssel mit Löchern mod 2/3 - Bandeja honda perforada apilable mod. 2/3

IN mm 330x300 OUT mm 355x325

Cod.	h mm	Capacity Lt	Euro
5BF23200	200	17,0	113,94
5BF23150	150	13,0	94,46
5BF23100	100	9,0	62,84
5BF23065	65	5,8	36,02
5BF23040	40	-	31,90
5BF23020	20	-	30,08



BACINELLA FORATA MOD. 1/2

Perforated stackable basin model 1/2 - Bac perforé empilable mod 1/2

Stapelbare Schüssel mit Löchern mod 1/2 - Bandeja honda perforada apilable mod. 1/2

IN mm 298x238 OUT mm 325x265

Cod.	h mm	Capacity Lt	Euro
5BF12200	200	12,0	93,24
5BF12150	150	9,2	75,60
5BF12100	100	6,1	48,46
5BF12065	65	4,0	31,90
5BF12040	40	-	28,56
5BF12020	20	-	27,26



BACINELLA FORATA MOD. 1/3

Perforated stackable basin model 1/3 - Bac perforé empilable mod 1/3

Stapelbare Schüssel mit Löchern mod 1/3 - Bandeja honda perforada apilable mod. 1/3

IN mm 300x150 OUT mm 325x175

Cod.	h mm	Capacity Lt	Euro
5BF13200	200	7,2	77,50
5BF13150	150	5,4	55,16
5BF13100	100	3,5	41,20
5BF13065	65	2,4	25,52



BACINELLA FORATA INCASSO MOD. 1/1

Perforated insertable basin model 1/1 - Bac perforé à encastrement mod 1/1

Schüssel mit Löchern, versenkt mod 1/1 - Bandeja honda perforada de Encastrar mod. 1/1

IN mm 500x295 OUT mm 530x325

Cod.	h mm	Capacity Lt	Euro
5BI11090	90	10,6	81,12
5BI11055	55	6,5	51,80

foto dimostrativa
sample photo

TEGLIE

INOX
18/10

Trays

TEGLIA MOD. 2/1 BORDO PIANO

Tray 2/1 flat edge - Bac à four 2/1 bord plat

Fleischkasten 2/1 mit flachem Rand - Rustidera horno 2/1 bordo llana

IN mm 620x500 OUT mm 650x530

Cod.	h mm	Capacity Lt	Euro
5TI21065	65	18,0	83,82
5TI21040	40	11,2	71,94
5TI21020	20	5,6	68,36



TEGLIA MOD. 1/1 BORDO PIANO

Tray 1/1 flat edge - Bac à four 1/1 bord plat

Fleischkasten 1/1 mit flachem Rand - Rustidera horno 1/1 bordo llana

IN mm 500x295 OUT mm 530x325

Cod.	h mm	Capacity Lt	Euro
5TI11065	65	8,8	39,36
5TI11040	40	5,3	35,38
5TI11020	20	2,6	29,84



TEGLIA MOD. 2/3 BORDO PIANO

Tray 2/3 flat edge - Bac à four 2/3 bord plat

Fleischkasten 2/3 mit flachem Rand - Rustidera horno 2/3 bordo llana

IN mm 300x300 OUT mm 355x325

Cod.	h mm	Capacity Lt	Euro
5TI23065	65	5,8	29,22
5TI23040	40	3,7	25,76
5TI23020	20	1,7	22,62



TEGLIA MOD. 1/2 BORDO PIANO

Tray 1/2 flat edge - Bac à four 1/2 bord plat

Fleischkasten 1/2 mit flachem Rand - Rustidera horno 1/2 bordo llana

IN mm 298x238 OUT mm 325x265

Cod.	h mm	Capacity Lt	Euro
5TI12065	65	4,0	24,34
5TI12040	40	2,4	21,10
5TI12020	20	1,2	19,70



BACINELLE

Basins

BACINELLA CON MANIGLIE RIENTRANTI

Basin with retractable handles - Bac avec anses rentrantes

Schüssel mit Fallgriffen - Bandeja honda con mangos entrantes

Cod.	mod.	IN mm	OUT mm	h mm	Capacity Lt	Euro
5BR11200	1/1			200	27,8	97,56
5BR11150	1/1	500x295	530x325	150	20,0	85,02
5BR11100	1/1			100	13,7	61,60

Cod.	mod.	IN mm	OUT mm	h mm	Capacity Lt	Euro
5BR23200	2/3			200	17,0	80,26
5BR23150	2/3	330x300	355x325	150	13,0	70,02
5BR23100	2/3			100	9,0	47,90

Cod.	mod.	IN mm	OUT mm	h mm	Capacity Lt	Euro
5BR12200	1/2			200	12,0	65,66
5BR12150	1/2	298x238	325x265	150	9,2	54,20
5BR12100	1/2			100	6,1	33,44

Cod.	mod.	IN mm	OUT mm	h mm	Capacity Lt	Euro
5BR13200	1/3			200	7,2	56,82
5BR13150	1/3	300x150	325x175	150	5,4	44,54
5BR13100	1/3			100	3,5	34,78

Cod.	mod.	IN mm	OUT mm	h mm	Capacity Lt	Euro
5BR14200	1/4			200	4,8	47,30
5BR14150	1/4	238x137	264x162	150	3,8	39,46
5BR14100	1/4			100	2,5	31,30



particolare
maniglie rientranti
*detail of
retractable handles*

Lids

COPERCHIO NORMALE

Normal lid - Couvercle - Normaler Deckel - Tapa

Cod.	mod.	Euro
5CO11000	1/1	33,74
5CO23000	2/3	23,36
5CO12000	1/2	20,02
5CO13000	1/3	15,70
5CO14000	1/4	13,10
5CO24000	2/4	11,90
5CO28000	2/8	11,90
5CO16000	1/6	11,24
5CO19000	1/9	8,12



COPERCHIO NORMALE CON SPACCO PER MESTOLO

Normal lid with ladle slot - Couvercle avec fente pour louche

Normaler Deckel mit Schlitz für Suppenschöpfer - Tapa con hendidura para cazo

Cod.	mod.	Euro
5CSME110	1/1	37,32
5CSME230	2/3	26,26
5CSME120	1/2	23,80
5CSME130	1/3	19,36
5CSME140	1/4	16,96
5CSME160	1/6	14,80



COPERCHIO NORMALE CON SPACCO PER MANIGLIE

Normal lid with handle slot - Couvercle avec fente pour anses

Normaler Deckel mit Schlitz für Griffen - Tapa con hendidura para mangos

Cod.	mod.	Euro
5CSMA110	1/1	37,32
5CSMA230	2/3	27,04
5CSMA120	1/2	23,80
5CSMA130	1/3	19,36
5CSMA140	1/4	16,96
5CSMA160	1/6	15,24



COPERCHIO NORMALE CON SPACCO PER MESTOLO E MANIGLIE

Normal Lid with ladle and handle slot

Couvercle avec fente pour louche et anses

Normaler Deckel mit Schlitz für Griffen und Suppenschöpfer

Tapa con hendidura para cazo y mangos

Cod.	mod.	Euro
5CSMM110	1/1	40,90
5CSMM230	2/3	30,72
5CSMM120	1/2	27,92
5CSMM130	1/3	23,00
5CSMM140	1/4	21,10
5CSMM160	1/6	19,80



COPERCHIO A TENUTA CON GUARNIZIONE AL SILICONE

Sealing lid with silicone gasket - Couvercle à etanche avec garniture

Deckel mit Silikondichtung - Tapa estanca con junta s

Cod.	mod.	Euro
5CT11000	1/1	109,24
5CT23000	2/3	36,54
5CT12000	1/2	77,66
5CT13000	1/3	27,22
5CT14000	1/4	21,84
5CT16000	1/6	18,98



COPERCHIO A TENUTA CON SPACCO PER MANIGLIE

Sealing lid with handle slot - Couvercle à etanche, avec fente

Deckel mit Schlitz für Griffen - Tapa estanca con hendidura para mangos

Cod.	mod.	Euro
5CTSM110	1/1	113,56
5CTSM230	2/3	84,36
5CTSM120	1/2	81,44
5CTSM130	1/3	69,88
5CTSM140	1/4	56,78



FALSI FONDI-SEPARATORI- VASSOI A SCOMPRTO

FALSO FONDO FORATO

False perforated bottom - Faux-fond perforé - Falscher Boden mit Löchern - Falso hondo perforado

Cod.	mod.	Euro
5FF11000	1/1	43,82
5FF23000	2/3	33,44
5FF12000	1/2	28,88
5FF21000	2/1	70,52



SEPARATORE

Divider - Séparateur - Teiler - Separador

Cod.	mm	Euro
5SE11000	530	5,32
5SE12000	325	3,58



VASSOIO 4 SCOMPARTI BORDO PIANO SENZA PIEDINI

Tray with 4 sectors, flat edge without feet - Plateau 4 secteurs, bord plat
Tablett mit 4 Sektoren und flachem Rand ohne Füße - Bandeja 4 secciones, bordo llano, sin pies

Cod.	mm	Euro
5VS4BPSP	400x300	37,86



VASSOIO 5 SCOMPARTI BORDO PIANO SENZA PIEDINI

Tray with 5 sectors, flat edge without feet - Plateau 5 secteurs, bord plat
Tablett mit 5 Sektoren und flachem Rand ohne Füße - Bandeja 5 secciones, bordo llano, sin pies

Cod.	mm	h mm	Euro
5VS5BPSP	400x350	20	41,00



POLICARBONATO

Polycarbonate

BACINELLA SOVRAPPONIBILE MOD. 1/1

Stackable basin model 1/1 - Bac empilable mod 1/1

Stapelbare schüssel mod 1/1 - Bandeja honda apilable mod. 1/1

Cod.	h mm	Euro
5BP11200	200	42,44
5BP11150	150	32,90
5BP11100	100	26,04
5BP11065	65	22,82



BACINELLA SOVRAPPONIBILE MOD. 1/2

Stackable basin model 1/2 - Bac empilable mod 1/2

Stapelbare schüssel mod 1/2 - Bandeja honda apilable mod. 1/2

Cod.	h mm	Euro
5BP12200	200	22,82
5BP12150	150	19,38
5BP12100	100	15,36
5BP12065	65	13,44



BACINELLA SOVRAPPONIBILE MOD. 1/3

Stackable basin model 1/3 - Bac empilable mod 1/3

Stapelbare schüssel mod 1/3 - Bandeja honda apilable mod. 1/3

Cod.	h mm	Euro
5BP13200	200	19,16
5BP13150	150	15,72
5BP13100	100	12,62
5BP13065	65	11,16



POLICARBONATO

BACINELLA SOVRAPPONIBILE MOD. 1/4

Stackable basin model 1/4 - Bac empilable mod 1/4

Stapelbare schüssel mod 1/4 - Bandeja honda apilable mod. 1/4

Cod.	h mm	Euro
5BP14200	200	17,34
5BP14150	150	15,50
5BP14100	100	11,54
5BP14065	65	9,70



BACINELLA SOVRAPPONIBILE MOD. 1/6

Stackable basin model 1/6 - Bac empilable mod 1/6

Stapelbare schüssel mod 1/6 - Bandeja honda apilable mod. 1/6

Cod.	h mm	Euro
5BP16200	200	13,70
5BP16150	150	9,16
5BP16100	100	7,68
5BP16065	65	6,68



BACINELLA SOVRAPPONIBILE MOD. 1/9

Stackable basin model 1/9 - Bac empilable mod 1/9

Stapelbare schüssel mod 1/9 - Bandeja honda apilable mod. 1/9

Cod.	h mm	Euro
5BP19100	100	6,46
5BP19065	65	5,42



POLICARBONATO

BACINELLA SOVRAPPONIBILE MOD. 2/1

Stackable basin model 2/1 - Bac empilable mod 2/1

Stapelbare schüssel mod 2/1 - Bandeja honda apilable mod. 2/1

Cod.	h mm	Euro
5BP21200	200	85,14



COPERCHIO

Lid - Couvercle - Deckel - Tapa

Cod.	mod.	Euro
5CP21000	2/1	39,60
5CP11000	1/1	16,98
5CP12000	1/2	13,44
5CP13000	1/3	8,24
5CP14000	1/4	7,38
5CP16000	1/6	4,82
5CP19000	1/9	4,22



FALSO FONDO FORATO

False perforated bottom - Faux-fond perforé - Falscher Boden mit Löchern -

Falso hondo perforado

Cod.	mod.	Euro
5FP21000	2/1	40,74
5FP11000	1/1	10,54
5FP12000	1/2	6,40





TENDER GASTRONORM

**Vendita solo a Master
Only master selling**

Made in Italy 

La serie Gastronorm Tender è caratterizzata da un ottimo rapporto qualità/prezzo. Le caratteristiche principali sono le seguenti:

- Produzione totalmente italiana.
- Tutti i materiali impiegati sono della migliore qualità e idonei al contatto alimentare ai sensi del DM 25/01/1992 art. 4 – 5° comma e della DIR. CEE 89/109.
- Tutte le misure più grandi sono normalizzate a garanzia di una maggiore resistenza dell'articolo.
- Massima capienza nel minimo ingombro grazie all'ottimizzazione delle raggature.
- Bordi smerigliati per una maggior sicurezza nell'utilizzo.
- Ogni articolo confezionato in busta trasparente.

Gastronorm new TENDER series is a perfect combination of price and quality. Main Technical characteristics

- All the series are Made in Italy.
- All the material used in mass production are suitable for food contacts as for the law DM 25/01/1992 art. 4 – 5° comma and DIR. CEE 89/109.
- All the big sizes are done with special operation for improving resistance.
- Sizes are done to reduce as much as possible the volume, they are stackable.
- Borders are done to avoid any personal damages during use.
- Every piece is in a transparent polybag.

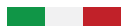

BACINELLE SOVRAPPONIBILI

Stackable basins

BACINELLA SOVRAPPONIBILE MOD. 2/1

Stackable basin model 2/1 - Bac empilable mod 2/1

Stapelbare schüssel mod 2/1 - Bandeja honda apilable mod. 2/1

IN mm 620x500 OUT mm 650x530

Cod.	h mm	Capacity Lt	master	Euro master
7BA21200	200	58,0	1	111,74
7BA21150	150	42,8	1	99,18
7BA21100	100	30,0	1	70,20
7BA21065	65	18,0	1	59,50
7BA21040	40	-	1	50,94
7BA21020	20	-	1	48,34



BACINELLA SOVRAPPONIBILE MOD. 1/1

Stackable basin model 1/1 - Bac empilable mod 1/1

Stapelbare schüssel mod 1/1 - Bandeja honda apilable mod. 1/1

IN mm 500x295 OUT mm 530x325

Cod.	h mm	Capacity Lt	(Euro pcs)	master	Euro master
7BA11200	200	27,5	59,24	6	366,10
7BA11150	150	20,0	51,66	6	319,26
7BA11100	100	13,7	32,87	6	203,12
7BA11065	65	8,8	24,87	6	153,70
7BA11040	40	-	22,50	12	278,14
7BA11020	20	-	21,04	12	260,06



BACINELLA SOVRAPPONIBILE MOD. 2/3

Stackable basin model 2/3 - Bac empilable mod 2/3

Stapelbare schüssel mod 2/3 - Bandeja honda apilable mod. 2/3

IN mm 330x300 OUT mm 355x325

Cod.	h mm	Capacity Lt	(Euro pcs)	master	Euro master
7BA23200	200	17,0	49,92	6	308,50
7BA23150	150	13,0	41,89	12	517,72
7BA23100	100	9,0	26,78	6	165,48
7BA23065	65	5,8	18,50	6	114,34
7BA23040	40	-	16,43	12	203,12
7BA23020	20	-	15,95	24	394,22



BACINELLE SOVRAPPONIBILI

**INOX
18/10**

SOLO
VENDITA
MASTER
ONLY
MASTER
SELLING



BACINELLA SOVRAPPONIBILE MOD. 1/2

Stackable basin model 1/2 - Bac empilable mod 1/2

Stapelbare schüssel mod 1/2 - Bandeja honda apilable mod. 1/2

IN mm 298x238 OUT mm 325x265

Cod.	h mm	Capacity Lt	(Euro pcs)	master	Euro master
7BA12200	200	12,0	38,80	12	479,54
7BA12150	150	9,2	32,60	12	402,92
7BA12100	100	6,1	19,14	12	236,58
7BA12065	65	4,0	15,36	12	189,80
7BA12040	40	-	13,24	12	163,64
7BA12020	20	-	12,11	24	299,36



BACINELLA SOVRAPPONIBILE MOD. 1/3

Stackable basin model 1/3 - Bac empilable mod 1/3

Stapelbare schüssel mod 1/3 - Bandeja honda apilable mod. 1/3

IN mm 300x150 OUT mm 325x175

Cod.	h mm	Capacity Lt	(Euro pcs)	master	Euro master
7BA13200	200	7,2	33,50	12	414,00
7BA13150	150	5,4	24,57	12	303,68
7BA13100	100	3,5	16,13	12	199,32
7BA13065	65	2,4	13,39	12	165,48



BACINELLA SOVRAPPONIBILE MOD. 1/4

Stackable basin model 1/4 - Bac empilable mod 1/4

Stapelbare schüssel mod 1/4 - Bandeja honda apilable mod. 1/4

IN mm 238x137 OUT mm 264x162

Cod.	h mm	Capacity Lt	(Euro pcs)	master	Euro master
7BA14200	200	4,8	27,76	12	343,06
7BA14150	150	3,8	20,89	12	258,20
7BA14100	100	2,5	13,73	12	169,64
7BA14065	65	1,7	11,48	12	141,86
7BA14040	40	-	10,69	12	132,12
7BA14020	20	-	10,54	24	260,48



BACINELLA SOVRAPPONIBILE MOD. 2/4

Stackable basin model 2/4 - Bac empilable mod 2/4

Stapelbare schüssel mod 2/4 - Bandeja honda apilable mod. 2/4

IN mm 500x136 OUT 530x162 mm

Cod.	h mm	Capacity Lt	(Euro pcs)	master	Euro master
7BA24150	150	8,6	43,05	12	532,10
7BA24100	100	5,8	30,45	12	376,36
7BA24065	65	4,0	21,89	12	270,50
7BA24040	40	-	19,13	24	472,86
7BA24020	20	-	15,92	24	393,56



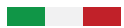

BACINELLE SOVRAPPONIBILI

BACINELLA SOVRAPPONIBILE MOD. 2/8

Stackable basin model 2/8 - Bac empilable mod 2/8

Stapelbare schüssel mod 2/8 - Bandeja honda apilable mod. 2/8

IN mm300x107 OUT mm325x132

Cod.	h mm	Capacity Lt	(Euro pcs)	master	Euro master
7BA28150	150	3,9	26,00	12	321,32
7BA28100	100	2,6	20,19	12	249,50
7BA28065	65	1,7	14,61	12	180,52
7BA28040	40	-	13,07	12	161,52
7BA28020	20	-	11,25	24	278,06



BACINELLA SOVRAPPONIBILE MOD. 1/6

Stackable basin model 1/6 - Bac empilable mod 1/6

Stapelbare schüssel mod 1/6 - Bandeja honda apilable mod. 1/6

IN mm153x140 OUT mm 176x162

Cod.	h mm	Capacity Lt	(Euro pcs)	master	Euro master
7BA16200	200	3,5	34,77	12	429,80
7BA16150	150	2,3	21,23	12	262,38
7BA16100	100	1,5	11,97	12	147,88
7BA16065	65	1,0	9,90	12	122,32
7BA16040	40	-	9,42	24	232,74
7BA16020	20	-	8,47	24	209,42



BACINELLA SOVRAPPONIBILE MOD. 1/9

Stackable basin model 1/9 - Bac empilable mod 1/9

Stapelbare schüssel mod 1/9 - Bandeja honda apilable mod. 1/9

IN mm 150x93 OUT mm 176x108

Cod.	h mm	Capacity Lt	(Euro pcs)	master	Euro master
7BA19100	100	0,8	15,15	24	374,52
7BA19065	65	0,6	9,56	24	236,42



BACINELLE FORATE SOVRAPPONIBILI

INOX
18/10

S O L O
VENDITA
MASTER
O N L Y
MASTER
SELLING



Perforated stackable basins

BACINELLA FORATA MOD. 2/1

Perforated stackable basin model 2/1 - Bac perforé empilable mod 2/1

Stapelbare Schüssel mit Löchern mod 2/1 - Bandeja honda perforada apilable mod. 2/1

IN mm 620x500 OUT mm 650x530

Cod.	h mm	Capacity Lt	master	Euro master
7BF21200	200	58,0	1	187,00
7BF21150	150	42,8	1	156,50
7BF21100	100	30,0	1	109,02
7BF21065	65	18,0	1	79,82
7BF21040	40	-	1	71,70
7BF21020	20	-	1	69,78



BACINELLA FORATA MOD. 1/1

Perforated stackable basin model 1/1 - Bac perforé empilable mod 1/1

Stapelbare Schüssel mit Löchern mod 1/1 - Bandeja honda perforada apilable mod. 1/1

IN mm 500x295 OUT mm 530x325

Cod.	h mm	Capacity Lt	(Euro pcs)	master	Euro master
7BF11200	200	27,8	96,13	6	594,08
7BF11150	150	20,0	80,68	6	498,58
7BF11100	100	13,7	52,68	6	325,54
7BF11065	65	8,8	32,22	6	199,12
7BF11040	40	-	29,52	12	364,90
7BF11020	20	-	26,79	12	331,06



BACINELLA FORATA MOD. 2/3

Perforated stackable basin model 2/3 - Bac perforé empilable mod 2/3

Stapelbare Schüssel mit Löchern mod 2/3 - Bandeja honda perforada apilable mod. 2/3

IN mm 330x300 OUT mm 355x325

Cod.	h mm	Capacity Lt	(Euro pcs)	master	Euro master
7BF23200	200	17,0	73,08	6	451,64
7BF23150	150	13,0	59,79	12	739,00
7BF23100	100	9,0	39,90	6	246,58
7BF23065	65	5,8	21,86	6	135,10
7BF23040	40	-	20,00	12	247,24
7BF23020	20	-	20,21	24	499,56



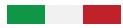

BACINELLA FORATA MOD. 1/2

Perforated stackable basin model 1/2 - Bac perforé empilable mod 1/2

Stapelbare Schüssel mit Löchern mod 1/2 - Bandeja honda perforada apilable mod. 1/2

IN mm 298x238 OUT mm 325x265

Cod.	h mm	Capacity Lt	(Euro pcs)	master	Euro master
7BF12200	200	12,0	58,62	12	724,50
7BF12150	150	9,2	48,65	12	601,32
7BF12100	100	6,1	30,94	12	382,42
7BF12065	65	4,0	19,95	12	246,58
7BF12040	40	-	18,19	12	224,82
7BF12020	20	-	16,43	24	406,10



BACINELLA FORATA MOD. 1/3

Perforated stackable basin model 1/3 - Bac perforé empilable mod 1/3

Stapelbare Schüssel mit Löchern mod 1/3 - Bandeja honda perforada apilable mod. 1/3

IN mm 300x150 OUT mm 325x175

Cod.	h mm	Capacity Lt	(Euro pcs)	master	Euro master
7BF13200	200	7,2	48,29	12	596,88
7BF13150	150	5,4	34,53	12	426,78
7BF13100	100	3,5	24,20	12	299,16
7BF13065	65	2,4	14,53	12	179,52



TEGLIE

Trays

INOX
18/10

SOLO
VENDITA
MASTER
ONLY
MASTER
SELLING



TEGLIA MOD. 2/1 BORDO PIANO

Tray 2/1 flat edge - Bac à four 2/1 bord plat

Fleischkasten 2/1 mit flachem Rand - Rustidera horno 2/1 bordo llana

IN mm 620x500 OUT mm 650x530

Cod.	h mm	Capacity Lt	master	Euro master
7TI21065	65	18,0	1	59,50
7TI21040	40	11,2	1	50,94
7TI21020	20	5,6	1	48,34



TEGLIA MOD. 1/1 BORDO PIANO

Tray 1/1 flat edge - Bac à four 1/1 bord plat

Fleischkasten 1/1 mit flachem Rand - Rustidera horno 1/1 bordo llana

IN mm 500x295 OUT mm 530x325

Cod.	h mm	Capacity Lt	(Euro pcs)	master	Euro master
7TI11065	65	8,8	24,87	6	153,70
7TI11040	40	5,3	22,51	12	278,16
7TI11020	20	2,6	21,05	12	260,12



TEGLIA MOD. 2/3 BORDO PIANO

Tray 2/3 flat edge - Bac à four 2/3 bord plat

Fleischkasten 2/3 mit flachem Rand - Rustidera horno 2/3 bordo llana

IN mm 300x300 OUT mm 355x325

Cod.	h mm	Capacity Lt	(Euro pcs)	master	Euro master
7TI23065	65	5,8	18,50	6	114,34
7TI23040	40	3,7	16,43	12	203,12
7TI23020	20	1,7	15,95	24	394,22



TEGLIA MOD. 1/2 BORDO PIANO

Tray 1/2 flat edge - Bac à four 1/2 bord plat

Fleischkasten 1/2 mit flachem Rand - Rustidera horno 1/2 bordo llana

IN mm 298x238 OUT mm 325x265

Cod.	h mm	Capacity Lt	(Euro pcs)	master	Euro master
7TI12065	65	4,0	15,36	12	189,80
7TI12040	40	2,4	13,24	12	163,64
7TI12020	20	1,2	12,12	24	299,48



COPERCHI

Lids

COPERCHIO NORMALE

Normal lid - Couvercle - Normaler Deckel - Tapa

Cod.	mod.	(Euro pcs)	master	Euro master
7CO11000	1/1	23,78	12	293,96
7CO23000	2/3	16,43	12	203,12
7CO12000	1/2	14,04	12	173,48
7CO13000	1/3	11,18	12	138,22
7CO14000	1/4	9,42	12	116,36
7CO24000	2/4	16,13	12	199,32
7CO28000	2/8	8,63	12	106,64
7CO16000	1/6	7,99	12	98,76
7CO19000	1/9	5,75	24	142,02



FALSO FONDO

False bottom

FALSO FONDO FORATO

False perforated bottom - Faux-fond perforé - Falscher Boden mit Löchern - Falso hondo perforado

Cod.	mod.	(Euro pcs)	master	Euro master
7FF11000	1/1	24,87	24	614,84
7FF23000	2/3	19,13	24	472,96
7FF12000	1/2	16,43	24	406,22
7FF21000	2/1	42,64	1	43,92



POLICARBONATO

Polycarbonate

INOX
18/10

S O L O
VENDITA
MASTER
O N L Y
MASTER
SELLING



BACINELLA SOVRAPPONIBILE MOD. 1/1

Stackable basin model 1/1 - Bac empilable mod 1/1

Stapelbare schüssel mod 1/1 - Bandeja honda apilable mod. 1/1

Cod.	h mm	(Euro pcs)	master	Euro master
7BP11200	200	30,33	6	187,44
7BP11150	150	24,54	6	151,68
7BP11100	100	19,80	6	122,36
7BP11065	65	17,42	6	107,66



BACINELLA SOVRAPPONIBILE MOD. 1/2

Stackable basin model 1/2 - Bac empilable mod 1/2

Stapelbare schüssel mod 1/2 - Bandeja honda apilable mod. 1/2

Cod.	h mm	(Euro pcs)	master	Euro master
7BP12200	200	16,09	12	198,92
7BP12150	150	14,04	12	173,48
7BP12100	100	11,01	12	136,08
7BP12065	65	9,18	12	113,50



BACINELLA SOVRAPPONIBILE MOD. 1/3

Stackable basin model 1/3 - Bac empilable mod 1/3

Stapelbare schüssel mod 1/3 - Bandeja honda apilable mod. 1/3

Cod.	h mm	(Euro pcs)	master	Euro master
7BP13200	200	13,73	12	169,66
7BP13150	150	11,18	12	138,16
7BP13100	100	8,79	12	108,66
7BP13065	65	8,18	12	101,12



POLICARBONATO

BACINELLA SOVRAPPONIBILE MOD. 1/4

Stackable basin model 1/4 - Bac empilable mod 1/4

Stapelbare schüssel mod 1/4 - Bandeja honda apilable mod. 1/4

Cod.	h mm	(Euro pcs)	master	Euro master
7BP14200	200	13,49	12	166,70
7BP14150	150	11,35	12	140,32
7BP14100	100	8,44	12	104,34
7BP14065	65	7,12	12	87,94



BACINELLA SOVRAPPONIBILE MOD. 1/6

Stackable basin model 1/6 - Bac empilable mod 1/6

Stapelbare schüssel mod 1/6 - Bandeja honda apilable mod. 1/6

Cod.	h mm	(Euro pcs)	master	Euro master
7BP16200	200	10,04	12	124,06
7BP16150	150	7,12	12	87,94
7BP16100	100	5,25	12	64,90
7BP16065	65	4,89	12	60,42



BACINELLA SOVRAPPONIBILE MOD. 1/9

Stackable basin model 1/9 - Bac empilable mod 1/9

Stapelbare schüssel mod 1/9 - Bandeja honda apilable mod. 1/9

Cod.	h mm	(Euro pcs)	master	Euro master
7BP19100	100	4,74	24	117,28
7BP19065	65	3,97	24	98,14



BACINELLA SOVRAPPONIBILE MOD. 2/1

Stackable basin model 2/1 - Bac empilable mod 2/1

Stapelbare schüssel mod 2/1 - Bandeja honda apilable mod. 2/1

Cod.	h mm	master	Euro master
7BP21200	200	1	64,54



COPERCHIO

Lid - Couvercle - Deckel - Tapa

Cod.	mod.	(Euro pcs)	master	Euro master
7CP21000	2/1	36,36	6	224,68
7CP11000	1/1	13,87	12	171,40
7CP12000	1/2	7,79	12	96,30
7CP13000	1/3	5,77	12	71,32
7CP14000	1/4	5,31	24	131,28
7CP16000	1/6	3,50	24	86,56
7CP19000	1/9	3,03	24	74,98



FALSO FONDO FORATO

False perforated bottom - Faux-fond perforé - Falscher Boden mit Löchern -

Falso hondo perforado

Cod.	mod.	(Euro pcs)	master	Euro master
7FP21000	2/1	24,85	12	307,12
7FP11000	1/1	8,63	24	213,22
7FP12000	1/2	5,25	24	129,66



POLIPROPILENE

Polypropylene

BACINELLA SOVRAPPONIBILE MOD. 1/1

Stackable basin model 1/1 - Bac empilable mod 1/1

Stapelbare schüssel mod 1/1 - Bandeja honda apilable mod. 1/1

Cod.	h mm	(Euro pcs)	master	Euro master
7PP11200	200	16,59	6	102,52
7PP11150	150	13,41	6	82,86
7PP11100	100	11,03	6	68,14
7PP11065	65	10,63	12	131,40



BACINELLA SOVRAPPONIBILE MOD. 1/2

Stackable basin model 1/2 - Bac empilable mod 1/2

Stapelbare schüssel mod 1/2 - Bandeja honda apilable mod. 1/2

Cod.	h mm	(Euro pcs)	master	Euro master
7PP12200	200	8,75	12	108,16
7PP12150	150	7,66	12	94,64
7PP12100	100	6,23	12	77,00
7PP12065	65	5,75	12	71,04



BACINELLA SOVRAPPONIBILE MOD. 1/3

Stackable basin model 1/3 - Bac empilable mod 1/3

Stapelbare schüssel mod 1/3 - Bandeja honda apilable mod. 1/3

Cod.	h mm	(Euro pcs)	master	Euro master
7PP13200	200	7,51	12	92,80
7PP13150	150	6,23	12	77,00
7PP13100	100	5,11	24	126,32
7PP13065	65	5,06	24	125,02



POLIPROPILENE

S O L O
VENDITA
MASTER
O N L Y
MASTER
SELLING

BACINELLA SOVRAPPONIBILE MOD. 1/4

Stackable basin model 1/4 - Bac empilable mod 1/4

Stapelbare schüssel mod 1/4 - Bandeja honda apilable mod. 1/4

Cod.	h mm	(Euro pcs)	master	Euro master
7PP14200	200	7,66	12	94,64
7PP14150	150	6,59	24	162,88
7PP14100	100	4,67	12	57,66
7PP14065	65	4,42	24	109,24



BACINELLA SOVRAPPONIBILE MOD. 1/6

Stackable basin model 1/6 - Bac empilable mod 1/6

Stapelbare schüssel mod 1/6 - Bandeja honda apilable mod. 1/6

Cod.	h mm	(Euro pcs)	master	Euro master
7PP16200	200	6,61	12	81,66
7PP16150	150	4,95	24	122,42
7PP16100	100	3,47	24	85,88
7PP16065	65	3,37	24	83,18



BACINELLA SOVRAPPONIBILE MOD. 1/9

Stackable basin model 1/9 - Bac empilable mod 1/9

Stapelbare schüssel mod 1/9 - Bandeja honda apilable mod. 1/9

Cod.	h mm	(Euro pcs)	master	Euro master
7PP19100	100	3,05	24	75,28
7PP19065	65	2,77	24	68,36



COPERCHIO

Lid - Couvercle - Deckel - Tapa

Cod.	mod.	(Euro pcs)	master	Euro master
7PP11000	1/1	6,24	12	77,12
7PP12000	1/2	3,68	24	90,84
7PP13000	1/3	3,52	24	87,00
7PP14000	1/4	2,76	24	68,14
7PP16000	1/6	2,21	24	54,64
7PP19000	1/9	1,99	48	98,52



MULTIPLI: LE COMBINAZIONI

Multiples: the combinations

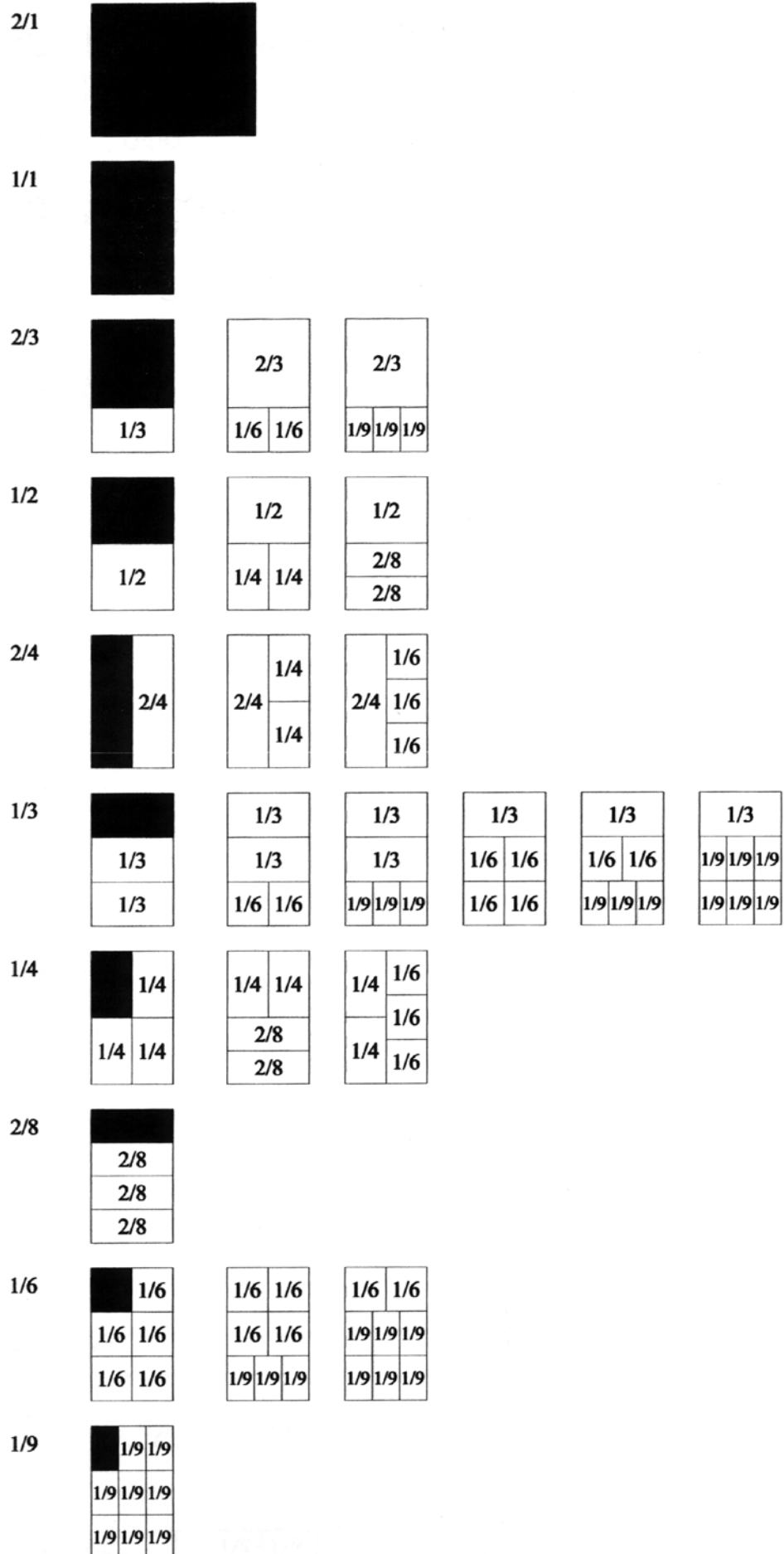

CARATTERISTICHE TECNICHE

Technical informations

ACCIAIO E SPESSORI la serie Gastronorm è prodotta con acciaio AISI 304, chiamato anche 18/10, negli spessori:

-1 mm per i modelli 2/1

-da 0.6 a 0.8 per le altre pezzature restanti

LUCIDATURA le altezze 100, 150, 200 sono sottoposte ad una operazione di normalizzazione termica e poi lucidate mediante burattatura. Oggetti di grandi dimensioni sono puliti per via elettrolitica. Le altezze 65, 40 e 20 vengono prodotte con acciaio BA e sottoposte a trattamento chimico che permette di ottenere una lucidatura omogenea su tutta la superficie.

CONFEZIONE ogni singolo pezzo è sottoposto a lavaggio speculare ad alta temperatura 90° e confezionato in polipropilene pronto per l'uso già sterilizzato.

CAPACITÀ i raggi ridotti al minimo offrono il massimo della capienza nel minimo ingombro.

MATERIALI sono tutti certificati ed idonei al contatto con gli alimenti ai sensi dell' DM. 25-1-1992 art. 4-5° comma D.L. 208 e DIR. CEE 89/109.

LAVAGGIO resistenti all'uso prolungato in lavastoviglie.

MISURE in accordo con gli standard internazionali della CEE doc. CEN/TC 194 EN631-1.

THE STEEL AND THE THICKNESSES the Gastronorm range is made of AISI 304 steel also called 18/10, in the following thicknesses:

-1 mm for the 2/1 models

-from 0.6 to 0.8 for the remaining sizes

POLISHING heights 100, 150 and 200 are thermally normalised and then polished by tumbling. Large items are etch cleaned. Heights 65, 40 and 20 are made of BA steel and are subjected to a chemical treatment permitting the attainment of even polishing over the entire surface.

PACKAGING each individual piece is bright washed at the high temperature of 90° and packaged in polypropylene, ready for use already sterilised.

CAPACITY The finely rounded bottom edges offer maximum capacity in the minimum space.

MATERIALS all the materials are certified to be suitable for contact with foodstuffs according to DM. 25-1-1992 art. 4 - 5th para. D.L. 208 and EEC Directive 89/109.

WASHING resistant to prolonged dish-washing.

SIZES in accordance with the international EEC standards doc. CEN/TC 194 EN631-1.





P R E P A R A Z I O N E

P r e p a r a t i o n

L a P r é p a r a t i o n

V o r b e r e i t u n g

P r e p a r a c i ó n



Per alimenti
Suitable for foodstuffs
Apte au contact avec les aliments
Für Lebensmittel
Apto para alimentos



Garantito per lavastoviglie
Dishwasher safe
Inalterable dans lave-vaisselle
Spelmaschinenfest
Apto para lavavajillas

BAGNOMARIA

Bain-marie

BAGNOMARIA CILINDRICO CON MANICO

Cylindrical bain-marie with handle - Bain-marie cylindrique avec manche

Bain-marie zylindrisch mit Stiel - Baño maria cilindrico con mango

Cod. 509031..

Ø cm	h cm	Lt	Euro
14	16	2¼	33,22
16	18	3½	36,94
18	20	5	40,64
20	22	7	49,50



BAGNOMARIA QUADRATO

Square bain-marie - Bain-marie carré - Bain-marie viereckig - Baño maria cuadrado

Cod.	cm	h cm	Lt	Euro
50903003	16	16	3½	58,48
50903005	16	25	5	77,36



COPERCHIO BAGNOMARIA QUADRATO

Square lid - Couvercle carré - Deckel viereckig - Tapa cuadrada

Cod. 50903316

cm	h cm	Euro
16	16	17,60



COLAPASTA

INOX
18/10

Colander

COLAPASTA SFERICO CON BASE

Spherical colander with foot - Passoire sphérique avec base

Küchensieb mit Fuß - Escurridor esférico con base

Cod. 509008..

Ø cm	h cm	Euro
34	20	140,22
40	22	174,66



COLAPASTA

Colander - Passoire - Küchensieb-Escurridera

Cod. 301062..

Ø cm	Euro
22	41,98
24	44,92
26	52,10
28	59,50



COLAPASTA SFERICO CON 1 MANICO E GANCIO

Spherical colander 1 handle and hook - Passoire sphérique 1 manche et crochet

Brühesieb mit Stiel und Haken - Escurridor 1 mango con gancho

Cod. 509007..

Ø cm	h cm	Euro
22	10,5	36,72
24	11,5	38,46
26	13	49,30
28	14	50,36



SCALDAPASTA FORATO CON 1 MANICO E GANCIO

Colander 1 handle and hook - Passoire 1 manche et crochet
Seiher mit Stiel und Haken - Colador 1 mango con gancho
Cod. 509009..

Ø cm	h cm	Euro
18	10,0	37,06
20	11,5	43,46
22	12,5	48,56
24	13,5	60,14



CONO CINESE

Chinois - Chinois - Spitzsieb - Colador chino

Cod.	Ø cm	Euro
78500350	13	12,30
78500351	17	18,40
78500352	19	20,52
78500353	20	23,74
78500354	22	30,72
78500355	24	32,26
78500356	26	36,70



PASSABRODO

Strainer - Passoire pour bouillon - Suppen-filtersieb - Pasacaldo

Cod.	Ø cm	h cm	Euro
71000106	6,3	1,8	3,58
71000114	13	5,5	9,38
71000116	16,5	6,5	13,84
71000118	18,5	8,0	17,20



SCALDAPASTA A SETTORI

Section colander - Passoire à secteurs - Einsatz - Sección para colador
Cod. 509012..

size	Ø cm	h cm	Euro
1/3	34	20,5	48,02
1/4	40	26,5	52,04



SETACCI

INOX
18/10

Strainers

Finitura esterna ed interna lucida
Outside and inside satin finish

SETACCIO FARINA

Flour strainer - Passoire à farine

Mehlsieb - Cedazo harina

Cod. 509055..

mm	Ø cm	Euro
	21	16,30
2,5x1,4	30	22,50
	35	25,60

mm
2,5x1,4

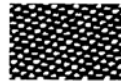

SETACCIO VELO

Strainer - Passoire

Mehlsieb - Cedazo

Cod. 509056..

mm	Ø cm	Euro
	21	17,30
1,5x1	30	22,50
	35	25,60

mm
1,5x1



SETACCIO PANE

Bread strainer - Passoire à pain

Mehlsieb - Cedazo pan

Cod. 509057..

mm	Ø cm	Euro
	30	22,50
4x3	35	25,60

mm
4x3



SETACCIO PESCE

Fish strainer - Passoire à poisson

Mehlsieb - Cedazo pescado

Cod. 509058..

mm	Ø cm	Euro
	30	24,62
11x9	35	28,20

mm
11x9



ACCESSORI

Accessories

INSALATIERA BASE PIANA SENZA MANIGLIE

Salad bowl w/handles - Saladier sans poignées - Salatschüssel ohne Griffe - Ensaladera sin asas
Cod. 509038..

Ø cm	h cm	Lt	Euro
16	7	1	13,10
18	8	1½	19,16
22	10	2½	23,72
24	11	3½	26,94
26	12	4½	33,56
28	13	5½	37,98
34	16	12¾	73,68
40	19	16	103,36



INSALATIERA CONICA BORDATA

Conical salad bowl - Saladier conique - Konische Salatschüssel - Ensaladera conica
Cod. 509037..

Ø cm	h cm	Lt	Euro
16	6	1/2	8,16
18	6,8	3/4	10,48
20	7,2	1	12,68
22	7,6	1⅓	15,14
24	9	1¾	17,64
28	10	2¾	22,50
32	11	4¾	30,88
36	13,2	6¾	38,96
40	13,7	8⅓	44,24



BASTARDELLA BASE PIANA CON MANIGLIE

Salad bowl with handles - Saladier sans poignées - Salatschüssel ohne Griffe - Ensaladera sin asas
Cod. 509036..

Ø cm	h cm	Lt	Euro
16	7	1	21,44
18	8	1½	24,66
22	10	2½	31,40
24	11	3½	34,86
26	12	4½	41,66
28	13	5½	47,20
34	16	12¾	86,90
40	19	16	116,02





BASTARDELLA SEMISFERICA CON MANIGLIE

Semispheric-mixing bowl with handles - Saladier hémisphérique avec poignées - Schlagschüssel mit Griffen - Caldero semiesférico con asas
Cod. 509039..

Ø cm	h cm	Lt	Euro
22	12	3	30,74
28	15	6	45,68
34	20	12	91,12
40	22	17	116,66



BASE PER BASTARDELLA SEMISFERICA

Foot for semispheric-mixing bowl - Base pour saladier hémisphérique
Halterung für Schlagschüssel - Base para caldero semiesférico
Cod. 509040..

Ø cm	Euro
22/28	11,46
34/40	20,34



PASSAVERDURA PROFESSIONALE

Professional vegetable mill - Moulin à légumes professionnel - Profipassiergerät
- Pasa-puré profesional
Cod. 509052..

Ø cm	h cm	Euro
32	19	292,00
42	19	303,88



DISCHI RICAMBIO

Spare discs - Disques de rechange
Zusatzscheiben kleine - Discos repuesto
Cod. 97150017 **Euro 21,28**
Cod. 97150018 **Euro 21,28**

MANOVELLA

Crank - Manivelle - Kurbel - Manivela
Cod. I6905006 **Euro 71,20**
Cod. I6905007 **Euro 74,66**

FORMA CRÈME-CARAMEL

Crème caramel mould - Moule pour crème-caramel - Form für crème caramel -
 Molde para flan de caramelo

Cod. 50953107

Ø cm	h cm	Lt	Euro
7	7	0,27	7,86



MATTARELLO

Rolling - Rouleau à pâtisserie - Wellholz - Rodillo de pastelería

Cod. 50908148

lunghezza cm	Euro
48	43,32



IMBUTO

Funnel - Entonnoir - Trichter - Embudo

Cod. 50907816

Ø cm	Euro
16	20,48



IMBUTO

Funnel - Entonnoir - Trichter - Embudo

Cod. 50907820

Ø cm	Euro
20	23,84





P R E S E N T A Z I O N E

P r e s e n t a t i o n

P r é s e n t a t i o n

P r ä s e n t a t i o n

P r e s e n t a c i ó n



Per alimenti
Suitable for foodstuffs
Apte au contact avec les aliments
Für Lebensmittel
Apto para alimentos



Garantito per lavastoviglie
Dishwasher safe
Inalterable dans lave-vaisselle
Spelmaschinenfest
Apto para lavavajillas

VASSOI

Trays

PIATTO OVALE PORTATA BORDATO PESANTE

Edged oval tray - Plateau oval avec bord - Ovale Bratenplatte - Fuente ovalada rebordeada
Cod. 509316..

cm	spess. mm	master	Euro
26x19	0,7	10	17,74
31x21	0,7	10	18,62
36x25	0,7	10	21,86
42x29	0,7	10	25,66
47x34	0,8	10	31,50
53x35	0,8	10	45,12
60x39	0,8	-	54,20
70x46	1,2	-	146,86
85x58	1,2	-	389,78



Cod. 50931699

cm	spess. mm	master	Euro
100x68	1,2	-	474,62

PIATTO OVALE PORTATA BORDATO

Edged oval tray - Plateau oval avec bord - Serviertablett - Fuente ovalada rebordeada
Cod. 509333..

cm	spess. mm	master	Euro
19x15	0,6	10	13,96
23x16	0,6	10	15,16
26x20	0,6	10	16,24
29x22	0,6	10	16,66



PIATTO OVALE PORTATA NORMALE

Oval tray - Plateau oval - Einfache ovale Platte - Fuente ovalada
Cod. 509314..

cm	spess. mm	master	Euro
32x22	0,7	10	18,82
40x29	0,7	10	24,30
48x32	0,7	10	32,16



PIATTO OVALE GASTRONOMICO

Oval tray - Plateau oval - Tiefe ovale Platte - Fuente ovalada

Cod. 50931942

cm	spess. mm	master	Euro
42x31	0,7	10	37,24



PIATTO OVALE PORTATA PESCE

Fish tray - Plat oval à poisson - Fischplatte - Fuente ovalada pescado

Cod. 509336..

cm	spess. mm	master	Euro
55x24	1,0	-	43,08
70x29	1,0	-	58,84
85x33	1,2	-	120,44

Cod. 50933699

cm	Spess. mm	master	Euro
100x34	1,2	-	158,22



VASSOIO TONDO BORDATO

Round edged tray - Plateau rond bordé - Rundes Tablett - Bandeja redonda rebordeada

Cod. 509330..

Ø cm	spess. mm	master	Euro
30	0,7	10	23,60
35	0,8	10	30,40



VASSOIO GRATIN

Serving tray gratin - Plat à gratin - Gratinplatte - Bandeja gratin

Cod. 509368..

cm	spess. mm	master	Euro
40x21	1,0	-	36,28
45x23	1,0	-	43,28
50x27	1,0	-	50,



VASSOIO RETTANGOLARE

Rectangular tray - Plateau rectangulaire - Tablett - Bandeja rectangular
Cod. 509312..

cm	spess. mm	master	Euro
25x20	1,0	10	20,56
32x25	1,0	10	27,72
36x29	1,0	10	31,04
40x33	1,0	10	34,22
45x35	1,0	-	42,54
48x37	1,0	-	45,56
60x47	1,0	-	70,90



VASSOIO RETTANGOLARE CON MANIGLIE

Rectangular tray with two handles - Plateau rectangulaire à deux manches
Tablett mit zwei Griffen - Bandeja rectangular con asas
Cod. 509313..

cm	spess. mm	master	Euro
48x37	1,0	-	70,56
60x47	1,0	-	97,50



VASSOIO RETTANGOLARE MAGNA CON MANIGLIE

Magna rectangular tray with two handles - Plateau rectangulaire Magna à deux manches -
Magna Tablett mit zwei Griffen - Bandeja rectangular con dos asas s
Cod. 509313..

cm - h cm	spess. mm	master	Euro
44x29x3	1,0	-	58,22
50x33x3	1,0	-	66,34



VASSOIO TONDO BORDATO

Round edged tray - Plateau rond bordé - Rundes Tablett - Bandeja redonda rebordeada
Cod. 509329..

Ø cm	Ø cm IN	spess. mm	master	Euro
34	28,0	0,7	10	31,04
38	32,2	0,7	10	35,16
42	34,4	0,8	10	44,04
46	39,5	0,8	-	52,48
53	45,5	0,8	-	67,64



VASSOIO TONDO BORDATO CON MANIGLIE

Round edged tray with handles - Plateau rond bordé avec poignées
Rundes Tablett mit Griffen - Bandeja redonda rebordeada con asas
Cod. 509327..

Ø cm	spess. mm	master	Euro
42	0,8	-	112,68
46	0,8	-	121,44
53	0,8	-	137,70





TENDER VASSOI 5382

Inox

Made in Italy 

composizione materiale %

Cr	16/18
C	< 0,08
Mn	< 1,0
P	< 0,04
S	< 0,015
Si	< 1,0

-Produzione totalmente italiana.

-Tutti i materiali impiegati sono della migliore qualità e idonei al contatto alimentare ai sensi del DM 25/01/1992 art. 4, 5° comma e della DIR. CEE 89/109.

-Ogni articolo confezionato in busta trasparente.

-All the series are Made in Italy.

-All the material used in mass production are suitable for food contacts as for the law DM 25/01/1992 art. 4, 5° comma and DIR. CEE 89/109.

-Every piece is in a transparent polybag.

MATERIALE:

AISI 430 CERTIFICATO

(UNI EN 10088)

IDONEO AL CONTATTO ALIMENTARE

(DM 21/03/1973)

VASSOIO OVALE PORTATA BORDATO TENDER

Edged oval tray - Plateau oval avec bord - Ovale Bratenplatte - Fuente ovalada rebordeada
Cod. 538219..

cm	spess. mm	master	Euro pcs
26x19	0,6	10	8,14
31x21	0,7	10	9,40
36x25	0,7	10	11,06
42x29	0,7	10	12,66
47x31	0,8	10	16,78
53x35	0,8	10	19,16



VASSOIO TONDO CAMERIERE TENDER

Round tray - Plateau rond - Rundes Tablett - Bandeja redonda
Cod. 538259..

Ø cm	h cm	master	Euro pcs
24	1,85	10	8,38
28	1,76	10	10,72
32	1,93	10	12,42
36	1,95	10	14,12



VASSOIO RETTANGOLARE TENDER

 Rectangular tray - Plateau rectangulaire - Tablett - Bandeja rectangular
 Cod. 538272..

cm	spess. mm	master	Euro pcs
25x20	0,6	10	11,06
32x25	0,6	10	13,22
36x29	0,7	10	14,50
40x31	0,7	10	16,56
45x35	0,8	-	19,06
48x37	1,0	-	22,50
60x47	1,0	-	30,40

VASSOIO BAR TENDER

Rectangular tray - Plateau rectangulaire - Tablett - Bandeja rectangular

Cod.	cm	h cm	Euro
53827825	25x20	0,8	19,34
53827835	35x10	0,8	16,90
53827836	35x20	0,8	22,08
53827840	40x10	0,8	17,16
53827842	40x20	0,8	22,88
53827850	50x10	0,8	20,36
53827852	50x20	0,8	28,80
53827860	60x10	0,8	25,26
53827862	60x20	0,8	30,44
53827870	70x20	0,8	38,88





ZUPPIERA

Sauce bowl

ZUPPIERA

Soup bowl - Soupière - Suppenterrine - Sopera

Cod. 308772..

Ø cm	h cm	Lt	Euro
18	10	1,5	33,34
22	12	3	40,22
24	13	4	42,96
26	14	4,75	50,06
28	15	6	58,48



COPERCHIO PER ZUPPIERA

Lid for soup bowl - Couvercle pour soupière - Deckel für Suppenterrine - Tapa para sopera

Cod. 308775..

Ø cm	Euro
18	19,58
22	22,42
24	24,04
26	28,40
28	30,18



SALSIERE

Sauce boat

SALSIERA CON BASE

Sauce boat with foot - Saucière sur pied - Sauciere mit Fuß - Salsera con base

Cod. 509153..

cl	master	Euro
9	10	9,12
14	10	10,56
22	10	11,24
28	10	15,74
45	10	22,28



SALSIERA SENZA BASE

Sauce boat without foot - Saucière sans pied - Sauciere ohne Fuß - Salsera sin base

Cod. 50915420

cl	master	Euro
20	10	11,48



CLOCHE

Cloche

CLOCHE SEMISFERICA CON POMOLO

Semispheric cloche with knob - Cloche hémisphérique avec pommeau
Speiseglocke kugelförmig mit Griff - Cloche semiesferica con pomo
Cod. 509322..

Ø cm IN	h cm	for round tray Ø cm	Euro
22	12	30	32,16
24	13	30	34,16
26	14	35	40,30
28	15	35	47,78



CLOCHE ROTONDA CON POMOLO

Round cloche with knob - Cloche ronde avec pommeau
Speiseglocke mit Griff - Cloche redonda con pomo
Cod. 509323..

Ø cm IN	for round tray Ø cm	Euro
25	30	38,44
30	35	51,28



CLOCHE OVALE CON POMOLO

Oval cloche with knob - Cloche ovale avec pommeau
Speiseglocke oval mit Griff - Cloche ovalada con pomo
Cod. 509321..

cm IN	for oval tray cm	Euro
32	36	48,42
42	47	64,02



PORTA BURRO

Butter dish

PORTA BURRO DA TAVOLA

Butter dish - Porte beurre - Butterschale - Mantequillera
50933111

Ø cm	h cm	Euro
12,5	8,7	23,42



ACCESSORI STONE WASHED

Stone Washed accessories

COPERCHIO PER ZUPPIERA

Lid for soup bowl - Couvercle pour soupière - Deckel für Suppenterrine - Tapa para sopera
Cod. 539906..

Ø cm	Euro
18	47,54
22	54,52
24	61,08
26	69,84
28	79,68



ZUPPIERA

Soup bowl - Soupière - Suppenterrine - Sopera
Cod. 539905..

Ø cm	h cm	Lt	Euro
18	10	1,5	67,66
22	12	3	82,94
24	13	4	96,06
26	14	4,75	112,12
28	15	6	120,10

CLOCHE SEMISFERICA CON POMOLO

Semispheric cloche with knob - Cloche hémispherique avec pommeau
Speiseglocke kugelförmig mit Griff - Cloche semiesferica con pomo
Cod. 539992..

Ø cm IN	h cm	for round tray Ø cm	Euro
22	12	30	63,92
24	13	30	70,92
26	14	35	82,38
28	15	35	90,92



SALSIERA CON BASE

Sauce boat with foot - Saucière sur pied - Sauciere mit Fuß - Salsera con base
Cod. 53998014

cl	Euro
14	21,96







U T E N S I L I

T o o l s

U s t e n s i l e s

Z u b e h ö r

U t e n s i l i o s



Per alimenti
Suitable for foodstuffs
Apte au contact avec les aliments
Für Lebensmittel
Apto para alimentos



Garantito per lavastoviglie
Dishwasher safe
Inalterable dans lave-vaisselle
Spuelmaschinenfest
Apto para lavavajillas

MESTOLAME UNIPEZZO PESANTE

One-piece ladle

MESTOLO UNIPEZZO

One-piece ladle - Louche monobloc

Suppenshöpfer einteilig - Cazo una piez

Cod. 509258..

Ø cm	lungh. cm	Euro
6	28	7,76
8	34	8,90
9	37	12,28
10	37	12,52
11	37	13,10
12	38	17,26
14	57	21,08
16	61,5	33,46



MESTOLO UNIPEZZO FORATO

Slotted one piece ladle - Louche monobloc avec trous

Löcher Suppenshöpfer einteilig - Cazo una pieza agujerz

Cod. 509226..

Ø cm	lungh. cm	Euro
6	28	8,12
8	34	8,70
10	37	12,52
12	38	18,18
16	61,5	30,34

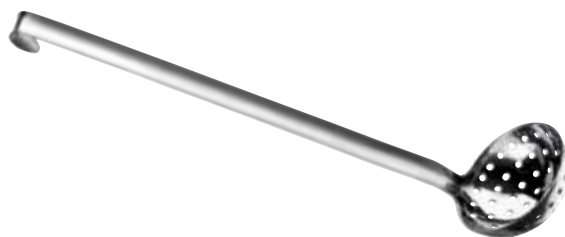

SCHIUMAROLA UNIPEZZO

One-piece skimmer - Ecumoire monobloc

Schaumlöffel einteilig - Espumadera una piezz

Cod. 509269..

Ø cm	lungh. cm	Euro
11	37	11,10
12	38	11,92
14	42	16,44
16	57,5	22,44
18	61	27,44



MESTOLO UNIPEZZO SALSA

One piece sauce ladle - Sauce louche monobloc

Sauce Löcher Suppenschopfer - Cazo una pieza por salsa

Cod. 50926300

cm	Euro
27	5,42



SPATOLA UNIPEZZO

One piece spatula - Spatule

Spachtel - Espátula

Cod.	cm	Euro
50923910	46	15,18
50923912	55	18,86



PALA FRITTO UNIPEZZO NUOVA FORATURA

One piece spatula - Pelle monobloc

Bratenwender einteilig - Pala fritos una pieza

Cod.	cm	Euro
50923010	46	14,58
50923012	55	19,22



FORCHETTONE UNIPEZZO

One-piece serving fork - Fourchette à servir monobloc

Fleischgabel einteilig - Tenedor una pieza

Cod. 50926600

cm	Euro
50	25,92



FORCHETTONE UNIPEZZO PESANTE 3 PUNTE

One-piece 3 prongs serving fork - Fourchette à servir monobloc 3 dents

Fleischgabel einteilig mit 3 zinken - Tenedor una pieza con 3 púas

Cod. 509267..

cm	Euro
50	28,12
70	33,92



NUOVO CUCCHIAIONE FONDO UNIPEZZO

One piece deep serving spoon - Profond cuiller à servir monobloc

Bratenloffel tief einteilig - Cucharon una pieza profundo

Cod. 50926700

cm	Euro
46	13,80



PALA FRITTO UNIPEZZO

One-piece spatula - Pelle monobloc

Bratenwender einteilig - Pala fritos una pieza

Cod. 50927700

cm	Euro
36	9,86



CUCCHIAIONE UNIPEZZO

One-piece serving spoon - Cuiller à servir monobloc

Bratenlöffel einteilig - Cucharon una pieza

Cod. 50926200

cm	Euro
35	9,04



FORCHETTONE UNIPEZZO

One-piece serving fork - Fourchette à servir monobloc

Fleischgabel einteilig - Tenedor una pieza

Cod. 50926500

cm	Euro
35	7,98



SCHIUMAROLE

Skimmers

SCHIUMAROLE A FILO

Wire skimmer - Ecumoire araignée - Schaumlöffel mit draht - Espumadera de alambre

Cod.	Ø cm	Euro
52584214	14	15,40
52584216	16	16,32
52584218	18	16,80
52584220	20	17,80
52584224	24	20,18
52584228	28	21,12

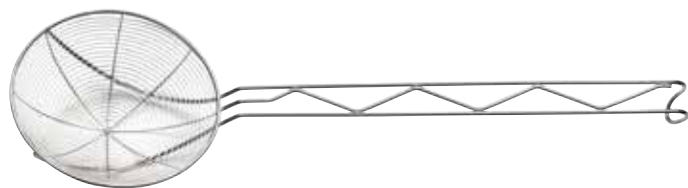

SCHIUMAROLE A RETE

Mesh skimmer - Ecumoire passoire - Schaumlöffel mit netz - Espumadera de red

Cod.	Ø cm	Euro
52584114	14	15,40
52584116	16	16,32
52584118	18	16,80
52584120	20	17,80
52584124	24	20,18
52584128	28	21,12

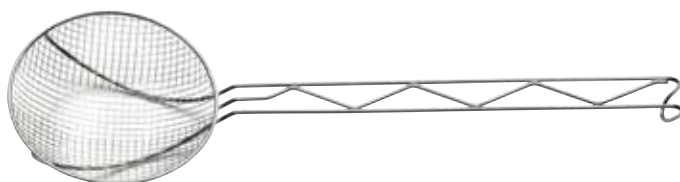

FRUSTE

Wisk

FRUSTA (8 fili)

Whisk - Fouet

Schneebeesen - Batidor

Cod. 509164..

cm	Euro
25	6,60
30	7,16
35	7,72
40	8,50
45	11,52
50	11,84
55	15,72
60	16,92





UTENSILI DA CUCINA

Kitchen tools

BATTICARNE PROFESSIONALE MANICO ACCIAIO

Meat mallet with steel handle - Battoir à viande avec manche en acier

Fleischklopfen - Picador de carne con mango de acero

Cod.	gr	Euro
50907306	600	23,16
50907315	1500	50,74



ROMPINOCI 2 NICCHIE

Nutcracker - Casse-noix - Nussknacker - Cascanueces

Cod. 50916001

master	Euro
40	10,66



TRINCIAPOLLO CON MOLLA INTERNA

Poultry shears (internal spring) - Coupe-volailles (ressort intérieur)

Geflügelschere (Interne Feder) - Tijeras para aves

Cod. 50907400

cm	master	Euro
25	30	22,62



RACCOGLI BRICIOLE

Crumb collector - Ramasse-miettes - Tischkrümelsammler - Recoge migas

Cod. 50916600

master	Euro
240	1,96



UTENSILI DA CUCINA

APPENDI ORDINI IN ALLUMINIO

Order rack - barre porte commandes

Halter für Bestellbelege - Barra de aluminio porta nota

Cod. 78500325

cm	Euro
91	25,08



MOLLE PROFESSIONAL

Professional tongs

MOLLA ARROSTO PROFESSIONAL

Roast meat tong - Pince à rôti

Bratenzange - Pinza para asado

Cod. 50919701

lungh. cm	master	Euro
26	12	14,72



MOLLA SPAGHETTI PROFESSIONAL

Spaghetti tong - Pince à spaghetti

Spaghettizange - Pinza para espaguetis

Cod. 50919601

lungh. cm	master	Euro
26	12	15,76



MOLLA GASTRONORM PROFESSIONAL

Gastronorm tong - Pince gastronorm

Gastronormzange - Pinza gastronorm

Cod. 50919901

lungh. cm	master	Euro
26	12	17,20



MOLLA PANE PROFESSIONAL

Bread tong - Pince à pain
Brotzange - Pinza para pan
Cod. 50919501

lungh. cm	master	Euro
26	12	15,24



MOLLA INSALATA PROFESSIONAL

Salad tong - Pince à salade
Salatzange - Pinza para ensalada
Cod. 50919001

lungh. cm	master	Euro
26	12	15,76



PINZA DEL CUOCO

Chef tong - Pince de chef
Chefzange - Pinza del cocinero
Cod. 588183..

lungh. cm	master	Euro
30	12	4,70
35	12	5,20
40	12	5,60



MOLLE BUFFET

Buffet tongs

MOLLA SERVIZIO BUFFET
serving tongs
Cod. 58137224

lungh. cm	master	Euro
24	12	5,36



MOLLA ARROSTO BUFFET
roast meat tongs
Cod. 58136024

lungh. cm	master	Euro
24	12	5,36



MOLLA UNIVERSALE BUFFET
all purpose tongs
Cod. 58137324

lungh. cm	master	Euro
24	12	5,36



MOLLA PANE BUFFET
bread tongs
Cod. 58136824

lungh. cm	master	Euro
24	12	5,36



MOLLA INSALATA BUFFET
salad tongs
Cod. 58136620

lungh. cm	master	Euro
20	12	5,04



MOLLA MULTIUSO BUFFET
multi purpose tongs
Cod. 58137524

lungh. cm	master	Euro
24	12	5,36



MOLLA DOLCE BUFFET
cake tongs
Cod. 58136124

lungh. cm	master	Euro
24	12	5,36



MOLLA SPAGHETTI BUFFET
spaghetti tongs
Cod. 58136924

lungh. cm	master	Euro
24	12	5,36



MOLLA VERDURE BUFFET
vegetables tongs
Cod. 58137424

lungh. cm	master	Euro
24	12	5,36



MOLLE EASY LINE

Easy line tongs



MOLLA DOLCE

Cake tongs - Pince à gâteau
Gebäckzange - Pinza para pastel
Cod. 50919400

lungh. cm	master	Euro
20	120	2,88



MOLLA PANE

Bread tongs - Pince à pain
Brotzange - Pinza para pan
Cod. 50919500

lungh. cm	master	Euro
22	120	3,08



MOLLA SPAGHETTI

Spaghetti tongs - Pince à spaghetti
Spaghetti-Zange - Pinza para espaguetis
Cod. 50919600

lungh. cm	master	Euro
20	120	2,88



MOLLA ARROSTO

Roast tongs - Pince à rôti
Bratenzange - Pinza para asado
Cod. 50919700

lungh. cm	master	Euro
21	120	2,88



MOLLA LUMACHE

Snails tongs - Pince à escargots

Schneckenzange - Pinza para caracoles

Cod. 50919800

lungh. cm	master	Euro
16	24	4,64



MOLLA ZUCCHERO INOX

Sugar tongs - Pince à sucre

Zuckerzange - Pinza para azucar

Cod. 50919100

lungh. cm	master	Euro
11	200	1,24



MOLLA GHIACCIO ELITE

Ice tongs Elite - Pince à glace Elite

Eiszange Elite - Pinza para hielo

Cod. 50918900

lungh. cm	master	Euro
15	24	4,04



MOLLA GHIACCIO DENTATA INOX 18/10

Ice tongs inox 18/10 - Pince à glace inox 18/10

Eiszange mit Zähnen inox 18/10 - Pinza para hielo inox 18/10

Cod. 50919300

lungh. cm	master	Euro
16	80	7,52



MOLLA GHIACCIO

Ice tongs - Pince à glace
Eiszange - Pinza para hielo
Cod. 50919200

lungh. cm	master	Euro
13	200	2,26



PINZA AFFETTATI

Sliced meat tongs - Pince à charcuterie
Aufschnittzange - Pinza para embutidos
Cod. 50907100

lungh. cm	master	Euro
10	100	7,18



PINZA CUOCO PUNTE PIEGATE

German tong bend - pince de chef
Chefzange - Pinza cocinero

Cod.	cm	Euro
78500440	35	8,12
78500441	45	10,18



Cake tongs

FORBICE DOLCE

Cake tongs - Pince à gâteau

Gebäckschere - Pinza para pastel

Cod. 50918000

lungh. cm	master	Euro
20	120	5,72



FORBICE DOLCE BUFFET

Cake tongs - Pince à gâteau

Gebäckschere - Pinza para pastel

Cod. 581307..

lungh. cm	master	Euro
16	12	9,30
20	12	10,80



VENDITA A
MASTER
6 PZ

MASTER
SELLING
6 PCS

KITCHEN TOOLS

-Articoli professionali

-GERMAN STEEL

-Serie complete

-Manici sovrastampati, non si staccano

-Manici soft-touch con grip antiscivolo

-Professional tools

-GERMAN STEEL

-Complete series

-Over-moulded handles, they do not detach

-Soft-touch handles with no-slip grip

SPATOLE - Spatulas

SPALMABURRO

Spreader, plain - Couteau à beurre - Butterspachtel - Pala de untar

Cod. 78300000

Euro 7,08



SPALMABURRO SEGHETTATO

Spreader, serrated - Couteau à beurre dentelé - Butterspachtel gezahnt - Pala de untar dentada

Cod. 78300006

Euro 7,08

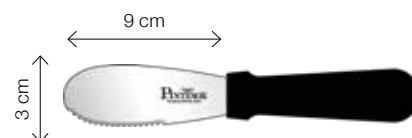

PALA TORTA

Pie server - Pelle à tarte - Tortenheber - Pala para tarta

Cod. 78300011

Euro 6,86

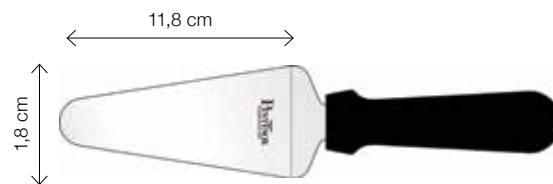

PALA TORTA

Pie server - Pelle à tarte - Tortenheber - Pala para tarta

Cod. 78300012

Euro 7,74

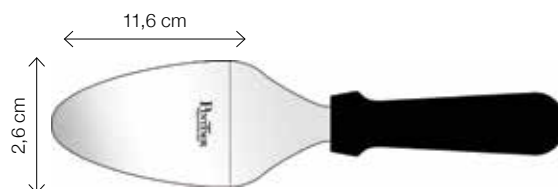

SPATOLA cm 6,2x5,9

Turner - Spatul - Spatel - Espátula

Cod. 78300016

Euro 7,08



SPATOLA cm 10x6,4

Turner - Spatul - Spatel - Espátula

Cod. 78300017

Euro 7,30

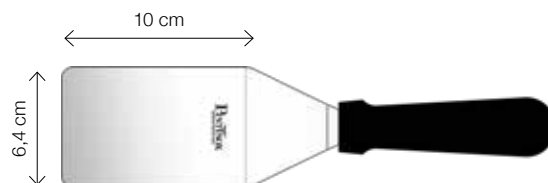

SPATOLA cm 11x8

Turner - Spatul - Spatel - Espátula

Cod. 78300018

Euro 9,74

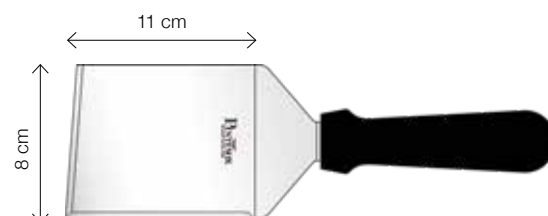

KITCHEN TOOLS

VENDITA A
MASTER
6 PZ
MASTER
SELLING
6 PCS

SPATOLA cm 10x7,6
Turner - Spatul - Spatel - Espátula
Cod. 78300019
Euro 12,16

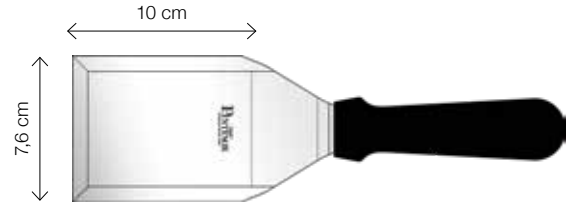

SPATOLA cm 14,5x10,8
Turner - Spatul - Spatel - Espátula
Cod. 78300020
Euro 13,26

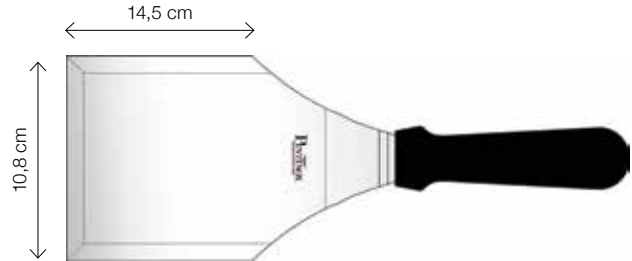

SPATOLA cm 15,3x13
Turner - Spatul - Spatel - Espátula
Cod. 78300021
Euro 18,12

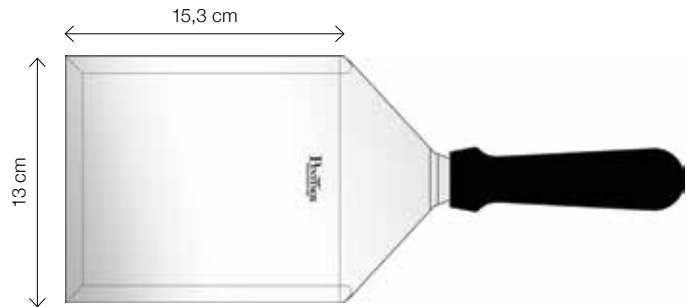

SPATOLA cm 15,6x7,6
Turner - Spatul - Spatel - Espátula
Cod. 78300022
Euro 11,06

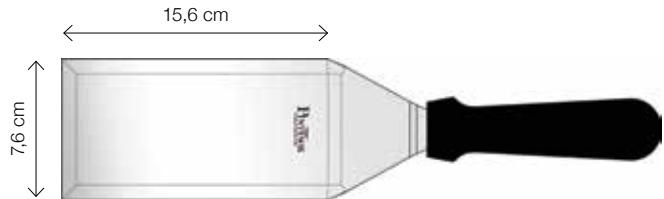

SPATOLA cm 14,6x9,6
Turner - Spatul - Spatel - Espátula
Cod. 78300023
Euro 14,94

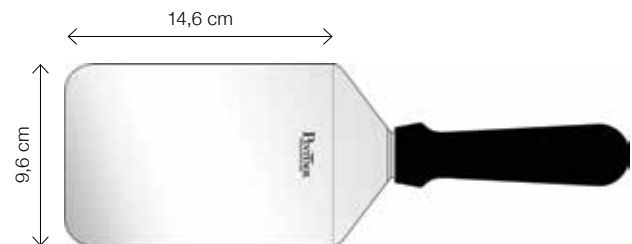

SPATOLA cm 18,9x7,6
Turner - Spatul - Spatel - Espátula
Cod. 78300024
Euro 15,26

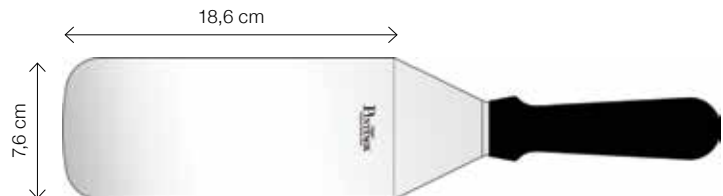

SPATOLA cm 19,8x9,6
Turner - Spatul - Spatel - Espátula
Cod. 78300025
Euro 19,80

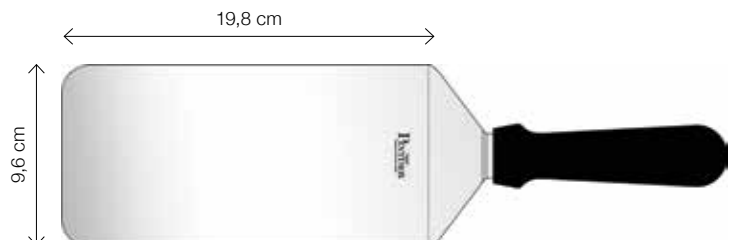

VENDITA A
MASTER
6 PZ
MASTER
SELLING
6 PCS

KITCHEN TOOLS

SPATOLA cm 24,8x9,6
Turner - Spatul - Spatel - Espátula
Cod. 78300026
Euro 24,68



SPATOLA FORATA
Turner perforated - Spatule perforée - Spatel
gelocht - Espátula perforada
Cod. 78300031
Euro 15,26

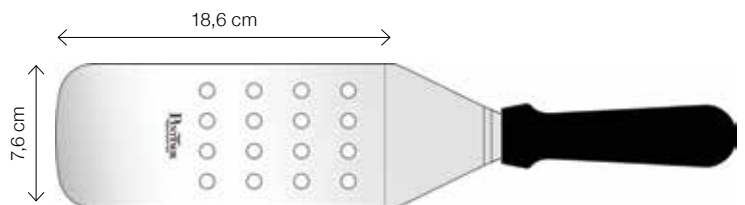

TAGLIA PASTA
Dough cutter - Spatul - Spatula grösse pasta
- Espátula pasta tamaño
Cod. 78300036
Euro 10,40

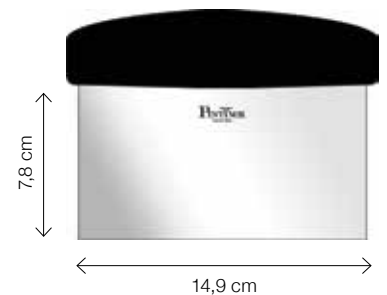

SCROSTATORE
Scraper - Spatule raclair - Schabmesser -
Espátula para rascar
Cod. 78300041
Euro 9,96



SPATOLA PESCE
Fish spatula - Spatule à poisson -
Fischwender - Espátula para pescado
Cod. 78300051
Euro 12,38

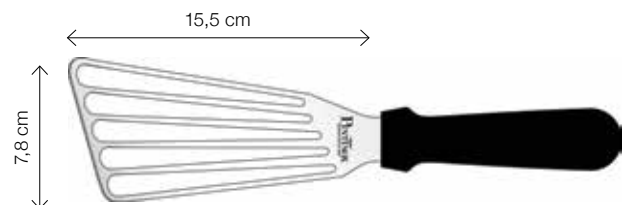

SPATOLA PANCAKE
Pancake turner - Spatule à pancake -
Pfannkuchenwender - Espátula para tortitas
Cod. 78300056
Euro 19,02

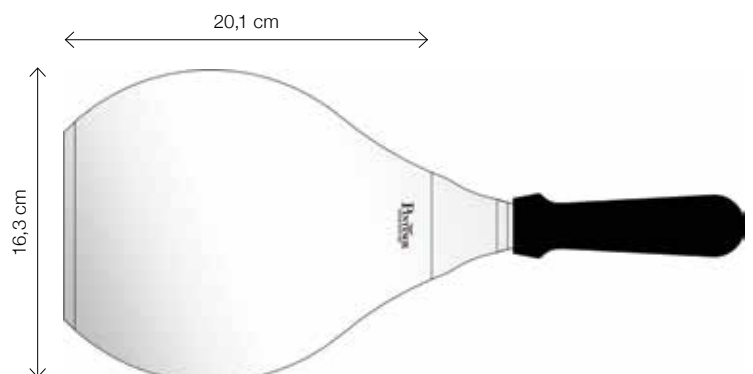

KITCHEN TOOLS

VENDITA A
MASTER
6 PZ
MASTER
SELLING
6 PCS

SPATOLA PER TORTA

Cake lifter - Spatule à tarte - Kuchenspachtel gross - Espátula para tarta

Cod.	Ø cm	size	Euro
78300061	25	medium	26,26
78300066	29,8	big	31,04



FORCHETTONE

Carving fork - Fourchette à viande - Tranchiergabel - Trinchador

Cod. 78300071

Euro 11,50



FORCHETTONE CURVO

Curved carving fork - Fourchette à viande courbée - Tranchiergabel gebogen - Trinchador curvo

Cod. 78300076

Euro 11,50



SPATOLA DRITTA

Straight turner - Spatule droite - Tranchiergabel gebogen - Espátula recta

Cod.	cm*	Euro
78300081	10,5	8,84
78300082	15,9	9,28
78300083	20,5	10,18
78300084	25,5	12,16
78300085	31,0	12,82
78300086	35,5	16,58



SPATOLA PIEGATA

Offset turner - Spatule courbée - Spatel gewinkelt - Espátula doblada

Cod.	cm*	Euro
78300091	7,7	9,28
78300092	11,7	9,74
78300093	16,0	11,50
78300094	20,3	12,60
78300095	24,7	13,04
78300096	29,7	17,24



GADGET - *Gadgets*

SCAVINO MELONE

Melon baller - Cuillère parisienne - Melonenausstecher -
Vaciador para melón

Cod.	Ø mm	Euro
78100001	10	8,40
78100002	15	8,40
78100003	22	8,40
78100004	25	8,40
78100005	30	8,40



SCAVINO POMODORO

Tomato shark - Equeuteur à tomate - Tomatenhai -
Vaciador para tomate

Cod. 78100016

Euro 8,40



DECORA / RIGA LIMONI

Lemon zester/Channel knife - Zesteur à citron - Zestenreisser/
kanneliermesser zitronen - Decorador / rallador de limones

Cod. 78100021

Euro 8,40



RIGA LIMONI

Lemon zester - Zesteur à citron - Zitronenschaber -
Rallador de limones

Cod. 78100022

Euro 8,40



SCANALATORE

Channel knife - Canneleur en V - Kanneliermesser - Acanalador

Cod. 78100023

Euro 8,40



SCAVINO DOPPIO

Double melon baller - Cuillère parisienne double - Doppel-
kugelausstecher - Vaciador doble

Cod. 78100011

Euro 11,10



COLTELLO AGRUMI

Citrus peeler - Couteau éplucheur d'agrumes -
Zitrusmesser - Cuchillo para cítricos

Cod. 78100026

Euro 8,82



KITCHEN TOOLS

VENDITA A
MASTER
6 PZ
MASTER
SELLING
6 PCS

PELAPATATE

Vegetable peeler - Econome - Kartoffelschäler - Pelapatatas
Cod. 78100031

Euro 8,40



COLTELLO POMPELMO

Grapefruit peeler - Couteau à pamplemousse - Grapefruit-
messer - Cuchillo para pomelo
Cod. 78100036

Euro 9,74



COLTELLO DECORATORE

Decorating knife - Couteau décoration fruits et légumes -
Dekor-messer - Cuchillo decorador
Cod. 78100041

Euro 10,18



LEVATORSOLO

Corer apple - Vide-pomme - Apfelentkerner - Descorazonador
Cod. 78100046

Euro 7,90



SCAVAZUCCHINE

Zucchini corer V shape - Couteau vide-courgettes -
Zucchinientkerner - Vaciador para calabacines
Cod. 78100051

Euro 7,90



COLTELLO POMODORO

Tomato knife - Couteau à tomate - Tomaten-messer -
Cuchillo para tomate
Cod. 78100061

Euro 10,64



COLTELLO FORMAGGIO

Cheese knife - Couteau à fromage - Käse-messer -
Cuchillo para queso
Cod. 78100066

Euro 11,56



KITCHEN TOOLS

ROTELLA TAGLIA PASTA

Pastry wheel plain - Roulette à découper - Teigschneider
- Cortador de pasta liso

Cod.	Ø mm	Euro
78100071	40	8,40
78100072	60	9,74



ROTELLA SEGHETTATA

Pastry wheel serrated - Roulette de pâtissier -
Teigschneider gezahnt - Cortador de pasta dentado

Cod.	Ø mm	Euro
78100076	40	8,40
78100077	60	9,74



ROTELLA DOPPIA

Pastry wheel double - Roulette double - Teigschneider
doppelt - Cortador de pasta doble

Cod.	Ø mm	Euro
78100081	40	10,18
78100082	60	12,00



ROTELLA PIZZA

Pizza cutter - Roulette à pizza - Pizzaschneider -
Cortador de pizza

Cod. 78100086

Euro 11,10



AFFETTA FORMAGGI

Cheese plane - Rabot à fromage - Käsehobel - Pala
para queso

Cod. 78100091

Euro 9,74



KITCHEN TOOLS

VENDITA A
MASTER
6 PZ
MASTER
SELLING
6 PCS

PELAPATATE LISCIO

(spessore struttura 2 mm)

Y-peeler plain - Econome lame lisse - Kartoffelschäler glatt

- Pelapatatas liso

Cod. 78100096

Euro 7,00



PELAPATATE SEGHETTATO

(spessore struttura 2 mm)

Y-peeler serrated - Econome lame dentelée - Kartoffelschäler

gezahnt - Pelapatatas dentado

Cod. 78100097

Euro 7,00



PELAPATATE JULIENNE

(spessore struttura 2 mm)

Y-peeler julienne - Econome lame julienne - Kartoffelschäler julienne -

Pelapatatas juliana

Cod. 78100098

Euro 7,00



GRATTUGIE - Graters

LAMA A NASTRO

Ribbon grater - Râpe à double tranchant - Reibe mit
bandklinge - Rallador corte en tiras
*per zucchine, cipolla, formaggio, cioccolato - for
zucchini, onion, cheese, chocolate - Pour courgettes,
oignon, fromage, chocolat - Für zucchini, zwiebel,
käse, schokolade - Para calabacín, cebolla, queso,
chocolate*

Cod. 78100106

Euro 12,90



LAMA A SCAGLIE

Shaver grater - Râpe à copeaux - Schaber - Rallador corte
en láminas
*per cioccolato, formaggio, tartufo - for chocolate, cheese,
truffle - Pour chocolat, fromage, truffes - Für schokolade,
käse, trüffel - Para chocolate, queso, trufa*

Cod. 78100107

Euro 12,90



LAMA GROSSA

Coarse grater - Râpe gros grain - Reibe mit grober klinge
- Rallador corte grueso
*per carote, formaggio, cavolo - for carrots, cheese,
cabbage - Pour carottes, fromage et chou - Für karotten,
käse, kohl - Para zanahoria, queso, col*

Cod. 78100101

Euro 12,90



LAMA MEDIA

Medium grater - Râpe grain moyen - Reibe mit
mittelgrober klinge - Rallador corte medio
*per cocco, zenzero, carote, formaggio tenero - for
coconut, ginger, carrots, soft cheese - Pour noix de
coco, gingembre, carottes, fromage tendre - Für
kokos, ingwer, karotten, weichkäse - Para coco,
jengibre, zanahoria, queso tierno*

Cod. 78100102

Euro 12,90



LAMA FINE

Fine grater - Râpe grain fin - Reibe mit feiner Klinge -
Rallador corte fino

per agrumi, peperoncino, formaggio, aglio, zenzero
- for citrus fruit, chili pepper, cheese, garlic, ginger
- Pour agrumes, piment, fromage, ail et gingembre
Für Zitrusfrüchte, Pfefferoni, Käse, Knoblauch, Ingwer
- Para cítricos, guindilla, queso, ajo, jengibre

Cod. 78100103

Euro 12,90



FORBICI - TRINCIAPOLLO

Scissor - Poultry shears

FORBICE PROFESSIONALE

Professional scissor - Ciseaux professionnels -
Profi-schere - Tijeras profesionales

Cod. 58734621

Euro 4,72



TRINCIAPOLLO PROFESSIONALE

Professional poultry shears - Cisaille à volaille
professionnelle - Geflügelschere - Tijeras trinchapollos
profesionales

Cod. 58730923

Euro 8,18



BARBEQUE

Barbeque

MOLLA BARBEQUE

Barbeque tongs - Pince à barbeque

Barbecue-zange - Pinza para barbacoa

Cod. 50918301

lungh. cm	master	Euro
42,5	6	18,14



PALA BARBEQUE

Barbeque turner - Pelle à barbeque

Barbecue-wender - Pala para barbacoa

Cod. 50918302

lungh. cm	master	Euro
44,5	6	14,68



FORCHETTONE BARBEQUE

Barbeque fork - Fourchette à barbeque

Barbecue-gabel - Tenedor para barbacoa

Cod. 50918303

lungh. cm	master	Euro
44,5	6	11,76



SPAZZOLA BARBEQUE

Barbeque brush - Pinceau barbeque
Barbecue-Bürste - Brocha - barbacoa
Cod. 50918304

lungh. cm	master	Euro
44,5	6	15,24



SET 4 PZ BARBEQUE

4 pc barbeque set - Barbeque set 4 pièces
4 tlg barbecue-set - Set 4 piezas barbacoa
Cod. 50918300

Euro 57,98



PIATTO PIANO

Flat Plate - Assiette Platte

Flacher Teller - Plato Llano

Cod. 50911022

Ø cm	spess. mm	Euro
22	0,7	13,06



PIATTO FONDO

Deep Plate - Assiette Creuse

Tiefer Teller - Plato Hondo

Cod. 509111..

Ø cm	spess. mm	Euro
20	0,7	11,98
22	0,7	13



PIETANZIERA

Serving dish - Gamelle ronde

Vorratsdose ohne dichtung - Fiambrera redonda

Cod. 53013300

Ø cm	Euro
12	9,74



SCODELLA SENZA ALETTE

Bowl - Bol

Fingerschüssel - Cuenco Sin Asas

Cod. 50911712

Ø cm	h cm	Lt	Euro
12	7,2	0,6	10,60



TAZZA PER BRODO

Soup cup - Tasse à bouillon

Suppenschüssel - Taza de caldo

Cod. 50912511

Ø cm	h cm	Lt	Euro
11,5	6	0,5	13,70



BICCHIERE

Glass - Verre

Glas - Vaso

Cod. 50912000

Ø cm	h cm	Lt	Euro
7,9	7,9	0,29	13,16



LEGUMIERA CON ALETTE

Vegetable dish with handles - Legumier avec poignées

Beilagenschüssel mit Griffen - Legumbrera con asas

Cod. 509045..

Ø cm	h cm	Euro
12	3	12,78
14	4	13,98
18	5,5	17,54
20	6	21,64



VASSOIO 4 SCOMPARTI BORDO PIANO SENZA PIEDINI

Tray 4 sectors

Plateau 4 secteurs, bord plat

Tablett 4 Sektoren mit flachem Rand, ohne Füße idem

Bandeja 4 secciones, bordo llano, sin pies

Cod. 5VS4BPSP

cm	spess. mm	Euro
40x30	0,8	37,86



VASSOIO 5 SCOMPARTI BORDO PIANO SENZA PIEDINI

Tray 5 sectors

Plateau 5 secteurs, bord plat

Tablett 5 Sektoren mit flachem Rand, ohne Füße idem

Bandeja 5 secciones, bordo llano, sin pies

Cod. 5VS5BPSP

cm	spess. mm	Euro
44x35	0,8	41,



CUCCHIAIO PER DETENUTI IN ALLUMINIO
E POLIPROPILENE

Convict spoon - Cuiller détenus
Gefangeneloeffel - Cuchara detenido
Cod. 00100001



master	Euro
500 (10x50 pcs)	2,54

FORCHETTA PER DETENUTI IN ALLUMINIO
E POLIPROPILENE

Convict fork - Fourchette détenus
Gefangenegabel - Tenedor detenido
Cod. 00100002



master	Euro
500 (10x50 pcs)	2,54

SCODELLA DETENUTI

Bowl - Bol
Schüssel - Cuenco
Cod. 50911520



Ø cm	h cm	Lt	Euro
22	5	1,2	17,94

PIATTO DETENUTI

Flat Plate - Assiette Platte
Flacher Teller - Plato Llano
Cod. 50910922



Ø cm	spess. mm	Euro
22	0,8	13,48



B A R G E L A T E R I A

B a r - I c e c r e a m

B a r - C r è m e G l a c é e

B a r - E i s

B a r - H e l a d o



Per alimenti
Suitable for foodstuffs
Apte au contact avec les aliments
Für Lebensmittel
Apto para alimentos



Garantito per lavastoviglie
Dishwasher safe
Inalterable dans lave-vaisselle
Spelmaschinenfest
Apto para lavavajillas

COLINO BAR 2 REBBI PESANTE INOX 18/10
Cocktail strainer heavy - Passoire à cocktail
Cocktailsieb - Filtro para cocktail
Cod. 78500381

Euro 5,34



COLINO BAR 2 REBBI LARGO
Cocktail strainer large - Passoire à cocktail
Cocktailsieb - Filtro para cocktail
Cod. 78500380

Euro 6,78



COLINO BAR SEMPLICE
Cocktail strainer 2 mm - Passoire à cocktail
Cocktailsieb - Filtro para cocktail
Cod. 78500385

Euro 8,88



COLINO COCKTAIL ELLISSE
Cocktail strainer - Passoire à cocktail
Cocktailsieb - Filtro para cocktail
Cod. 50951700

cm	master	Euro
22,5	24	8,96



COCKTAIL SHAKER 2 PZ
Shaker - Shaker
Shaker - Coctelera
Cod. 78500301

Lt	Euro
0,63	23,28



COCKTAIL SHAKER DE LUXE INOX 18/10
Shaker - Shaker
Shaker - Coctelera
Cod. 78500300

Lt	Euro
0,35	13,76



SHAKER BOSTON INOX 18/10
Shaker - Shaker
Shaker - Coctelera
Cod. 78500307

Lt	Euro
0,50	14,54



SPREMI LIME INOX 18/10

Lime squeezer - lime squeezer
Saftpresse - exprimidor de limón
Cod. 78500305

Euro 2,56



SPREMIAGRUMI

Citrus squeezer - Presse-citron
Zitronenpresse - Exprimidero
Cod. 50953C00

master	Euro
6	24,74



PORTA TOVAGLIOLI

Napkin holder - porte-serviettes
Serviettenhalter - Servilletero
Cod. 55014300

cm	Euro
11,5x8,5	5,72



PORTA BUSTINE

Sugar display -Porte-sachets de thé et sucre
Serviertablett Zucker/Tee - porta sobres azucar
Cod. 55014400

cm	Euro
10,5x5,5	5,42



SPILLONE PORTA SCONTRINI

Bill spike - Epingle porte-tickets
Couponnadel - Aguja porta tickets
Cod. 50916500

master	Euro
48	6,48



ZUCCHERIERA OVALE COMPLETA DI 2 CUCCHIAINI MOD. PITAGORA
 Oval sugar bowl with 2 tea/spoons - Sucrier oval avec 2 cuillères à café
 Ovale Zuckerdose mit 2 Löffeln - Azucarero ovalada con 2 cucharitas
 Cod. 50958600

cm	Euro
21x13	72,58



ZUCCHERIERA TONDA COMPLETA DI 2 CUCCHIAINI MOD. PITAGORA
 Round sugar bowl with 2 tea/spoons - Sucrier rond avec 2 cuillères à café
 Runde Zuckerdose mit 2 Löffeln - Azucarero redonda con 2 cucharitas
 Cod. 50958500

Ø cm	Euro
14	60,32



CAVATAPPI PROFESSIONALE
 Professional corkscrew - Tire-bouchon
 Profikorkenzieher - Sacacorchos
 Cod. 58734300
Euro 3,00



CAVATAPPI
 Corkscrew - Tire-bouchon
 Profikorkenzieher - Sacacorchos
 Cod. 58734100
Euro 9,60



DOSATORE DOPPIO ELLISSE

(1 oz - 2 oz)

Double jigger - Doseur double

Doppeldosiereinrichtung - Dosificador doble

Cod. 50951600

cm	master	Euro
23	12	8,86



MIXER ELLISSE

Mixer - Mélangeur

Mixer - Mezllador

Cod. 50951800

cm	master	Euro
25	24	4,14



SESSOLA

Ice/sugar big spoon - Cuillère à farine et glaçons

Serviertablett Zucker/Tee - Librador

Cod.	Lt	Euro
78500315	0,06	7,10
78500317	0,250	10,18
78500318	0,500	16,74
78500319	0,700	17,30



VASSOIO BAR TENDER INOX 18/0

Rectangular tray - Plateau rectangulaire - Tablett - Bandeja rectangular

Cod.	cm	h cm	Euro
53827825	25x20	0,8	19,34
53827835	35x10	0,8	16,90
53827836	35x20	0,8	22,08
53827840	40x10	0,8	17,16
53827842	40x20	0,8	22,88
53827850	50x10	0,8	20,36
53827852	50x20	0,8	28,80
53827860	60x10	0,8	25,26
53827862	60x20	0,8	30,44
53827870	70x20	0,8	38,88



VASSOI ANTISCIVOLO

NON-SLIP TRAYS

NEW

-Gomma antiscivolo + polipropilene
-Leggeri, pratici e resistenti

-Non-slip rubber + polypropylene
-Light, practical and resistant

VASSOIO TONDO ANTISCIVOLO

Round non-slip tray - Plateau antidérapant rond

Rundes rutschfestes Tablett - Bandeja redonda antideslizante

Cod.	Ø cm	Euro
53746528	28,0	4,70
53746535	35,5	5,30
53746540	40,5	6,90



VASSOIO RETTANGOLARE ANTISCIVOLO

Rectangular non-slip tray - Plateau antidérapant rectangulaire

Rechteckiges rutschfestes Tablett - Bandeja rectangular antideslizante

Cod. 53746045

Cod.	cm	Euro
53746041	41x30,5	5,90
53746045	45,7x36,5	7,30



VASSOIO TONDO ANTISCIVOLO CON BORDO IN ACCIAIO

Round non-slip tray with stainless steel edge

Plateau antidérapant rond avec bord en métal

Rundes rutschfestes Tablett mit Edelstahlrand

Bandeja redonda antideslizante con borde en acero

Cod.	Ø cm	Euro
53746735	35,5	7,20
53746740	40,5	9,30



TAPPO CHIUDI E VERSA CHAMPAGNE INOX 18/10

Close and pour champagne stopper inox 18/10 - Bouchon à champagne inox 18/10 - Champagnerverschluss Inox 18/10 mit Ausgießer Gießen und Schließen - Tapón "cierra y sirve" vino pvc

Cod. 50953305

Euro 15,90



TAPPO CHIUDI E VERSA VINO PVC BORDEAUX

Close and pour pvc wine stopper inox 18/10 - Bouchon à vin en PVC / bouchon pour bouteille de vin en PVC - Weinverschluss mit Ausgießer Gießen und Schließen - Tapón "cierra y sirve" vino pvc

Cod. 50953307

Euro 6,10



CHIUDIBOTTIGLIA INOX

Stainless steel bottle stopper - Bouchon en inox
Edelstahlflaschenverschluss - Tapon de inox

Cod. 50953A00

master	Euro
60	6,72



FORCHETTINA ANTIPASTO INOX ALBA

Hors d'oeuvre fork - Fourchette hors d'oeuvre
Vorspeisegabel - Tenedor

Cod. 19800009

master	Euro
120	0,78



CUCCHIAINO MOKA INOX INGLESE

Moka spoon - Cuillère à moka

Mokkalöffel - Cucharita moka

Cod.	master	Euro
199000CH	600	0,44



CUCCHIAINO MOKA INOX ECONOMICO

Moka spoon - Cuillère à moka

Mokkalöffel - Cucharita moka

Cod.	master	Euro
19900008	600	0,44



CUCCHIAIO BIBITA

Soda spoon - Cuillère à cocktail

Limolöffel - Cucharita refresco



Cod.	descriz.	cm	Euro pcs	Euro 6 pcs*
2150C636	GAMMA inox 18/10	22	2,10	12,86
1870C636	CAPRI inox	22	1,88	11,98
0810C636	PITAGORA inox 18/10	22	3,20	19,74
2230C636	BRASILIA inox 18/10	22	2,20	13,72
2240C636	AMERICA inox 18/10	22	2,28	13,72
1710C636	BETA inox 18/10	22	2,14	12,86
1980C636	ALBA inox	20,5	1,54	9,22
0800C636	BYRON inox 18/10	22	3,30	19,74
0810C6CG	PITAGORA inox 18/10 (antisc.)	30	5,92	36,22
2030C636	SYNTHESIS inox 18/10	22,1	2,66	15,92
0320C636	STRESA inox 18/10	21	1,76	10,50
2280C636	RITZ inox 18/10	19,5	3,08	18,46
1690C636	PALACE inox 18/10	22	2,66	15,92

*Confezioni con Chiavi 6 pz - ordine minimo 24 Chiavi (1 master) o multipli

*Packaging with "chiavi" 6 pcs - minimum order 24 "chiavi" (1 master) or multiple

POSATE CON CHIAVE Cutlery packed with "chiave" pack



GR 6
607 Cucchiaino
caffè - *Tea/coffee*
spoon - *Cuiller à*
café - *Kaffeelöffel* -
Cuchara café

GR 6
608 Cucchiaino
moka - *Moka*
spoon - *Cuiller à*
moka - *Mokkalöffel* -
Cucharita moka

GR 6
617 Forchettina
dolce 3 spine - *Pastry*
fork - *Fourchette à*
gateau - *Kuchengabel*
3 Zinken - *Tenedor*
postre 3 púas

GR 3
322 Paletta gelato
- *Ice cream spoon*
- *Cuiller à glace* -
Eislöffel - *Cuchara*
para helado

	Modello - Cod.	Euro	Euro	Euro	Euro
	Vittoriale 1640C...	14,42	14,42	18,48	-
	Concept 0450C...	17,72	17,08	19,74	-
	Tecna 0470C...	14,42	14,42	18,48	-
	Olivia 0490C...	14,42	14,42	18,48	-
	Euclide 0480C...	14,42	14,42	-	-
	Swing 0880C...	13,80	13,16	18,48	-
	Palladium 0590C...	13,46	12,84	18,02	7,02
	Ritz 2280C...	15,80	14,42	17,08	8,20
	Settecento 2050C...	11,90	11,90	13,16	-
	Liberty 1660C...	12,52	12,52	17,72	-
	Palace 1690C...	11,90	11,90	13,16	6,26
	Trend 1670C...	11,14	11,14	13,16	-
	Synthesis 2030C...	10,22	10,22	11,90	-
	Solaris 2170C...	10,56	10,50	12,52	-
	America 2240C...	7,92	7,92	10,34	4,92
	Gamma 2150C...	9,32	9,22	9,46	4,38
	Dolphin 1360C...	8,58	7,84	9,86	-
	Snake 1140C...	5,92	5,3	-	-

Confezioni con Chiavi 6 pz - ordine minimo 24 Chiavi (1 master) o multipli
Packaging with "chiavi" 6 pcs - minimum order 24 "chiavi" (1 master) or multiple



PALETTA GELATO

Ice cream spoon - Cuillère à glace
Eislöffel - Cuchara parar helado



Cod.	descriz.	cm	master	Euro
19900022	50/P inox	13,2	120	0,98
17100022	BETA inox 18/10	13,6	120	1,34
21500022	GAMMA inox 18/10	13,6	120	1,34
22400022	AMERICA inox 18/10	13,1	120	1,44
22300022	BRASILIA inox 18/10	13,1	120	1,44
22600022	SIRIO inox 18/10	13,7	120	1,74
08100022	PITAGORA inox 18/10	13,6	120	2,20
05900022	PALLADIUM inox 18/10	14,2	120	2,20
16900022	PALACE inox 18/10	14,4	120	1,88
08300022	BAGUETTE inox 18/10	13,7	120	2,20

DOSATORE GELATO

Ice cream scoop - Doseur pour glace
Eisportionierer - Dosificador helado

Cod.	cm	master	Euro
79004018	4,1	12	13,30
79004020	5,0	12	14,42
79004022	6,3	12	15,00



DOSATORE MANICO VUOTO

H-H ice cream soop - portionneur pour glace
Eisportionierer - dosificador helado mango hueco

Cod.	misura	Euro
78500396	medum	15,88
78500397	big	16,76



SPATOLA PER GELATO INOX

Ice cream spatula - Spatule à glace
Eisspachtel - Paleta para helado
Cod. 50952800

cm	master	Euro
18,5	100	4,52



SPATOLA PER GELATO IN POLICARBONATO
 PC ice cream spatula - Spatole à glace en PC
 PC Eisservier - Paleta para helado de PC

Cod.	colour	cm	master	Euro
50952707	black	27	100	3,20
50952708	transparent			



SPATOLA PER GELATO CON MANICO IN PLASTICA
 Ice cream spatula with plastic handle
 Spatule à glace avec manche en plastique
 Eisservier mit Kunststoffgriff
 Paleta para helado con mango de plástico

Cod.	colour	cm	master	Euro
50952701	white	30	100	8,04
50952702	green			
50952703	red			

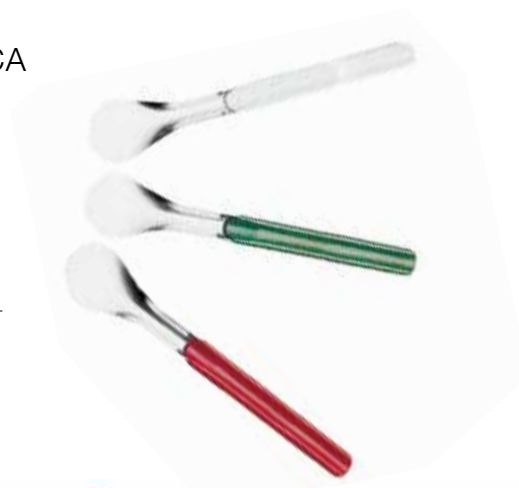

SPATOLA PER GELATO MANICO IN PLASTICA
 Ice cream spatula with plastic handle
 Spatule à glace avec manche en plastique
 Eisservier mit Kunststoffgriff
 Paleta para helado con mango de plástico

Cod.	colour	cm	master	Euro
50952601	red	26	600	5,84
50952602	blue			
50952603	yellow			
50952604	green			
50952605	white			
50952606	rose			
50952607	black			



PIATTINO CASSATA LISCIO

Ice cream plate - Plat à cassate

Cassata platte - Platilo

Cod. 50952013

Ø cm	master	Euro
13	-	8,30



PIATTINO PER COPPA BORDATO

Edged plate - Plat bordé

Eisschale Untersatz - Platillo

Cod. 50952113

Ø cm	master	Euro
13	-	6,86



COPPA GELATO CONICA

Conical ice cream goblet - Coupe à glace conique

Konische Eisschale - Copa para helado conica

Cod. 50950685

Ø cm	Lt	master	Euro
8,5	0,181	6	12,28



COPPA GELATO GAMBO BASSO

Ice cream goblet - Coupe à glace

Eisschale niedrig - Copa para helado

Cod. 50950210

Ø cm	Lt	master	Euro
10	0,180	6	7,84



COPPA GELATO GAMBO ALTO CILINDRICO

Ice cream goblet - Coupe à glace

Eisschale hoch - Copa para helado

Cod. 509504..

Ø cm	Lt	master	Euro
9	0,156	6	10,70
10	0,185	6	10,80



BACINELLA PER GELATO

ice cream basin

36x16,5 cm

Cod.	h cm	Euro
55019108	8	20,14
55019112	12	22,74
55019115	15	37,92
55019118	18	43,76
55019120	20	48,02



BACINELLA PER GELATO

ice cream basin

33x16,5 cm

Cod.	h cm	Euro
55019408	8	19,80
55019412	12	34,52
55019415	15	38,68
55019418	18	44,68
55019420	20	51,30



BACINELLA PER GELATO

ice cream basin

25,8x15,7 cm

Cod.	h cm	Euro
55019712	12	31,62
55019715	15	33,28
55019717	17	36,68



BACINELLA PER GELATO

ice cream basin

36x25 cm

Cod.	h cm	Euro
55019202	2	16,44
55019204	4	21,94
55019205	5	24,88
55019208	8	26,54
55019212	12	47,60
55019215	15	50,52
55019218	18	54,68
55019220	20	58,94



BACINELLA PER GELATO

ice cream basin

21x20 cm

Cod.	h cm	Euro
55019512	12	36,68
55019515	15	37,92
55019517	17	40,04
55019520	20	50,52



BACINELLA PER GELATO

ice cream basin

Cod.	cm	h cm	Euro
55019812	18x16,5	12,6	30,72
55019912	16,5x16,5	12	28,12



BACINELLA PER GELATO

ice cream basin

33x25 cm

cod.	h cm	Euro
55019302	2	16,44
55019304	4	22,74
55019308	8	26,10
55019312	12	47,60
55019315	15	50,52
55019318	18	54,68
55019320	20	58,94



BACINELLA PER GELATO

ice cream basin

42x20 cm

cod.	h cm	Euro
55019615	15	54,68
55019617	17	58,94
55019620	20	65,22
55019625	25	84,14



CARAPINA PER GELATO

20 Ø cm

cod.	h cm	Euro
55012525	25 ECO	46,34
55012625	25	54,66
55012612	12,8	39,14



COPERCHIO IN PLASTICA
plastic lid

cod.	cm	Euro
55013721	21x20	6,20
55013726	26x16,5	6,20
55013733	33x16,5	6,20
55013736	36x16,5	6,20



COPERCHIO PER CARAPINA
cover for ice cream roller container
20 Ø cm

cod.	Euro
55012820	86,28



SUPPORTO PER BACINELLE
support for basin
18x16,5 cm

cod.	Euro
55013818	18,12



SET 2 CARAPINE CON COPERCHIO
roller container with cover
for ice cream 2 pcs set
15 Ø cm

Cod.	cm	Euro
55012736	36x16,5	113,60



PORTA TOVAGLIOLI
napkin holder

Cod.	cm	h cm	Euro
57010700	10,6x10,6	13,5	23,96





C A F F E T T E R I A

C o f f e e s h o p



Per alimenti
Suitable for foodstuffs
Apte au contact avec les aliments
Für Lebensmittel
Apto para alimentos



Garantito per lavastoviglie
Dishwasher safe
Inalterable dans lave-vaisselle
Spuelmaschinenfest
Apto para lavavajillas

SERIE CONICA

INOX
18/10

Conica coffee pots

CAFFETTIERA

Coffee pot - Pot à lait/café

Kaffeekanne - Cafetera

Cod. 509560..

Lt	Euro
0,33	28,58
0,60	43,26
1,00	51,30
1,5	55,82
2,00	67,46



TEIERA

Tea pot - Théière

Teekanne - Tetera

Cod. 509567..

Lt	Euro
0,36*	36,56
1,25	52,94



LATTIERA

Milk pot - Pot à lait

Milchkanne - Lechera

Cod. 509573..

Lt	Euro
0,10	13,90
0,20	16,38
0,33	21,32
0,60	37,08
1,00	45,84
1,50	49,64
2,00	58,20



NEW

Executive coffee pots

LATTIERA

Milk pot - Pot à lait

Milchkanne - Lechera

Cod. 554070..

Lt		Euro
0,15	1	26,80
0,25	2	31,20
0,50	6	36,20
0,70	9	42,50
1,00	12	46,90
1,35	16	54,20
2,00	24	60,50



CAFFETTIERA

Coffee pot - Pot à lait/café

Kaffeekanne - Cafetera

Cod. 554000..

Lt		Euro
0,50	6	45,20
0,75	9	51,50
1,00	12	57,30
2,00	24	71,70



TEIERA

Tea pot - Théière

Teekanne - Tetera

Cod. 554040..

Lt		Euro
0,50	4	45,60
0,75	6	52,30







P A S T I C C E R I A

P a s t r y m a k i n g



Per alimenti
Suitable for foodstuffs
Apte au contact avec les aliments
Für Lebensmittel
Apto para alimentos



Garantito per lavastoviglie
Dishwasher safe
Inalterable dans lave-vaisselle
Spuelmaschinenfest
Apto para lavavajillas

ALZATA FILO PICCOLA

little riser

Cod. 50951028

Ø cm	h cm	Euro
24/28	15	13,28

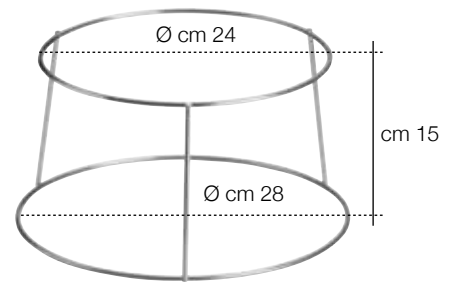

ALZATA FILO GRANDE

big riser

Cod. 50951036

Ø cm	h cm	Euro
32/36	20	15,54

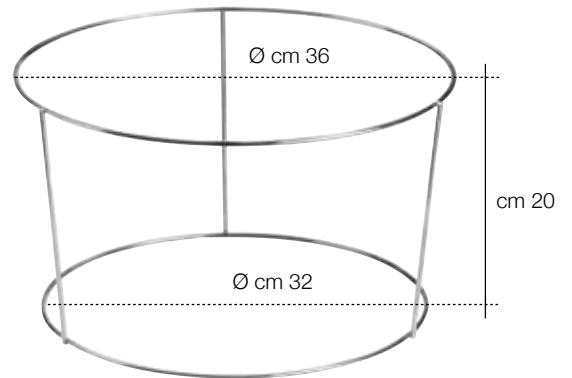

VASSOIO TONDO TENDER

Tender round tray

Cod. 538259..

Ø cm	Euro
24	8,38
28	10,72
32	12,42
36	14,12



CUCCHIAIO

paddle

Cod. 0620MKUL

cm	master	Euro
10	120	80,44



MIXER

mixer

Cod. 0620MKUQ

cm	master	Euro
10	120	64,48



JOLLY

joker

Cod. 0620MKUP

cm	master	Euro
10	120	69,62



VASSOI PER PASTICCERIA

Tray

VASSOIO RETTANGOLARE PER PASTICCERIA

Pastry deep tray - Plateau rectangulaire à pâtisserie - Tiefes Kuchentablett -
Bandeja rectangular pastelera

Cod. 50933827

cm	spess. mm	master	Euro
27x20	0,6	-	14,62



VASSOIO TRAMEZZINI IN ACCIAIO 18/0

Tray - Plateau - Tablett - Bandeja

Cod. 53727929

cm - h cm	spess. mm	master	Euro
29x21x2	0,8	10	13,52



VASSOI IMPILABILI

Tray

VASSOIO GN 1/1 IMPILABILE

Tray - Plateau - Tablett - Bandeja

Cod. 50933456

cm - h cm	master	Euro
53x32x7	10	92,96



BACINELLE PER PASTICCERIA

INOX
18/10

Deet tray

BACINELLA PER PASTICCERIA

Pastry deep tray - Plateau à pâtisserie - Einfaches tiefes Tablett - Bandeja honda pastelera
Cod. 509339..

cm - h cm	spess. mm	master	Euro
25x18x2	0,6	10	17,98
30x22x2	0,7	10	25,02
35x25x2,5	0,8	10	30,54



BACINELLA PER PASTICCERIA

Pastry deep tray - Plateau à pâtisserie - Einfaches tiefes Tablett - Bandeja honda pastelera
Cod. 509339..

cm - h cm	spess. mm	master	Euro
29x21x2	0,8	10	21,12
58x21x2	1,0	-	39,92



VASSOIO RETTANGOLARE PER PASTICCERIA

Pastry deep tray - Plateau à pâtisserie - Einfaches tiefes Tablett - Bandeja honda pastelera
Cod. 50933950

cm	spess. mm	master	Euro
50x36	1	-	38,12





B U F F E T



Per alimenti
Suitable for foodstuffs
Apte au contact avec les aliments
Für Lebensmittel
Apto para alimentos



Garantito per lavastoviglie
Dishwasher safe
Inalterable dans lave-vaisselle
Spuelmaschinenfest
Apto para lavavajillas



BUFFET INOX 509

Acciaio inox 18/10

Made in Italy 

La linea Buffet inox è l'elegante coordinato di oggetti per le nuove tendenze di presentazione libero servizio della moderna ristorazione.

LE FUNZIONI:

-Presentazione: per mettere ordine ed esaltare l'immagine della qualità dei cibi proposti.

-Caldo: i chafing dishes mantengono i cibi ad una temperatura ottimale per la conservazione dei sapori; sono disponibili:

1. Versione tradizionale con fornelli per alcool solido

2. Versione con resistenza elettrica che può essere anche usata nel sistema tradizionale.

-Freddo: L'obiettivo è di mantenere i cibi facilmente deteriorabili ad una bassa temperatura, come da grafici specifici. Il raffreddamento avviene mediante i rivoluzionari sacchetti di gel, che si adattano perfettamente alle pareti dei pezzi.

-Tutti i pezzi sono facilmente smontabili e lavabili in lavastoviglie.

The Buffet line elegantly coordinates the objects for the new presentation trend of catering, self-service.

ITS FUNCTIONS

-Presentation: to arrange things in an orderly fashion and highlight the quality image of the food.

-Heating: chafing dishes keep food at an optimum temperature to maintain their flavors; available in:

1. Traditional version with burner holders.

2. Electrical resistance version which can also be used in the traditional way.

-Cooling: the aim is to keep easily perishable food at a low temperature as per the specific graphs. Cooling is carried out with revolutionary gel packs, which adapt well to the walls of the pieces.

-All the pieces are easy to disassemble and are dishwasher safe.

PIATTO FORMAGGI

INOX
18/10



Tray for cheese

PIATTO FORMAGGI CON CUPOLA APRIBILE IN POLICARBONATO INDEFORMABILE CON TAGLIERE IN FAGGIO

Tray for cheese with openable non-deformable polycarbonate cloche with non-deformable laminar beech wooden board

Plateau à fromage avec coupole ouvrable en polycarbonate indeformable avec planche en hêtre lamellaire indeformable

Käseplatte mit holzbrett und rolltop

Bandeja para queso con cúpula abrible de polycarbonato indeformable y tabla de haya laminar indeformable

Cod. 50951448

Ø cm	h cm	Euro
47,5	34	266,56

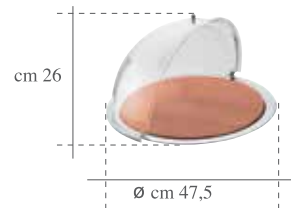

PIATTO FORMAGGI CON TAGLIERE IN FAGGIO LAMELLARE INDEFORMABILE

Tray for cheese with non-deformable laminar beech wooden board

Plateau à fromage avec planche en hêtre lamellaire indéformable

Käseplatte mit formbeständigem brett aus buche-schichtholz

Bandeja para queso con tabla de haya laminar indeformable

Cod. 50951452

Ø cm	h cm	Euro
47,5	2	116,94

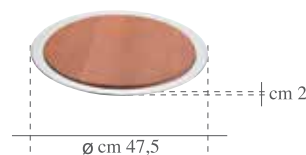

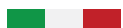

PORTA PANE

Brad trat

PORTA PANE CON CUPOLA APRIBILE IN POLICARBONATO INDEFORMABILE

Bread tray with openable non-deformable polycarbonate cloche

Porte-pain avec coupole ouvrable en polycarbonate indeformable

Btotschale mit Rolltop

Porta-pan con cúpula abriblede policarbonato indeformable

Cod. 50951348

Ø cm	h cm	Euro
47,5	34	266,56



PORTA PANE

Bread basket - Corbeille à pain

Btotschale - Porta pan

Cod. 50951352

Ø cm	h cm	Euro
47,5	10	116,94

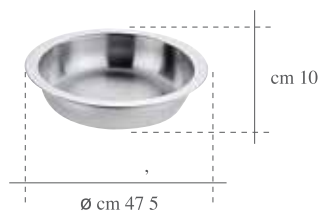



DISTRIBUTORI SUCCHI E BEVANDE CON COLONNA REFRIGERANTE E RUBINETTO TOMLINSON

**Juice and cold drink dispenser with
refrigerating pipe for ice cubes**

DISTRIBUTORE SUCCHI

Juice dispenser
Distributeur de jus
Saftspender
Surtidor de zumos
Cod. 50955416

Ø cm	Lt	Euro
16	4,5	425,16

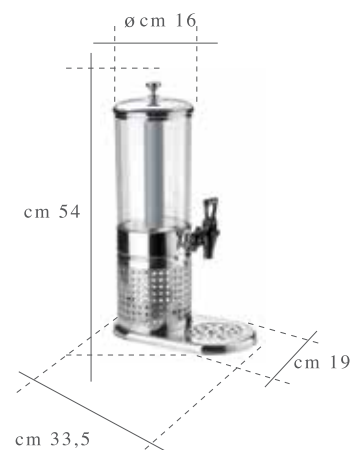

DISTRIBUTORE SUCCHI

Juice dispenser
Distributeur de jus
Saftspender
Surtidor de zumos
Cod. 50955420

Ø cm	Lt	Euro
20	9,5	458,90



DISTRIBUTORI BEVANDE CALDE

INOX
18/10



Hot drink dispenser

DISTRIBUTORE BEVANDE CALDE

CORREDATO DA RESISTENZA

ELETTICA 220 VOLTS 240 WATTS

Hot drinks dispenser provided with 220 V – 240 w electric resistance

Distributeurs de boissons chaudes avec résistance électrique 220 v – 240 w

Spender für warme getränke ausgestattet mit 220 v – 240 w elektrischer heizung

Distribuidores de bebidas calientes con resistencia eléctrica 220 v – 240 w

Cod. 50959527

Ø cm	Lt	Euro
24	8	705,04

DISTRIBUTORE BEVANDE

Drinks dispenser

Distributeur de boissons

Spender für warme getränke

Distribuidore de bebidas

Cod. 50959524

Ø cm	Lt	Euro
24	8	496,02

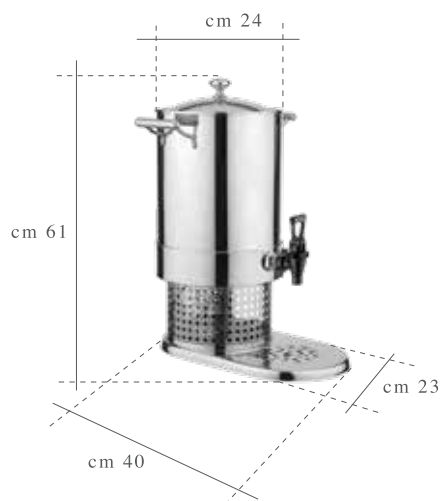

Temperatura Temperature (°C)

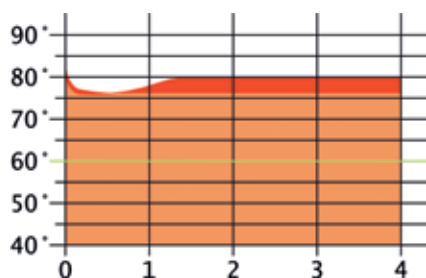

Tempo Time (h)

Diagramma del mantenimento della temperatura

Temperature maintenance diagram

Avvertenze vedi pag. 357 - **Instructions** see page 357

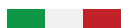

SISTEMI REFRIGERANTI

Refrigerated systems

PORTA YOGURT 19 FORI Ø mm 55
CORREDATO DI REFRIGERANTI
Refrigerated yoghurt dispenser
Porte-yogourt avec réfrigérants
Joghurt-halter mit kühlakku
Porta-yogur con refrigerantes
Cod. 50952947

Ø cm	h cm	Euro
47,5	10	230,58

Temperatura Temperature (°C)



Diagramma del mantenimento della temperatura
Temperature maintenance diagram



PORTA BURRO REFRIGERABILE
Refrigerated butter tray
Porte-beurre réfrigérable
Butterschale mit kühlakku
Porta-mantequilla refrigerable
Cod. 50933136

Ø cm	h cm	Euro
35	6,5	109,78

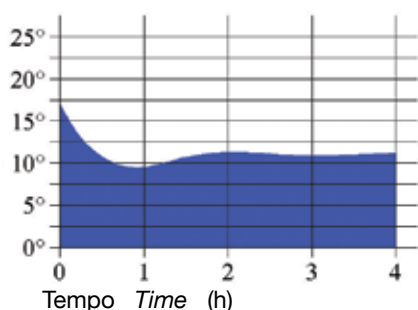
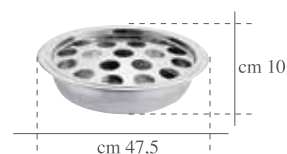
Temperatura Temperature (°C)



Diagramma del mantenimento della temperatura
Temperature maintenance diagram



Contenitore ghiaccio
Ice bucket
Recipient a glace
Eisbehälter
Recipiente para hielo

PIATTO AFFETTATI

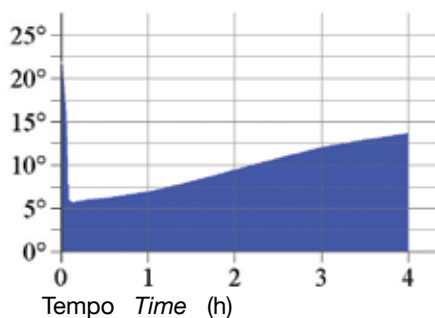
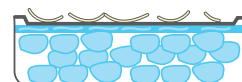
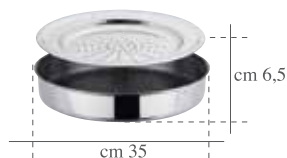
Tray for sliced salami

INOX
18/10



PIATTO AFFETTATI DOPPIA PARETE CON REFRIGERANTI E CUPOLA APRIBILE
IN POLICARBONATO INDEFORMABILE, INFRANGIBILE

Double wall tray for sliced salami and ham provided with refrigerators and non-deformable, unbreakable polycarbonate openable cloche

Plat à charcuterie double paroi avec refrigerants et coupole ouvrable en polycarbonate indeformable, incassable

Aufschnittplatte mit rolltop und kühlakku

Fuente de charcutería doble pared con refrigerantes y cúpula abrible de polycarbonato indeformable, irrompible

Cod. 50952548

Ø cm	h cm	Euro
47,5	29	276,08



PIATTO AFFETTATI

Tray - Plateau - Tablett - Bandeja

Cod. 50952452

Ø cm	Euro
40	42,54



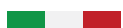

PIATTO AFFETTATI

PIATTO AFFETTATI DOPPIA PARETE CON REFRIGERANTI

Tray with double wall for sliced salami and ham provided with refrigerators

Plat à charcuterie double paroi avec réfrigérants

Aufschnittplatte mit doppelwand und kühlern

Fuente de charcutería doble pared con refrigerantes

Cod. 50952552

Ø cm	h cm	Euro
47,5	5	159,10



Diagramma del mantenimento della temperatura
Temperature maintenance diagram

MORSA PROSCIUTTO

Ham clamp - Porte jambon - Schinkenspanner - Porta jamón

Cod. 97200090

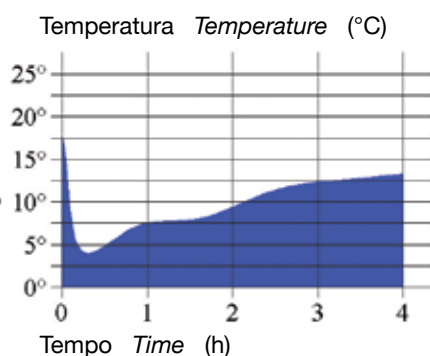
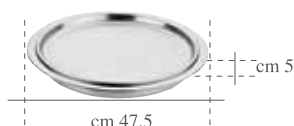
cm	h cm	Euro
58	17	203,60

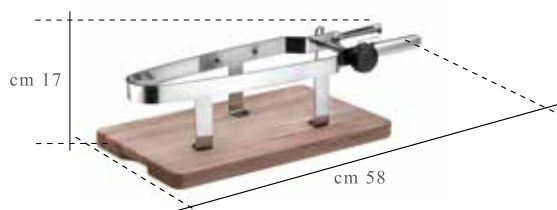

A richiesta è disponibile con base in resina
Resin base available on request

Base en résine disponible sur demande

Auf Anfrage mit Harzbasis

Base de resina disponible bajo pedido

CHAFING DISH

INOX
18/10

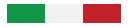

Chafing dish

CHAFING DISH QUADRATO GN 2/3 GASTRONORM composto da: Base traforata cm 36,5x33,5x20 - Vasca cm 33,5x30,5x10,5 - Bacinella alimenti cm 33x30x6 - Coperchio rimovibile cm 35x32x6 - 2 Fornelletti inox

· Gastronorm squared chafing dish composed of: Grill - tank - food seat - removable lid - heaters

· Réchaud carré gastronorm composé de: Base percée - cuve - bac aliments - couvercle démontable - fourneaux

· Chafing dish gn 2/3 mit brennpastenbehältern bestehend aus: Siebboden - wanne - lebensmittelbecken abnehmbarem deckel - kocher

· Hornillo cuadrado gastronorm compuesto por: Base perforada - recipiente - depósito alimentos - tapa desmontable - hornillos quemadores

Cod. 30595533

cm	h cm	Euro
46x40	26	371,06

CHAFING DISH QUADRATO GN 2/3 GASTRONORM CORREDATO DA RESISTENZA ELETTRICA 220 VOLTS / 700 WATT composto da: Base traforata cm 36,5x33,5x20 - Vasca cm 33,5x30,5x10,5 - Bacinella alimenti cm 33x30x6 - Coperchio rimovibile cm 35x32x6 - 2 Fornelletti inox

· Round chafing dish with non-deformable polycarbonate cloche provided with 220 v / 700 w electric resistance composed of: Grill - tank - food seat - hinged and removable lid

· Réchaud rond avec couple en polycarbonate indeformable avec resistance électrique 220 v / 700 w composé de: Base percée - cuve - bac aliments - couvercle à couple et démontable

· Rundes chafing dish mit formbeständiger polycarbonat-haube mit 220 v / 700 w elektrischem widerstand bestehend aus: Siebboden - wanne - lebensmittelbecken

· Hornillo redondo cúpula de polycarbonato indeformable con resistencia eléctrica 220 v / 700 w compuesto por: Base perforada - recipiente - depósito alimentos - tapa articulada y desmontable

Cod. 30595534

cm	h cm	Euro
46x40	21	544,96



Diagramma del mantenimento della temperatura
Temperature maintenance diagram



CHAFING DISH ROTONDO CON CUPOLA IN POLICARBONATO INDEFORMABILE
composto da: Base traforata - Vasca ø cm 49,5 x 10 - Bacinella alimenti ø cm 40 x 7
- Coperchio cupola ø cm 48,5 x 26 - 2 Fornelletti inox

· Round chafing dish with non-deformable polycarbonate cloche composed of: Grill - tank - food seat - hinged and removable lid - heaters

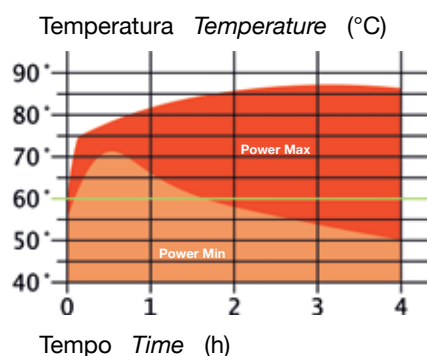
· Réchaud rond avec couple en polyc. indeform. composé de: Base percée - cuve - bac aliments - couvercle articulé et démontable - fourneaux

· Chafing dish rund mit brennpastenbehältern bestehend aus: Siebboden - wanne - lebensmittelbecken - kocher

· Hornillo redondo con cúpula de polycarbonato indeformable y stufas compuesto por: Base perforada - recipiente - depósito alimentos - tapa articulada y desmontable - hornillos quemadores

Cod. 30595540

Ø cm	h cm	Euro
49,5	47	399,74

CHAFING DISH ROTONDO CON CUPOLA IN POLICARBONATO CORREDATO
DA RESISTENZA ELETTRICA 220 VOLTS / 700 WATT composto da: Base traforata
- Vasca ø cm 49,5 x 10 - Bacinella alimenti ø cm 40 x 7 - Coperchio cupola ø cm 48,5
x 26 - 2 Fornelletti inox

· Round chafing dish with non-deformable polycarbonate cloche provided with 220 v – 700 w electric resistance composed of: Grill - tank - food seat - hinged and removable lid

· Réchaud rond avec couple en polycarbonate indeformable avec resistance électrique 220 v – 700 w composé de: Base percée - cuve - bac aliments - couvercle à coupole et démontable

· Rundes chafing dish mit formbeständiger polycarbonat-haube mit 220 v – 700 w elektrischem widerstand bestehend aus: Siebboden - wanne -lebensmittelbecken

· Hornillo redondo cúpula de polycarbonato indeformable con resistencia eléctrica 220 v – 700 w compuesto por: Base perforada - recipiente - depósito alimentos - tapa articulada y desmontable

Cod. 30595541

Ø cm	h cm	Euro
49,5	47	573,52



Diagramma del mantenimento della temperatura
Temperature maintenance diagram



CHAFING DISH

ZUPPIERA 2 STAZIONI composta da: Base traforata / Bagnomaria Gastronorm - Coperchio Gastronorm con spacco - 2 zuppiere semisferiche Lt 5 - 2 coperchi - 2 fornelli inox

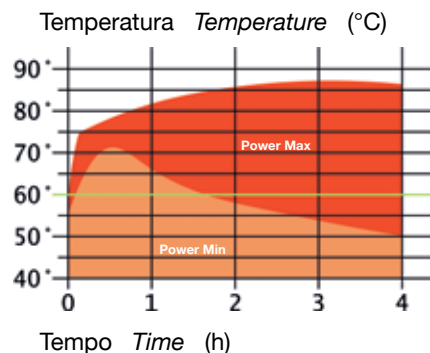
· 2 Soupe stations: Perforated stand, gastronorm bain marie, gastronorm lid, 2 soup bowls, 2 lids, 2 section soup-bowl - 2 heaters

· Soupière a 2 stations: base ajourée cm 56x35x34h - bain-marie gastronorm - couvercle gastronorm avec fente 2 bols semi-sphériques 5 Lt - 2 Couvercles - 2 fourneaux

· Suppenstation 1/1 - suppenstation 1/1 mit brennpastenbehältern: durchbrochene basis cm 56x35x34h, bain-marie deckel mit schlitze - 2 halbkugelige suppenschüsseln l 5 - 2 deckel - 2 kocher

· Sopera 2 staciones: base perforada cm 56x35x34h baño maria gastronomico - tapa con hendidura gastronomica 2 soperas semi esfericas - 2 tapas - 2 hornillos quemadores Cod. 30595556

cm	h cm	Euro
56x35	34	454,40

ZUPPIERA 2 STAZIONI CORREDATA DA RESISTENZA ELETTRICA 220 VOLTS 700 WATT cm 56x35x34 composto da: - Base traforata - Bagnomaria Gastronorm Coperchio Gastronorm con spacco - 2 zuppiere semisferiche Lt 5 - 2 coperchi - 2 fornelli inox

· 2 Soupe stations provided with 220 v – 700 w electric resistance composed of: perforated stand, gastronorm bain marie, gastronorm lid, 2 soup bowls, 2 lids, 2 section soup-bowl

· Soupière a 2 stations avec résistance électrique 220 v – 700 w composée de: base ajourée cm 56x35x34h - bain-marie gastronorm - couvercle gastronorm avec fente - 2 bols semi-sphériques 5 Lt - 2 Couvercles

· Suppenstation 1/1 mit 220 v – 700 w elektrischer heizung bestehend aus: durchbrochener basis cm 56x35x34h, - bain-marie deckel mit schlitze - 2 halbkugeligen suppenschüsseln l 5 - 2 deckeln

· Sopera 2 staciones con resistencia eléctrica 220 v – 700 w compuesta por: base perforada cm 56x35x34h - baño maria gastronomico - tapa con hendidura gastronomica - 2 soperas semi esfericas - 2 Tapas

Cod. 30595563

cm	h cm	Euro
56x35	34	643,02

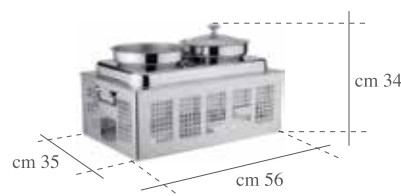
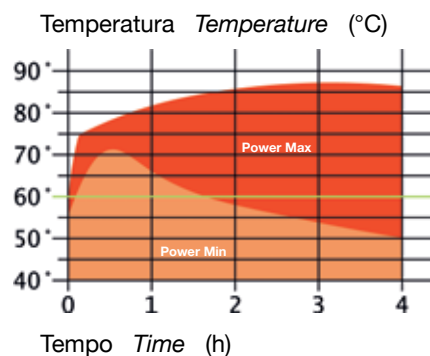

CHAFING DISH GN 1/1 GASTRONORM composto da: Base traforata cm 54x33x19,5h - Bagnomaria Gastronorm cm 51x30,5x11h - Bacinella Gastronorm 1/1 cm 50x29,5x6,5h Coperchio Gastronorm a cupola rettangolare cm 53x32,5x9h rimovibile - 2 fornelli inox

· Chafing dish composed of: Perforated stand 56x35x34 cm - gastronorm - bain marie - gastronorm basin 1/1 - Gastronorm lid 2 heaters

· Chafing dish composé de: Base ajourée cm 56x35x34h - bain-marie gastronorm - bac gastronorm 1/1 - couvercle - gastronorm à cloche rectangulaire - 2 Fourneaux

· Chafing dish 1/1 mit brenn pastenbehältern bestehend aus:

Durchbrochener basis cm 56x35x34 - bain marie gastronorm - deckel - 2 kochern

· Hornillo completo compuesto por: Base perforada cm56x35x34h - baño maria gastronómico - cubeta gastronómica - tapa gastronómica - Campana rectangular - 2 hornillos quemadores

Cod. 30595555

cm	h cm	Euro
64x40	29	385,80

CHAFING DISH GN 1/1 GASTRONORM CORREDATO DA RESISTENZA ELETTRICA 220 VOLTS 700 WATT composto da: Base traforata cm 54x33x19,5h - Bagnomaria Gastronorm cm 51x30,5x11h - Bacinella Gastronorm 1/1 cm 50x29,5x6,5h - Coperchio Gastronorm a cupola rettangolare cm 53x32,5x9h rimovibile - 2 fornelli inox

· Chafing dish provided with 220 v – 700 w électrique résistance composed of: perforated stand 56x35x34 cm - gastronorm bain marie -gastronorm basin 1/1gastronorm lid

· Chafing dish avec résistance électrique 220 v – 700 w composée de:

base ajourée cm 56x35x34h - bain-marie gastronorm - bac gastronorm 1/1 - couvercle gastronorm à cloche rectangulaire

· Chafing dish 1/1 mit 220 v – 700 w elektrischer heizung widerstand bestehend aus: durchbrochener basis cm 56x35x34 - bain marie gastronorm deckel

· Hornillo completo compuesto par: base perforada baño maria - gastronómico - cubeta gastronómica - tapa gastronómica de campana rectangular

Cod. 30595554

cm	h cm	Euro
64x40	29	585,10



Diagramma del mantenimento della temperatura
Temperature maintenance diagram



GIREVOLI

INOX
18/10

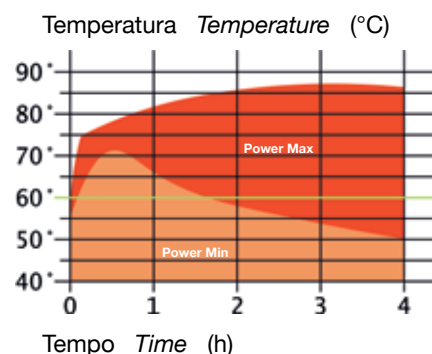

Turnable food-warmer

PAELLERA GIREVOLE composta da: Base con ralla girevole - Anello traforato - Tegame con fondo termodiffusore e coperchio ø cm 50 - 5 candele

· Turnable frying pan for paella consisting of: Tournable plate - Perforated ring - Pan 50 cm with sandwich botton and lid - 5 Candle

· Pêle à paella tournante composée de: Base tournante - Support ajouré - Poêle et fond thermodiffuseur cm 50 et couvercle - 5 Bougies

· Drehbare paellera komplett besteht aus: Fuß mit Löchern - Bain-Marie und Deckel mit Schlitz G/N - Halbkogelige Suppenschüssel Liter 5 mit Deckel - mit 5 Kerze

· Paellera giratoria compuesto de: Base con balanceo giratorio - Anillo perforado, Rustidera con fondo difusor y tapa cm 50 - 5 Bujías

Cod. 50953954

Ø cm	h cm	Euro
50	23	466,94

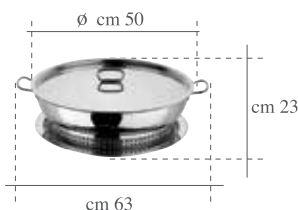

SCALDAVIVANDE GIREVOLE composto da: Base con ralla girevole - Anello traforato, Tegame con fondo termodiffusore e coperchio ø cm 50 - Set porcellana 5 settori con 1 ciotola centrale - 5 candele

· Turnable food-warmer consisting of: Tournable plate, Perforated ring - Pan 50 cm with sandwich botton and lid - 5 sector chinaware with inner bowl - 5 Candles

· Chauffe-plats tournant composée de: Base tournante - Support ajouré, Poêle et fond thermodiffuseur cm 50 et couvercle - Set porcelaine 5 secteurs avec bol intérieur - 5 Bougies

· Rolling center pieze komplett besteht aus: Fuß mit Löchern - Bain-Marie und Deckel mit Schlitz G/N - Halbkogelige Suppenschüssel Liter 5 mit Deckel - mit 5 Kerze - Porzellan Einsatz 6 tlg

· Calienta-alimentos giratorio compuesto de: Base con fondo giratorio - Anillo perforado - Rustidera con fondo difusor y tapa cm 50 - Set porcelana 5 sectores con 1 bol central - 5 Bujías

Cod. 50953953

Ø cm	h cm	Euro
50	24	665,38

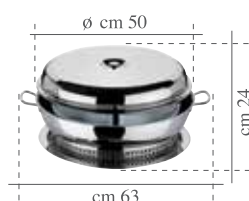

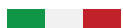

PORTA BROCCHE

Jug holder

PORTA BROCCHE COMPLETO DI 3 BROCCHE Lt 1,5

Jug holder complete with 3 1,5 Lt jugs

Porte-carafes avec 3 carafes 1,5 Lt

Tablett, für 3 krüge à 1,5 Lt

Porta-jarras jarras 1,5 Lt

Cod. 50951A00

Ø cm	h cm	Euro
37	7,2	151,90

PORTABROCCHE

Jug holder - Porte-carafes - Tablett - Porta-jarras

Cod. 50951A0S

Ø cm	Euro
37	51,42



FOTO ESEMPIO
EXAMPLE PHOTO

BROCCA TERMICA INOX 18/10

Pitcher - Cruche

Krug - Lanzador

Cod. 557590..

Lt	Euro
1	30,46
1,5	32,22
2	37,78



Technical informations

ACCIAIO INOX 18/10 - AISI 304 viene fornito esclusivamente dalle principali acciaierie europee.

La sua eccezionale resistenza alla ruggine, la brillantezza e le caratteristiche igieniche soddisfano i requisiti della moderna gastronomia. Esso infatti resiste agli acidi contenuti nei prodotti alimentari, nei detersivi.

L'acciaio Inox 18/10 è antiurto e particolarmente adatto al lavaggio in lavastoviglie.

POLICARBONATO - PC é un polimero di pregio racchiude alcune caratteristiche della plastica, dell'acciaio e del vetro. La trasparenza si avvicina al 90%. La resistenza meccanica alla deformazione ha una elevata resistenza all'urto. L'elevata stabilità dimensionale viene garantita fino ad una temperatura di 130 gradi. In presenza di fiamma è autoestinguente. Non resiste a: soluzioni alcaline, acetone, ammoniaca, benzolo ed alcool metilico. Il materiale è sicuro dal punto di vista fisiologico e può andare a contatto con gli alimenti.

VETRO delle ciotole è per alimenti, infrangibile.

PORCELLANA è per alimenti, non presenta tracce di sostanze dannose, né cessioni di elementi pericolosi.

FAGGIO Il tagliere in faggio lamellare è garantito a norma di legge, è trattato per non assorbire odori e ritenere umidità. Deve essere lavato a mano ed asciugato.

RESISTENZE Sono adatte ad un voltaggio di 220 Volts. Conformi alle norme CEE.

18/10 AISI 304 STAINLESS STEEL is supplied almost exclusively by the main European steelworks. Its exceptional rust resistance, its brilliance and hygienic qualities satisfy the requirements of modern gastronomy; in fact, it resists the acids contained in foodstuffs, detergents and is shockproof. 18/10 steel is dishwasher safe.

POLYCARBONATE - PC is a valuable polymer that has some characteristics from plastics, steel and glass. Its transparency is close to 90%. Its strain strength has a high impact strength. Its high dimensional stability is guaranteed up to a 130-degree temperature. In the presence of flame, it is self-extinguishing. Warning: it does not withstand: alkaline solutions, acetone, ammonia, benzol and methyl alcohol. The material is safe from the physiological point of view and can get in touch with food.

GLASS of bowls is suitable for food usage and is unbreakable.

CHINA is suitable for food usage and does not contain harmful substances or release dangerous elements.

BEECHWOOD The laminar beechwood board complies with the rules in force and is treated not to absorb smells and humidity. It must be hand washed and dried with care.

RESISTANCES Suitable for a 220 Volt In compliance with CEE norm.



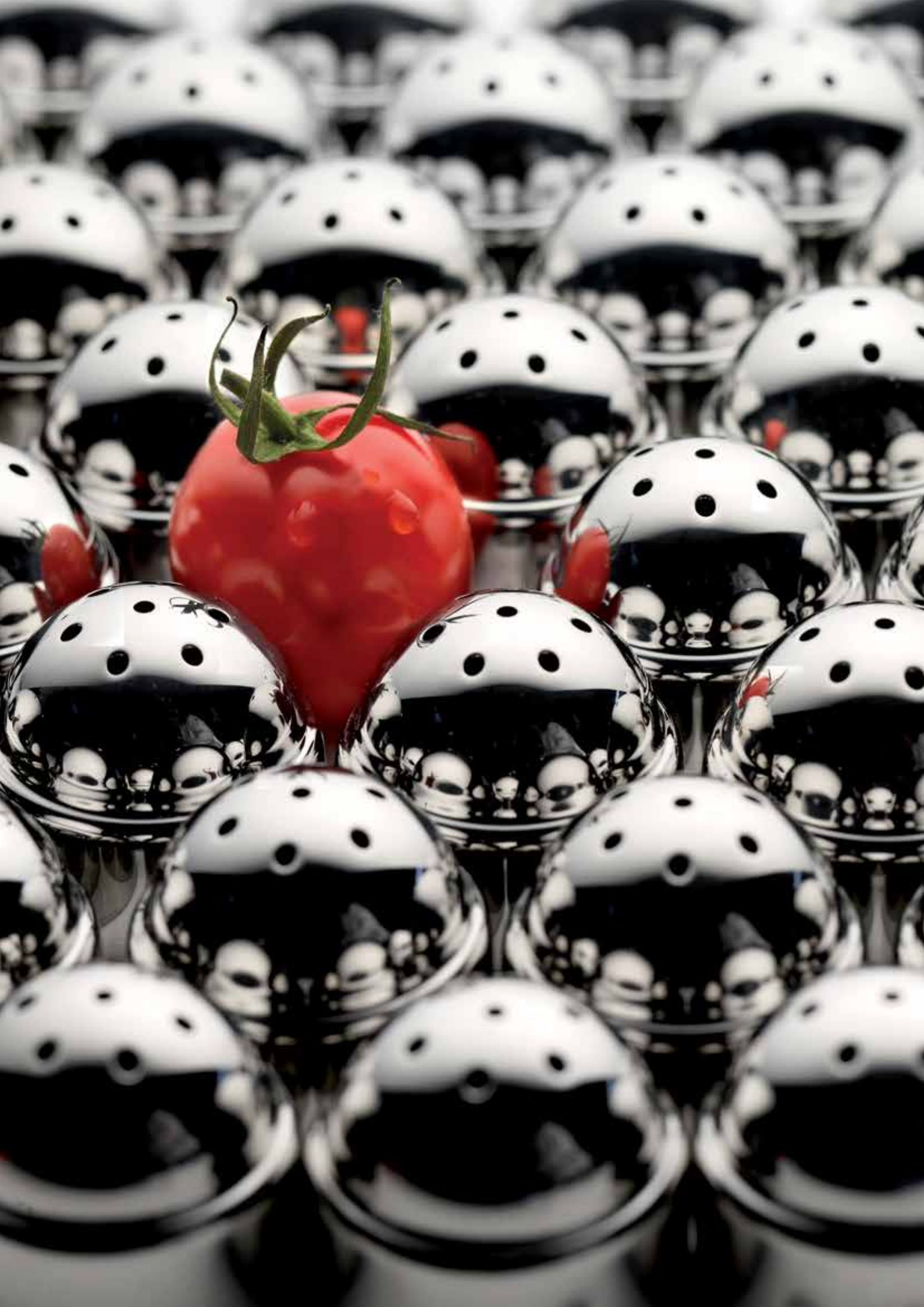

R I C A M B I

S p a r e P a r t s

PiècesDeRechanges

E r s a t z t e i l e

PiezasDeRepuesto



Per alimenti
Suitable for foodstuffs
Apte au contact avec les aliments
Für Lebensmittel
Apto para alimentos



Garantito per lavastoviglie
Dishwasher safe
Inalterable dans lave-vaisselle
Spuelmaschinenfest
Apto para lavavajillas

RICAMBI BUFFET

Spare parts for buffet line

CUPOLA TONDA

Dome lid - Cloche ronde

Rolltop - Campana

Cod. 97150111

cm	Euro
47,5	67,02



FORNELLETTO INOX

Heater - Fourneau

Kocher - Quemadores

Cod. 97200078

cm	h cm	Euro
9-18	6,5	9,82



PORTA BURRO

butter tray - Porte-beurre

Butterschale - Porta-mantequilla

Cod. 50933135

Ø cm	Euro
35	22,00



SET PORCELLANA TONDA DA FORNO

Composta da 1 ciotola tonda + 5 settori - 6 sector chinaware with inner bowl -

Porcelaine à secteurs avec bol intérieur - Runder porzellan einsatz - Juego porcelana

Cod. 97150103

Ø cm	h cm	Euro
49	9	194,64

CIOTOLA INTERNA CENTRALE

Central bowl - Coupe intérieure centrale

Innere, zentralschüssel - Cuenco interior central

Cod. 97150104

Ø cm	h cm	Euro
19	9	25,22

SETTORE INTERNO 1/5

Internal sector - Secteur intérieur

Einsatz runde Schale - Medialuna interior

Cod. 97150105

cm	h cm	Euro
28	14	34,30



BUFFET

CONTENITORE ISOLANTE CON COLONNA REFRIGERANTE

Dispenser tank - Récipient isolant

Isolierbehälter - Porte aislante

Cod.	Ø cm	Euro
97150038	16	104,12
97150039	20	121,46



GLACETTE REFRIGERANTE (cm 20x9,8)

Refrigerating brick - Briquette réfrigérante

Kühlakku - Refrigerado

Cod. 97150276

Euro 2,66



BROCCA IN VETRO

Jug - Carafe

Krüge - Jarra

Cod. 97200096

Lt	Euro
1,5	35,28



RICAMBIO CARAFFA TERMICA

Vacuum jug

Cod. 97100111

Euro 9,26



TAGLIERE IN FAGGIO

Beechwood board - Hachoir en hêtre

Küchenbrett aus Buche - Tabla de haya

Cod. 97150115

Euro 41,62



Il tagliere in faggio e' garantito a norma di legge, trattato per non assorbire odori ed umidità. Deve essere lavato a mano ed asciugato.

The beechwood board complies with the rules in force. It has been treated not to absorb smells and humidity. It must be hand-washed and dried with care.

Le hachoir en hêtre est garanti conforme aux dispositions légales, traité pour n'absorber ni odeurs ni humidité. Il est recommandé de le laver à la main et de le sécher soigneusement.

Das Brett entspricht den gesetzlichen Bestimmungen. Es wurde gegen Geruch- bzw Feuchtigkeitsaufnahme behandelt. Handspülen und Abtrocknen.

La tabla de haya está garantizada de conformidad con las leyes, está tratada para no absorber olores ni humedad. Lavarla a mano y secarla cuidadosamente.

BUFFET

RESISTENZA 220 VOLTS 700 WATT CON REGOLATORE PER CHAFING DISH

220 v 700 w electric resistance for chafing dish
Résistance électrique 220 v – 700 w pour chauffe-plat
220 v 700 w elektrischer Widerstand für Chafing dish
Resistencia eléctrica 220 v – 700 w para hornillo
Cod. 97150118

Euro 238,48



RESISTENZA 220 VOLTS 50 WATT CON REGOLATORE PER VASSOIO BRIOCHES

220 v 50 w electric resistance for heating tray for brioches
Résistance électrique 220 v – 50 w pour plateau chauffant pour viennoiseries
220 v 50 w elektrischer Widerstand für brioches ausgestattet
Resistencia eléctrica 220 v – 50 w para bandeja para bollería
Cod. 97150770

Euro 218,76



RUBINETTO COMPLETO SMONTABILE INTERAMENTE IN PPL PPL faucet

Robinet démontable complètement en PPL
Abnehmbarer hahn ganz aus PPL
Grifo desmontable completamente de PPL
Cod. 97150221

Euro 67,92



RICAMBI OLIERE-FORMAGGERE PITAGORA

Spare parts for Pitagora cruet sets and cheese bowls

VETRO OLIERA

Oil / vinegar glass - Burette - Ersatzflasche für essig/öl - Ampolla

Cod. 97200040 **Euro 10,44**



SALVAGOCCIA

Plastic drop-catcher - Protège-goutte

Ausgiesser plastik essig/öl - Impide-gotas

Cod. 97200054 **Euro 1,60**



CAPPUCCIO IN ACCIAIO INOX 18/10 PER VETRO OLIERA

18/10 Cup for oil/vinegar glass - Capuchon en acier 18/10 pour burette

Metallkappe - Capuchón ampolla de acero inoxidable

Cod. 97200056 **Euro 3,62**



VETRO SALE E PEPE

Salt/pepper glass - Salière - Ersatzglas pfeffer/salz - Salero

Cod. 97200045 **Euro 5,12**



CAPPUCCIO IN ACCIAIO INOX 18/10 PER SALINO

18/10 Salt cup for salt/pepper glass - Capuchon pour salière en acier inoxydable

18/10 - Metallkappe salz - Capuchón salero de acero inoxidable

Cod. 97200052 **Euro 3,52**



CAPPUCCIO PEPE IN ACCIAIO INOX 18/10

18/10 Pepper cup for salt/pepper glass - Capuchon pour poivrière en acier

inoxydable 18/10 - Metallkappe pfeffer - Capuchón pimienta de acero inoxidable

Cod. 97200051 **Euro 3,52**



CAPPUCCIO UNIV. INOX 18/10 PER STUZZICADENTI INCARTATI 18/10

Universal toothpicks cup - Capuchon en acier inoxydable 18/10 pour cure-

dents - Universalkäppchen zahnstocher - Capuchón univ. Para palillos limpiadientes en empapelados

Cod. 97200053 **Euro 2,98**



VETRO PER FORMAGGERA

Cheese bowl glass - Verre pour fromagère

Glas für käsedose - Cristal para quesera

Cod. 97200050 **Euro 6,94**



RICAMBI OLIERE E FORMAGGERE

Spare parts for cruet sets and cheese bowls

VETRO OLIERA

Oil/vinegar glass - Burette - Menage - Ampolla
Cod. 97200060

Mod.	Euro
Nouvelle Cuisine / Progetto	7,28



SALVAGOCCIA

Plastic drop-catcher - Protège-goutte - Stöpsel - Protector de gotas
Cod. 97200062

Mod.	Euro
Nouvelle Cuisine / Progetto	0,90



CAPPUCCIO 18/10 PER VETRO OLIERA

18/10 Cup for oil/vinegar glass - Capuchon 18/10 pour burette
Kappe für Menage 18/10 - Capuchón ampolla 18/10
Cod. 97200059

Mod.	Euro
Nouvelle Cuisine / Progetto	3,32



SALINO

Salt/pepper glass - Salière - Salzstreuer - Salero
Cod. 97200061

Mod.	Euro
Nouvelle Cuisine / Progetto	1,96



CAPPUCCIO IN ACCIAIO INOX 18/10 PER SALINO

18/10 Salt cup for salt/pepper glass
Capuchon en acier inoxydable pour salièr
Salzstreuerkappe aus Stahl inox
Capuchón salero de acero inoxidable
Cod. 97200058

Mod.	Euro
Nouvelle Cuisine / Progetto	3,06



RICAMBI OLIERE E FORMAGGERE

CAPPUCCIO IN ACCIAIO INOX 18/10 PER PEPE/STUZZICADENTI

18/10 Pepper/toothpicks cup for salt/pepper glass

Capuchon en acier inoxydable pour poivrière

Kappe aus Stahl inox für Pfeffer Salz-und Zahnstocher

Capuchón pimienta/palillos de acero inoxidable

Cod. 97200057



Mod.	Euro
Nouvelle Cuisine / Progetto	3,06

CAPPUCCIO UNIV. INOX 18/10 PER STUZZICADENTI INCARTATI

18/10 Universal toothpicks cup

Capuchon en acier inoxydable 18/10 pour cure-dents

Universalkäppchen zahnstocher

Capuchón univ. Para palillos limpiadientes en empaquetados

Cod. 97200053



Mod.	Euro
Nouvelle Cuisine / Progetto	2,98

VETRO PER FORMAGGERA

Cheese bowl glass

Verre pour fromagère

Glas für Käsedose

Cristal para quesera

Cod. 97200035



Mod.	Euro
Nouvelle Cuisine / Progetto	2,26

CONDIZIONI GENERALI DI VENDITA

General sales conditions

Con il conferimento dell'ordine il Cliente accetta integralmente le condizioni di vendita e di consegna di seguito elencate:

PREZZI L'attuale quotazione a listino si intende per merce resa franco nostro stabilimento. La merce è venduta ai prezzi in Euro in vigore all'atto della spedizione dell'ordine. La ditta si riserva la facoltà di modificare in qualsiasi momento i prezzi di vendita. Per imballo e confezionamento addebito 1%.

CONSEGNA Per giorno di consegna viene inteso quello indicato nella bolla di consegna controfirmata dal corriere. Il termine di consegna, essendo vincolato alle possibilità del momento e potendo variare per motivi indipendenti dalla volontà della ditta, è inteso come approssimativo e non impegnativo. Il mancato rispetto da parte nostra del termine di consegna concordato non dà diritto al Cliente di annullare l'ordine, protrarre il pagamento, richiedere un indennizzo, compenso o penale qualsiasi.

RECLAMI La merce viaggia a rischio e pericolo del destinatario anche nel caso in cui la merce viaggi in porto franco. Il Cliente deve verificare la merce all'atto della consegna. Tutti i reclami riferentesi alla qualità della merce devono essere comunicati a mezzo raccomandata o fax entro otto giorni dal ricevimento della merce pena la decadenza di qualsiasi diritto. Per qualsiasi contestazione è competente esclusivamente il Foro di Brescia.

PAGAMENTO Da convenirsi all'ordine.

La merce rimane di riservato dominio della ditta PINTI INOX fino all'avvenuto pagamento.

Per tutto quanto non previsto esplicitamente si fa riferimento a quanto previsto dal Codice Civile.

Gli articoli esposti nel presente catalogo si intendono a solo titolo informativo e senza alcun impegno da parte della PINTI INOX.

MISURE E CAPACITÀ sono puramente indicative.

La PINTI INOX si riserva il diritto insindacabile di apportare, anche senza preavviso, tutte le modifiche e le migliori richieste da esigenze commerciali e/o tecniche di qualsiasi natura.

RESA E TRASPORTO In Italia su richiesta:

Area Nord 1,5% del valore della fattura

Area centro 2,5% del valore della fattura

Area Sud 3% del valore della fattura

Isole 4% del valore della fattura

Per ordini inferiori a 1000 € di imponibile saranno addebitati 25 € per gestione imballo.

URGENZE in caso di necessità particolari, è possibile richiedere la spedizione di un ordine nelle 24 ore con corriere espresso priority: se confermato, il costo del servizio è di € 40,00 più eventuali spese di trasporto

Qualora fosse richiesta la sponda idraulica verrà addebitato il costo del servizio di euro 50,00 per consegna.

*When the order is conferred, the customer will integrally accept the selling and delivery conditions listed herebelow:
PRICES the current price list is to be considered ex our factory. The goods are sold with prices in EURO valid at the time of the shipping. We reserve the right to decide about the modification of the current selling prices in every up to moment. For packing and packaging there will be a debit of 1%.*

DELIVERY the delivery day is the one indicated in the delivery note countersigned by the courier. The delivery term is approximate and not binding as it is tied up to the current possibilities and may vary because of reasons not related to the company's will. Should we not observe the agreed delivery terms, the customer has not the right to cancel the order, postpone the payment, require any sort of refund, compensation or penalty.

COMPLAINTS the goods are carried at consignee's risk. The customer must verify the goods upon receipt. Any sort of complaint concerning the quantity or the quality of the goods must be sent by registered mail within eight days after the receipt of the goods, or any right for complaining will be lost. Any arbitration or disputes will be governed by the Italian laws.

PAYMENT to be agreed with the order.

Pinti Inox is the sole owner of the goods until the full payment is effected.

For whatever not explicitly mentioned hereabove, please refer to the Civil Code.

The articles shown in the present catalogues have merely an informative function, and do not bind Pinti Inox.

MEASUREMENTS AND CAPACITIES are indicative.

Pinti Inox reserves the unquestionable right to either modify or improve any item-even without notice-because of market and/or technical requirements.

MINIMUM ORDER 1000,00 euros.



ESPOSITORI

D i s p l a y

P r é s e n t o i r

W a n d a u s s t e l l e r

E x p o s i t o r

ESPOSITORI

Display

ESPOSITORE ORANGE SPOT
CON 45 GANCI E RIPIANO
Display with 45 hooks and shelf
Cod. 99900053

largh.	prof.	altez.	Euro
70	50	220	678,04

STRUTTURA ESPOSITORE
PER ORANGE SPOT
Orange Spot display
99900161

Euro 300,38

GANCI PER ORANGE SPOT
Orange Spot hooks
99900056

Euro 6,22

MODULO PORTAPOSATE
PER ORANGE SPOT
(14 NICCHIE)
cutleries shelf Orange Spot display
99900057

Euro 169,52

RIPIANO PER ORANGE SPOT
Orange Spot shelf
99900160

Euro 97,94



PINTINOX®
made in italy

Astra



espositore Orange Spot con serie Astra
Orange Spot display with Astra kitchentools

99900053 espositore Orange Spot con 45 ganci
Orange Spot display with 45 hooks

PINTINOX®
made in italy



espositore Orange Spot con serie Ellisse
Orange Spot display with Ellisse kitchentools

99900053 espositore Orange Spot con 45 ganci
Orange Spot display with 45 hooks



espositore Orange Spot con coltelli Professional
Orange Spot display with Professional knives

99900053 espositore Orange Spot con 45 ganci
Orange Spot display with 45 hooks



espositore Orange Spot con serie Molle
Orange Spot display with Tongs

99900053 espositore Orange Spot con 45 ganci
Orange Spot display with 45 hooks

ESPOSITORI

STRUTTURA ESPOSITORE GDO GDO display

Cod.	largh.	prof.	altez.	Euro
99900120	66,5	60	220	372,56
99900121	100	60	220	441,20
99900122	133	60	220	486,48



RIPIANO CON PORTA PREZZO FRONTALE shelve with frontal datastrips

Cod.	cm	Euro
99900177	66,5x50	84,22
99900176	100x50	72,48
99900175	133x50	57,46



BARRA PER GANCI bar for hooks

Cod.	cm	Euro
99900144	66,5	31,58
99900145	100	31,58
99900146	133	38,64



GANCI (10 PZ)
hooks (10 pcs)
99900147

Euro 84,46

PORTA PREZZO (10 PZ)
price holder (10 pcs)
99900148

Euro 10,56



ESPOSITORI

BASE ESPOSITORE PALL BOX
 POSATE PER CROWNER
 PERSONALIZZATI (6 nicchie)
 Display - Présentoir
 Wandaussteller - Expositor
 Cod. 99900112

largh.	prof.	altez.	Euro
60	40	200	369,42



crowner Palace
 Palace crowner
 99900113
Euro 67,66



crowner Privilege
 Privilege crowner
 99900114
Euro 67,66

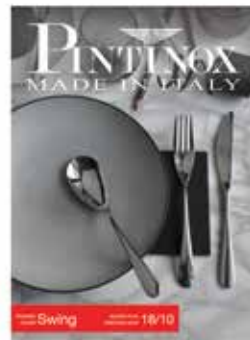

crowner Swing
 Swing crowner
 99900115
Euro 67,66

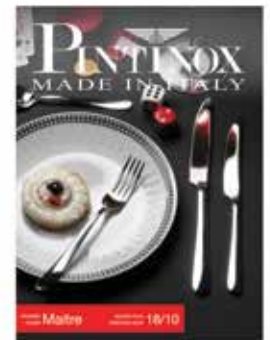

crowner Maitre
 Maitre crowner
 99900116
Euro 67,66

ESPOSITORI

ESPOSITORE PALL BOX PER PADELLE
 Pall box display for frying pans - Présentoir
 - Wandaussteller - Expositor
 Cod. 99900014

largh.	prof.	altez.	Euro
40	66	136	67,06



ESPOSITORE SENZA GANCI
 Wall display (without hooks) - Présentoir mural (sans crochets)
 Wandaussteller (ohne Haken) - Expositor de pared (sin ganchos)
 Cod. 99900028

lunghezza	prof.	altez.	Euro
100	44	220	507,02

GANCI (50 PZ PER CONFEZIONE)
 Hooks (50 pcs) - Crochets (50 pcs)
 Haken (50 er pack) - Ganchos (50 piezas)
 Cod. 99900032 **Euro 194,62**

RIPIANO PIANO (3 PZ PER CONFEZIONE)
 Flat shelf (3 pcs) - Rayon horizontal (3 pcs)
 Flachboden (3 er pack) - Estante plano (3 piezas)
 Cod. 99900033

cm	Euro
50	194,62



ESPOSITORI

ESPOSITORE CURVO

Bent display (without shelves) - Présentoir courbé (sans rayons)

Bogenförmiger Aussteller (ohne Böden) - Expositor curvado (sin estantes)

Cod. 99900027

lungh.	prof.	altez.	Euro
100	44	220	555,76



GANCI (50 PZ PER CONFEZIONE)

Hooks (50 pcs) - Crochets (50 pcs)

Haken (50 er pack) - Ganchos (50 piezas)

Cod. 99900032 **Euro 189,88**

RIPIANO PIANO (3 PZ PER CONFEZIONE)

Flat shelf (3 pcs) - Rayon horizontal (3 pcs)

Flachboden (3 er pack) - Estante plano (3 piezas)

Cod. 99900036

cm	Euro
30	194,62

PORTAQUATERNA LEGNO (15 PZ PER CONFEZIONE)

4 pz wooden display (15 pcs) - Présentoir en bois 4 pcs (15 pcs)

Holzdisplay 4 Tlg (15 er pack) - Expositor 4 piezas (15 piezas)

Cod. 99900035

lungh.	prof.	altez.	Euro
18,5	15	27	132,58



PORTAQUATERNA PINTINOX

Display 4 pcs - Présentoir 4 pcs

Display 4 Tlg - Expositor 4 piezas

Cod. 92903052

lungh.	prof.	altez.	Euro
15,5	14	10,2	12,82

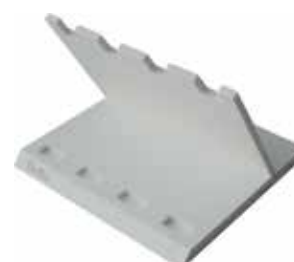







SEZIONE ESPLICATIVA

Technical Information

Information Technique

Technische Informationen

Información Técnica

LA COSTRUZIONE DELLE POSATE

Cutlery manufacturing process



1
Lamiera da coils
Coils sheet



2
Tranciatura
Blanking



3
Laminazione
Rolling



4
Ritrancio tazza
Bowl cutting



5
Coniatura
Embossing



6
Lucidatura prodotto
finito
*Polishing finished
product*

LA COSTRUZIONE DEI COLTELLI

Knife manufacturing process

a) Coltello monoblocco con lama temperata *Solid knife with hardened blade*



1 AISI 420
Barra d'acciaio
Steel bar

2
Partic. fucinato
Forged piece

3
Partic.
ritranciato
Blanked piece

4
Partic. molato
Ground piece

5
Prodotto finito
Finished product

b) Coltello con manico cavo e lama fucinata *Hollow handle knife with forged blade*



1
Lama fucinata
Forged blade

2
Manico cavo
Hollow handle

L'ACCIAIO

The steel

Acciaio inox 18/10

Acciaio 18% cromo

Le diverse qualità di acciai per posate. L'acciaio inox 18/10 AISI 304 e inox 18% cromo AISI 430, vengono forniti esclusivamente dalle principali acciaierie europee. La loro eccezionale resistenza alla ruggine, la brillantezza e le caratteristiche igieniche soddisfano i requisiti della moderna gastronomia; essi infatti resistono agli acidi contenuti nei generi alimentari e nei detersivi ed è antiurto. Gli acciai AISI 304 e 430 sono particolarmente adatti al lavaggio in lavastoviglie.

18/10 stainless steels

18% chrome stainless steels

The different steel grade used for cutlery. Pinti 18/10 AISI 304 and 18% CHROME AISI 430 stainless steel are supplied almost exclusively by the main European steelworks. Their exceptional rust resistance, their brilliance and hygienic qualities satisfy the requirements of modern gastronomy; in fact, they resist the acids contained in foodstuffs, detergents and they are shockproof. 18/10 and 18% chrome are dishwasher safe.



USO E MANUTENZIONE

Use and care advise

Inossidabilità dell'acciaio usato per coltelli e lame.

In ottemperanza alla legge n° 126 del 10/04/91 "Norme per l'informazione del consumatore" si informano gli utilizzatori di lame e coltelleria circa l'uso corretto del prodotto per evitare fenomeni corrosivi.

- Lavare le lame immediatamente dopo l'uso.
- Utilizzare detergenti neutri o debolmente alcalini.
- Evitare di strofinare lame e coltelli con:
 - a) prodotti abrasivi soprattutto se contenenti cloro.
 - b) pagliette metalliche o sintetiche.
- Non impiegare per il lavaggio ipocloriti (candeggina), né detergenti contenenti cloro o cloruri liberi.
- Asciugare subito dopo il lavaggio con panni morbidi e assorbenti.
- L'asciugatura in lavastoviglie non é in genere sufficiente ad evitare rischi di corrosione, é pertanto necessario effettuare una accurata asciugatura a mano immediatamente dopo il ciclo di lavaggio. Le precauzioni succitate sono indispensabili per evitare danni irreparabili a lame e coltelli.

Rust-proof characteristics of steel used to make knives and blades.

In compliance with the Law no. 126 of 10/04/1991 "Information to Consumer", we hereby advise users of blades and knives on proper use of these products to prevent their rusting.

- *Wash blades immediately after use.*
- *Use neutral or slightly alkaline detergents.*
- *Do not rub blades and knives with:*
 - a) *abrasive products (mainly those containing chlorine)*
 - b) *metal or synthetic wools.*
- *Do not wash with hypochlorites (bleach) or detergents containing chlorine or free chlorides.*
- *Dry immediately after washing with a soft or absorbing cloth.*
- *Generally, drying in dish-washers does not prevent rusting; therefore, dry manually immediately after washing in dish-washers. Strictly follow these advices to prevent blades and knives from being irreparably damaged.*



MANUTENZIONE DELL'ANTIADERENTE

Care advise of non-stick coatings



Lavare la padella nuova, per pulire è sufficiente acqua calda e detersivo.

Clean the new frying-pan, clean with hot water and detergent.



Adatta al lavaggio in lavastoviglie
Can be washed in dish-washer



Permette di cucinare anche senza grassi
No-fat cooking



Detersivi e pagliette abrasivi possono essere usati solo se l'etichetta ne indica la compatibilità con i rivestimenti antiaderenti.

Detergents or abrasive steel wools can be used only if the label indicates they are compatible with non-stick coatings.



Prima dell'uso condizionare con olio.
Brush with oil before use.



Evitare le temperature estreme durante la cottura (non superare i 260°C).

Avoid extreme temperatures during cooking (do not exceed 260°C).



I marchi dei rivestimenti antiaderenti più avanzati tecnologicamente permettono anche l'utilizzo di utensili metallici.

The most technologically advanced trademarks of non-stick coatings can also be used with metal utensils.



LUXURY
COLLECTION

STONE WASHED

	LEONARDO 050200..	VITTORIALE 164200..	BAGUETTE 083200..	SETTECENTO 205400..	PALACE 169200..	CASALI 210200..	STRESA 032400..
01	€ 4,74	€ 5,28	€ 4,74	€ 4,08	€ 3,74	€ 3,74	€ 2,42
02	€ 4,74	€ 5,28	€ 4,74	€ 4,08	€ 3,74	€ 3,74	€ 2,42
03	€ 7,30	€ 7,88	€ 7,30	€ 6,60	€ 6,28	€ 5,92	€ 4,78
L3	-	-	-	-	-	-	€ 3,30
04	€ 4,64	€ 5,16	€ 4,64	€ 3,96	€ 3,74	€ 3,74	€ 2,42
05	€ 4,64	€ 5,16	€ 4,64	€ 3,96	€ 3,74	€ 3,74	€ 2,42
06	€ 7,18	€ 7,74	€ 7,18	€ 6,50	€ 6,28	€ 5,92	€ 4,68
07	€ 2,74	€ 2,84	€ 2,74	€ 2,42	€ 2,42	€ 2,30	€ 1,56
08	€ 2,74	€ 2,84	€ 2,74	€ 2,42	€ 2,42	€ 2,30	€ 1,56
10	€ 17,96	€ 17,96	€ 17,96	€ 17,08	€ 19,40	€ 17,08	€ 14,20
11	€ 8,28	€ 8,86	€ 8,28	€ 7,42	€ 7,86	€ 7,86	€ 6,20
12	€ 8,28	€ 8,86	€ 8,28	€ 7,42	€ 7,86	€ 7,86	€ 6,20
17	€ 3,62	€ 3,62	€ 3,62	€ 2,74	€ 2,74	€ 2,74	€ 1,76
20	€ 12,00	€ 12,00	€ 12,00	€ 11,40	€ 11,40	€ 11,40	€ 7,16
39	€ 4,48	€ 5,16	€ 4,48	€ 3,84	€ 3,74	€ 3,62	€ 2,32
67	€ 7,30	-	€ 7,30	-	€ 6,28	-	€ 4,78



TXT

	SETTECENTO 205300..	PALACE 169300..	CASALI 210300..
01	€ 6,60	€ 6,28	€ 5,10
02	€ 6,60	€ 6,28	€ 5,10
03	€ 10,72	€ 10,40	€ 8,26
CC	€ 15,74	€ 15,74	-
04	€ 6,48	€ 6,28	€ 5,10
05	€ 6,48	€ 6,28	€ 5,10
06	€ 10,72	€ 10,40	€ 8,26
CD	€ 15,64	€ 15,64	€ 13,86
07	€ 4,42	€ 4,42	€ 3,46
08	€ 4,42	€ 4,42	€ 3,46
10	€ 22,14	€ 24,46	€ 19,82
11	€ 12,48	€ 12,92	€ 10,60
12	€ 12,48	€ 12,92	€ 10,60
17	€ 4,76	€ 4,76	€ 3,92
20	€ 16,46	€ 16,46	€ 14,14
39	€ 6,38	€ 6,28	€ 5,00



ALCHIMIQUE GOLD

	SETTECENTO OJA400..	CASALI OYA200..	VITTORIALE OVA200..	BAGUETTE OWA200.. <i>on demand</i>	PALACE OZA200.. <i>on demand</i>
01	€ 9,68	€ 9,32	€ 10,86	€ 10,34	€ 9,32
02	€ 9,68	€ 9,32	€ 10,86	€ 10,34	€ 9,32
03	€ 12,44	€ 11,74	€ 13,68	€ 13,12	€ 12,10
04	€ 9,58	€ 9,32	€ 10,76	€ 10,22	€ 9,32
05	€ 9,58	€ 9,32	€ 10,76	€ 10,22	€ 9,32
06	€ 12,30	€ 11,74	€ 13,58	€ 13,00	€ 12,10
07	€ 7,14	€ 7,04	€ 7,58	€ 7,48	€ 7,14
08	€ 7,14	€ 7,04	€ 7,58	€ 7,48	€ 7,14
10	€ 41,48	€ 41,48	€ 42,32	€ 42,32	€ 43,74
11	€ 17,84	€ 18,28	€ 19,28	€ 18,72	€ 18,28
12	€ 17,84	€ 18,28	€ 19,28	€ 18,72	€ 18,28
17	€ 7,48	€ 7,48	€ 8,34	€ 8,34	€ 7,48
20	€ 27,88	€ 27,88	€ 28,46	€ 28,46	€ 27,88
39	€ 9,44	€ 9,22	€ 10,76	€ 10,10	€ 9,32
67	-	-	-	€ 13,12	€ 12,10



ALCHIMIQUE BRONZE

	SETTECENTO 0JB400..	CASALI 0YB200..	BAGUETTE 0WB200..	VITTORIALE 0VB200.. <i>on demand</i>	PALACE 0ZB200.. <i>on demand</i>
01	€ 13,08	€ 12,74	€ 13,72	€ 14,26	€ 12,74
02	€ 13,08	€ 12,74	€ 13,72	€ 14,26	€ 12,74
03	€ 15,96	€ 15,30	€ 16,66	€ 17,22	€ 15,62
04	€ 12,96	€ 12,74	€ 13,62	€ 14,16	€ 12,74
05	€ 12,96	€ 12,74	€ 13,62	€ 14,16	€ 12,74
06	€ 15,84	€ 15,30	€ 16,52	€ 17,10	€ 15,62
07	€ 8,56	€ 8,46	€ 8,90	€ 9,02	€ 8,56
08	€ 8,56	€ 8,46	€ 8,90	€ 9,02	€ 8,56
10	€ 44,52	€ 44,52	€ 45,40	€ 45,40	€ 46,84
11	€ 20,58	€ 21,04	€ 21,44	€ 22,02	€ 21,04
12	€ 20,58	€ 21,04	€ 21,44	€ 22,02	€ 21,04
17	€ 8,90	€ 8,90	€ 9,78	€ 9,78	€ 8,90
20	€ 29,52	€ 29,44	€ 30,12	€ 30,12	€ 29,52
39	€ 12,86	€ 12,62	€ 13,50	€ 14,16	€ 12,74
67	-	-	€ 16,66	-	€ 15,62



ALCHIMIQUE TITANIUM

	SETTECENTO 0JC400..	CASALI 0YC200..	PALACE 0ZC200..	VITTORIALE 0VB200.. <i>on demand</i>	BAGUETTE 0WC200.. <i>on demand</i>
01	€ 13,08	€ 12,74	€ 12,74	€ 14,26	€ 13,72
02	€ 13,08	€ 12,74	€ 12,74	€ 14,26	€ 13,72
03	€ 15,96	€ 15,30	€ 15,62	€ 17,22	€ 16,66
04	€ 12,96	€ 12,74	€ 12,74	€ 14,16	€ 13,62
05	€ 12,96	€ 12,74	€ 12,74	€ 14,16	€ 13,62
06	€ 15,84	€ 15,30	€ 15,62	€ 17,10	€ 16,52
07	€ 8,56	€ 8,46	€ 8,56	€ 9,02	€ 8,90
08	€ 8,56	€ 8,46	€ 8,56	€ 9,02	€ 8,90
10	€ 44,52	€ 44,52	€ 46,84	€ 45,40	€ 45,40
11	€ 20,58	€ 21,04	€ 21,04	€ 22,02	€ 21,44
12	€ 20,58	€ 21,04	€ 21,04	€ 22,02	€ 21,44
17	€ 8,90	€ 8,90	€ 8,90	€ 9,78	€ 9,78
20	€ 29,52	€ 29,44	€ 29,52	€ 30,12	€ 30,12
39	€ 12,86	€ 12,62	€ 12,74	€ 14,16	€ 13,50
67	-	-	€ 15,62	-	€ 16,66



TREASURE GOLD

	SETTECENTO 08A000..	BAGUETTE 06A000..	SYNTHESIS 15A000..	OLIVIA 14A000..
01	€ 8,90	€ 9,44	€ 8,46	€ 9,68
02	€ 8,90	€ 9,44	€ 8,46	€ 9,68
03	€ 11,42	€ 12,10	€ 11,08	€ 12,44
04	€ 8,78	€ 9,44	€ 8,46	€ 9,68
05	€ 8,78	€ 9,44	€ 8,46	€ 9,68
06	€ 11,32	€ 11,90	€ 11,08	€ 12,44
07	€ 6,42	€ 6,74	€ 6,38	€ 7,04
08	€ 5,88	€ 6,10	€ 5,84	€ 6,50
17	€ 7,58	€ 8,46	€ 7,58	€ 8,68



TREASURE BRONZE

	SETTECENTO 08B000..	BAGUETTE 06B000..	SYNTHESIS 15B000..	OLIVIA 14B000..
01	€ 12,16	€ 12,72	€ 11,84	€ 13,08
02	€ 12,16	€ 12,72	€ 11,84	€ 13,08
03	€ 14,70	€ 15,38	€ 14,60	€ 15,96
04	€ 12,06	€ 12,72	€ 11,84	€ 13,08
05	€ 12,06	€ 12,72	€ 11,84	€ 13,08
06	€ 14,60	€ 15,18	€ 14,60	€ 15,58
07	€ 7,90	€ 8,20	€ 7,92	€ 8,56
08	€ 7,90	€ 8,10	€ 7,92	€ 8,56
17	€ 10,84	€ 11,74	€ 10,98	€ 12,08



TREASURE TITANIUM

	SETTECENTO 08C000..	BAGUETTE 06C000..	SYNTHESIS 15C000..	OLIVIA 14C000..
01	€ 12,16	€ 12,72	€ 11,84	€ 13,08
02	€ 12,16	€ 12,72	€ 11,84	€ 13,08
03	€ 14,70	€ 15,38	€ 14,60	€ 15,96
04	€ 12,06	€ 12,72	€ 11,84	€ 13,08
05	€ 12,06	€ 12,72	€ 11,84	€ 13,08
06	€ 14,60	€ 15,18	€ 14,60	€ 15,96
07	€ 7,90	€ 8,20	€ 7,92	€ 8,56
08	€ 7,90	€ 8,10	€ 7,92	€ 8,56
17	€ 10,84	€ 11,74	€ 10,98	€ 12,08



TREASURE TOTAL BLACK

SETTECENTO
1AD000..

01	€ 8,56
02	€ 8,56
03	€ 11,12
04	€ 6,56
05	€ 6,56
06	€ 9,10
07	€ 4,40
08	€ 4,20
17	€ 4,64



TREASURE INFINITO

	GOLD 19A000..	BRONZE 19B000..	TITANIUM 19C000..	TOTAL BLACK 19D000..
01	€ 9,68	€ 12,94	€ 12,94	€ 9,28
02	€ 9,68	€ 12,94	€ 12,94	€ 9,28
03	€ 10,98	€ 14,24	€ 14,24	€ 9,28
04	€ 9,58	€ 12,84	€ 12,84	€ 6,70
05	€ 9,58	€ 12,84	€ 12,84	€ 6,70
06	€ 10,66	€ 13,94	€ 13,94	€ 8,30
07	€ 7,66	€ 9,14	€ 9,14	€ 5,54
08	€ 7,04	€ 9,04	€ 9,04	€ 5,18
17	€ 8,62	€ 11,90	€ 11,90	€ 5,54
25	€ 9,68	€ 12,94	€ 12,94	€ 7,30
38	€ 9,38	€ 12,66	€ 12,66	€ 6,80
39	€ 9,34	€ 12,62	€ 12,62	€ 7,48
FB	€ 9,34	€ 12,62	€ 12,62	€ 6,76
28	€ 9,62	€ 12,88	€ 12,88	€ 6,76
29	€ 9,62	€ 12,88	€ 12,88	€ 7,62



TREASURE PALACE MARTELLATO

	HONEY 1TG000..	COPPER 1TH000..	GREY 1TI000..	TOTAL BLACK 1TD000..
01	€ 7,64	€ 7,64	€ 7,64	€ 7,64
02	€ 7,64	€ 7,64	€ 7,64	€ 7,64
03	€ 8,40	€ 8,40	€ 8,40	€ 8,40
L3	€ 7,68	€ 7,68	€ 7,68	€ 7,68
04	€ 6,92	€ 6,92	€ 6,92	€ 6,92
05	€ 6,92	€ 6,92	€ 6,92	€ 6,92
06	€ 7,58	€ 7,58	€ 7,58	€ 7,58
07	€ 4,96	€ 4,96	€ 4,96	€ 4,96
08	€ 4,76	€ 4,76	€ 4,76	€ 4,76
17	€ 5,28	€ 5,28	€ 5,28	€ 5,28



MYSTIQUE

	AUDREY 165600..	PALLADIUM 059600..	OLIVIA 049600..	SWING 088600..	MILLENIUM 227600..	BERNINI 206600..	SYNTHESIS 203600..	STRESA 032600..	TUBE 112600..	DINNER R04600..
01	5,98	€ 5,10	€ 5,10	€ 5,10	€ 5,22	€ 4,34	€ 3,92	€ 2,92	€ 2,16	€ 2,22
02	5,98	€ 5,10	€ 5,10	€ 5,10	€ 5,22	€ 4,34	€ 3,92	€ 2,92	€ 2,16	€ 2,22
03	7,54	€ 7,76	€ 7,76	€ 7,76	€ 7,76	€ 6,76	€ 6,30	€ 5,14	€ 4,14	-
L3	-	-	-	-	-	-	-	-	-	€ 2,72
04	5,78	€ 5,00	€ 5,00	€ 5,00	€ 5,12	€ 4,24	€ 3,80	€ 2,80	-	-
05	5,78	€ 5,00	€ 5,00	€ 5,00	€ 5,12	€ 4,24	€ 3,80	€ 2,80	-	-
06	7,34	€ 7,46	€ 7,46	€ 7,46	€ 7,46	€ 6,64	€ 6,20	€ 4,94	-	-
07	4,68	€ 3,16	€ 3,28	€ 3,16	€ 3,50	€ 2,84	€ 2,62	€ 1,96	€ 1,62	€ 1,62
08	4,18	€ 3,06	€ 3,28	€ 3,06	€ 3,28	€ 2,84	€ 2,62	€ 1,96	€ 1,62	-
10	-	€ 17,74	€ 19,82	€ 17,74	€ 17,74	€ 16,86	€ 17,74	€ 13,90	-	-
11	-	€ 8,74	€ 9,62	€ 8,74	€ 9,28	€ 7,86	€ 7,86	€ 6,54	-	-
12	-	€ 8,74	€ 9,62	€ 8,74	€ 9,28	€ 7,86	€ 7,86	€ 6,54	-	-
17	4,82	€ 3,96	€ 3,96	€ 3,96	€ 3,72	€ 3,06	€ 2,84	€ 2,08	€ 1,86	-
20	-	€ 12,58	€ 12,58	€ 12,58	€ 13,44	€ 12,04	€ 9,06	€ 7,52	-	-
39	5,98	€ 5,00	-	-	€ 5,10	-	-	€ 2,80	-	-



TREASURE 50/50 BLACK

	BRAMANTE 1CE000..	ELLADE 1DF000..	HERMITAGE 1FF000..
01	16,02	15,78	13,42
02	16,02	15,78	13,42
03	16,02	16,22	11,56
04	15,12	14,94	-
05	15,12	14,94	12,46
06	15,32	15,68	10,68
07	13,22	13,06	9,50
08	13,02	12,84	9,36
17	14,16	13,80	9,80
39	15,36	15,26	12,46



TREASURE TXT

	SETTECENTO GOLD 2AA000..	PALACE TITANIUM 2BC000..
01	€ 11,42	€ 14,38
02	€ 11,42	€ 14,38
03	€ 15,54	€ 18,48
04	€ 11,32	€ 14,38
05	€ 11,32	€ 14,38
06	€ 15,44	€ 18,48
07	€ 8,42	€ 9,90
08	€ 7,90	€ 9,90
17	€ 9,60	€ 12,86
39	€ 11,22	€ 14,38



FILO ORO / GOLD

	LEONARDO 050900..	BERNINI 206900..	SIRIO 226900..	AMERICA 224900..	SETTECENTO 205900..	FILET 054900..
01	€ 5,04	€ 4,08	€ 3,62	€ 3,20	€ 4,36	€ 4,26
02	€ 5,04	€ 4,08	€ 3,62	€ 3,20	€ 4,36	€ 4,26
03	€ 7,64	€ 6,40	€ 6,98	€ 5,60	€ 6,90	€ 7,56
04	€ 4,94	€ 4,08	€ 3,62	€ 3,20	€ 4,26	€ 4,26
05	€ 4,94	€ 4,08	€ 3,62	€ 3,20	€ 4,26	€ 4,26
06	€ 7,54	€ 6,40	€ 6,84	€ 5,60	€ 6,80	€ 7,56
07	€ 3,20	€ 2,74	€ 2,64	€ 2,10	€ 2,84	€ 3,28
08	€ 3,20	€ 2,74	€ 2,54	€ 2,10	€ 2,84	€ 3,16
10	€ 17,36	€ 16,26	€ 15,70	€ 15,04	€ 16,90	€ 17,36
11	€ 8,44	€ 7,36	€ 7,14	€ 6,82	€ 7,66	€ 8,08
12	€ 8,44	€ 7,36	€ 7,14	€ 6,82	€ 7,66	€ 8,08
17	€ 4,08	€ 2,98	€ 2,84	€ 2,54	€ 3,06	€ 3,48
20	€ 12,30	€ 11,52	€ 8,56	€ 8,02	€ 11,94	€ 10,56





I N D I C E

l n d e x

l n d e x

Inhaltsverzeichnis

í n d i c e

POSATE

Flatware

Aida	92	Infinito	34	Spaten	31
America	84	Ischia	88	Stile	55
Australia	93	Leonardo	50	Stresa	98
Baguette	42	Liberty	60	Superga	99
Bernini	59	Maitre	81	Swing	38
Beta	86	Millenium	52	Synthesis	72
Bramante	24	Octavia	28	Tecna	36
Brasilia	85	Olivia	40	Tema	89
Bristol	83	Palace	62	Tie	74
Byron	44	Palace Martellato	64	Touring	105
Cambridge	100	Palladium	46	Trend	70
Casali	66	Pitagora	48	Trumpet	58
Concept	32	Privilege	27	Tube	106
Dolphin	94	Punto	102	Uno	96
Eco Baguette	104	Ritz	53	Valencia	95
Ellade	25	Roma	78	Vittoriale	30
Euclide	47	Romanino	56	Wave	90
Excelsior	68	Sabrina	80		
Expo	71	Savoy	67		
Filet	79	Settecento	54		
Gamma	87	Sirio	76		
Hermitage	26	Snake	103		
Hotel	82	Solaris	75		

GLI SPECIALI - CONFEZIONI

Special flatware - packaging

Box 11+1	115	Espositori	369
Box 11+1 Trasparente	115	Etichetta Singola	116
Box 5+1	115	Forchetta Pizza	132
Chiave	114	Gli Esclusivi	119
Cartelle	114	Griglia Posate Box 11+1	112
Coltelli Bistecca	128	Griglia Posate Box 11+1 Trasparente	113
Coltelli Pizza	122	Griglia Posate C/Chiave	110
Coltello Manico Vuoto	126	Griglia Posate C/Cravatta	109
Cravatta	114	Valve	116

PRODOTTI IN ORDINE ALFABETICO

acciaino	143	coltello salmone	136-140
appendino magnetico	143	coltello servire	146
articoli gelateria	324	coltello spelucchino	134-142
bacinella pasticceria	339	coltello verdura	142
bacinelle gastronorm	225	cono cinese	258
bacinelle gn con maniglie	232	coperchio	181-187-191-198-217
bacinelle gastronorm forate	229	coperchio bagnomaria quadrato	256
bacinelle gelateria	327	coperchio gastronorm	233-234-238-246-249-251
bagnomaria	256	coperchio teglia	218-219
base per bastardella	262	coperchio zuppiera	160
bastardella	260	coppa gelato	326
batticarne	286	crepiere	212
bicchiere	301	cucchiaio marmellata	152
brocca termica	356	cucchiaio servire	154
caffettiere	333	cucchiandone multiuso	150-152-154
casseruola conica	172-179-186-187-190	cucchiandone multiuso forato	150-152
casseruola fonda	171-172-177-184-189-197-201	cucchiandone pizzaiolo	149
casseruola fonda con manico	171-178-183-190-198-202	cucchiandone risotto	146
casseruola mezza fonda - bassa	171-177-184-197-201-215	cucchiandone risotto forato	146
casser mezza fonda - bassa con manico	172-178-185-190-198-202	cucchiandone unipezzo	283
casseruola fonda con manico e maniglia	172-178-184	cuocipesce	219
cavatappi	123-286-317	distributore bevande buffet	347
cestino frutta	162	distributore succhi buffet	346
cestino pane	162	dosatore gelato	324
chaffing dish	351	falso fondo gastronorm	235-238-246-249
chiudibottiglia	320	forbici dolce	295
cloche	158-160-275-276	forchetta 5 punte	146
colapasta	186-257	forchetta servire	154
colapasta sferico	257	forchettone 3 punte	149
coltello affettati	134-139	forchettone arrosto	120-140
coltello bistecca	119-128-130-142	forchettone insalata	150-151
coltello cucina	135-138-139-140	forchettone unipezzo	282-283
coltello cucina orientale	138	forma creme caramel	263
coltello disossatore	134-139	formaggera	166
coltello pane	124-135-139	fruste	284
coltello per filettare	134-139	imbuto	263
coltello prosciutto	135-140	insalatiera	260
		lattiera	333
		legumiera con alette	310
		lumachiera	220

manaretta	138	salsiere	274
mattarello	263	scaldapasta forato	258
mestolo unipezzo	280	scaldapasta settori	258
mestolo salsa unipezzo	281	scavino crostacei	133
mezzaluna	143	schiumarola unipezzo	280
molle	288-290-292	scodelle	309-311
morsa prosciutto	350	secchiello champagne	163
multiuso crostacei	133	secchiello ghiaccio	163
oliera	164-167	separatore	235
padella 173-179-185-190-199-202-205-207-209-		setacci	259
	211-216	shaker	315
padella sauté	173-192	sottobicchiere	157
padella sauté antiaderente	173-192	sottobottiglia	157
paellera girevole	355	sottopiatto	157-158
paiolo	216	spatola gelato	324-325
pala fritto unipezzo	281-283	spatola unipezzo	281
pala lasagne	120-147	speedy-pasta	193
pala torta	147-296	spillone porta scontrini	316
pala uovo	147	spremiagrumi	316
passabrodo	258	tappo champagne	320
passaverdura	262	tappo vino	320
pentola	177-183-189-195-197	tazza brodo	309
piattino cassata	326	tegame	179-180-185-191-201-211-215- 220
piattino per coppa	326	tegame antiaderente	180
piatto affettati buffet	349	tegame uovo	220
piatto fondo	308	teglia gastronorm	228-231-245
piatto formaggi buffet	343	teglia gastronorm alluminio antiad.	228
piatto ovale	266	teglie	218-219-228-231-245
piatto piano	308	teiera	333-334
piatto portapane	158	trinciapollo	120-286-305
pietanziera	308	utensili cucina ellisse	314-318
pinza aragosta	133	vassoi bar	270-318-319
porta brocche	356	vassoi con scomparti	235-310
porta burro	275-348	vassoi impilabili	338
porta burro buffet	360	vassoio gratin	267
portagrissini	162	vassoio ovale	161-271
portapane buffet	344	vassoio rettangolare	268-272-319
posate detenuti	311	vassoio rettangolare pasticceria	338-339
punta grana	143	vassoio tondo	161-267-269-271-319-337
raccogli briciole	286	wok	187-212
ricambi	360	wok con 1 manico	212
roll up	173-192	zuccheriera	317
rompinoci	286	zuppiera	160-274-276
sale pepe	164-167		

ALL ITEMS AVAILABLE

3 prong fork	149	deep plate	308
5 prong fork	146	display	369
bain marie	256	divider	235
basin with retractable handles	232	drink dispenser	346-347
bar tray	270-318-319	edged oval tray	266
bill spike	316	edged plate	326
boning knife	134-139	egg lifter	147
bottle coaster	157	false perforated bottom	235-238-246-249
bottle stopper	320	fillet knife	134-139
bowl	309-311	fishkettle	219
bread basket	162	flat plate	308
bread coaster	158	foot for semispheric bowl	262
bread stick holder	162	french omelet pan	220
bread knife	124-135-139	fruit basket	162
butcher's knife	136-138	frying pan	173-179-185-190-199-202-205- 207-209-211-216
butter dish	275-348	frying pan 2 handles	179-180-185-191-201-211- 215-220
butter tray	360	funnel	263
cake server	147-296	glass	309
carving fork	120-140	gratin tray	267
chafing dishes	351	ham clamp	350
champagne bucket	163	ham slicer	135-140
champagne stopper	320	ice bucket	163
cheese bowl	166	ice cream scoop	324
chef knife	135-138-139-140	ice cream plate	326
chinois	258	ice cream spatula	324-325
citrus squeezer	316	jam/honey spoon	152
cleaver	138	japanese cook	138
cloche	158-160-275-276	jug holder	356
coaster	157	juice dispenser	346
coffee pot	333	ladle Unipezzo	280
colander	186-257	lid	181-187-191-198-217
conical casserole	172-179-186-187-190	lid for roasting pan	218
conical ice cream goblet	326	lid for soup bowl	160
convict spoon and fork	311	lid gastronorm	233-234-238-246-249-251
cork screw	123-286-317	lobster cracker	121-133
creme caramel mould	263	lobster pick	121-133
crepe frying pan	212	low casserole	171-177-184-197-201-215
cruet	164-167	meat mallet	286
crumb collector	286	mincing knife	143
deep casserole	171-172-177-184-189-197- 201		

multipurpose spoon	154	saucepan	172-178-184
non stick frying pan 2 handles	180		
non stick sauté pan	173-192	soup bowl	160-274-276
non stick basin	228	soup cup	309
nutcracker	286	spatula lasagne	147
paellera	355	spatula unipezzo	281
paring knife	134-142	Speedy-Pasta	193
parmesan cheese knife	143	spherical colander	257
pastry deep tray	338-339	square lid	256
peeling knife	142	spare parts	360
perforated rice spoon	146	stackable basin	225-229-236-240-243--247- 250
perforated spatula Unipezzo	281	steak knife	119-128-130-142
perforated spoon	150-152	strainer	258-259
perforated stackable basin	229-243	sugar bowl	317
pitcher	356	tea pot	333-334
pot	177-183-189-195-197	tomato spoon	149
poultry shears	120-286-305	tong	288-290-292
rectangular tray	268-272-319	tray for cheese buffet	343
rice spoon	146	tray with sector	235-310
roasting pan	218-219	underplate	157-158
roll up	173-192	utensils ellisse	314-318
round edged tray	267-269	vegetable dish with handles	310
round tray	161-267-269-271-319-337	vegetable mill	262
salad bowl with handles	260	wall tray for sliced	349
salad fork	150-151	warmer	355
salmon knife	136-140	whisk	284
salt and pepper	165-167	wine stopper	320
sauce boat	160-274-276	wok	187-212
sauce ladle Unipezzo	281		
sauté frying pan	173-192		
sea food pick	133		
section colander	258		
separator	235		
serving dish	308		
serving fork	150-151-154		
serving fork unipezzo	282-283		
serving knife	122-146		
serving spoon	147-150-151-154		
serving spoon unipezzo	282-283		
shaker	315		
sharpener	143		
skimmer unipezzo	280		
slicer knife	134-139		
snails plate	220		

PINTINOX

HO

RE

CA

2020