

IL SOLE È
NUOVO
OGNI
GIORNO

THE SUN IS
NEW EVERY
DAY

DESIGN COLLECTION 2022

OV
ombrellificio®
veneto by Doro

**IL SOLE È NUOVO
OGNI GIORNO**

**THE SUN IS NEW
EVERY DAY**

OV
ombrellificio®
veneto by Doro

**DESIGN
COLLECTION
2022**

ombrellificio veneto

**DA OLTRE 30 ANNI
LEADER NELLA PRODUZIONE
DI OMBRELLONI**

**FOR OVER 30 YEARS
LEADER IN PRODUCTION
OF PARASOLS**

Ombrellificio Veneto è un'azienda che dal 1983 produce ombrelloni da giardino e da bar/ristorante, ombrelloni pubblicitari e fioriere, in alluminio e legno. La vasta gamma di prodotti, la cura nei dettagli tipica della migliore tradizione artigiana, la professionalità e la tecnologia usata nei sistemi di produzione, unite ad un design elegante e raffinato, fanno della nostra azienda una garanzia per la clientela più varia ed esigente nel settore dell'arredo per esterni.

Since 1983 Ombrellificio Veneto it's an italian firm that produces garden/bar/restaurant parasols, advertising parasols and flower boxes, in aluminium and wood. The wide range of products, the care in details typical of the best artisan tradition, the professionalism and technology used in the production systems, together with an elegant and refined design, make our firm as a reference point and a warrant for the most diverse and particular clientele in the outdoor - life style sector.

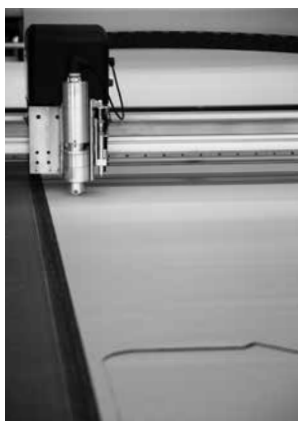

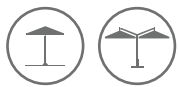





9

OMBRELLONI A PALO CENTRALE GIGANTI E MULTIPLI

GIANT CENTRAL POLE AND MULTIPLE PARASOLS

LEONARDO 10

GALILEO 14

FELLINI 18



23

OMBRELLONI A BRACCIO LATERALE

LATERAL ARM PARASOLS

SATURNO 24

VESPUCCI 28

VENERE 32

AFRODITE 36

MARTE 38

RIVIERA 42

HORIZON 46

FLAT 50

MURALES 54

ETERNITY 58

PITAGORA 62

ECLISSE 66



71

**OMBRELLONI
A PALO
CENTRALE**

**CENTRAL POLE
PARASOLS**

99

**MEZZI
OMBRELLONI**

**HALF
PARASOLS**

DOLOMITI ALLUMINIO 72

DOLOMITI LEGNO 76

PETRARCA ALLUMINIO 80

PETRARCA LEGNO 84

OCEAN ALLUMINIO 88

OCEAN LEGNO 92

LAGUNA 94

CITY 100



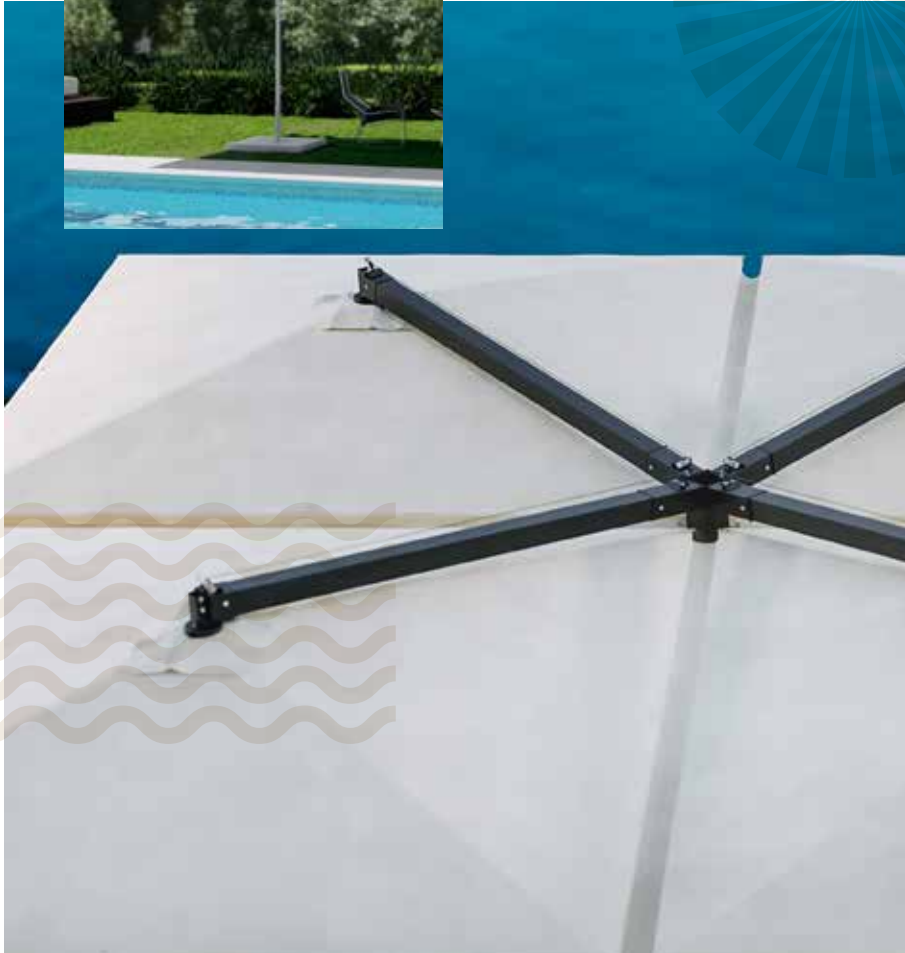

OMBRELLONI A PALO CENTRALE GIGANTI E MULTIPLI

GIANT CENTRAL POLE AND MULTIPLE PARASOLS



LEONARDO	10
----------	----

GALILEO	14
---------	----

FELLINI	18
---------	----







LEONARDO

ombrellone
a palo centrale
in alluminio
aluminium central
pole parasol

- chiusura telescopica sopra i tavoli
- svariate misure, da 3x5 fino a 7x7
- base optional
- versione standard con pendente
- telescopic system for closing over the tables below
- several sizes since 3x5 until 7x7
- optional base
- standard version with flounce

scheda tecnica
data sheet
pag. 104





- versione standard con pendente
- dispositivo chiusura telescopica sopra i tavoli brevettata (escluso 6x6)
- di serie completo di 4 canaline

- standard version with flounce
- patented telescopic system for closing over the tables below (not 6x6)
- standard with 4 gutters

scheda tecnica
data sheet
pag. 106



GALILEO

ombrellone multiplo
telescopico in alluminio
multiple telescopic
parasol in aluminium











FELLINI

ombrellone multiplo
telescopico in alluminio
multiple telescopic
parasol in aluminium

- disponibile in versione a "V" e a "T"
- di serie completo di canalina
- versione standard con pendente
- available in "V" and "T" versions
- standard with gutter
- standard version with flounce

scheda tecnica
data sheet
pag. 107







OMBRELLONI A BRACCIO LATERALE

LATERAL ARM PARASOLS

SATURNO 24

VESPUCCI 28

VENERE 32

AFRODITE 36

MARTE 38

RIVIERA 42

HORIZON 46

FLAT 50

MURALES 54

ETERNITY 58

PITAGORA 62

ECLISSE 66



- girevole 360°
- sezione pali 9.2x9.2
- 360° rotating
- section poles 9.2x9.2

scheda tecnica
data sheet

pag. 108

360°



SATURNO

ombrellone a braccio
laterale in alluminio
aluminium lateral
arm parasol







VESPUCCI

ombrellone a braccio
laterale in legno
wooden lateral
arm parasol

- girevole 360°
- sezione pali 9.2x9.2
- 360° rotating
- section poles 9.2x9.2

scheda tecnica
data sheet
pag. 109







VENERE

ombrellone a braccio laterale
in alluminio verniciato grigio
antracite

aluminium lateral arm parasol
anthracite varnished

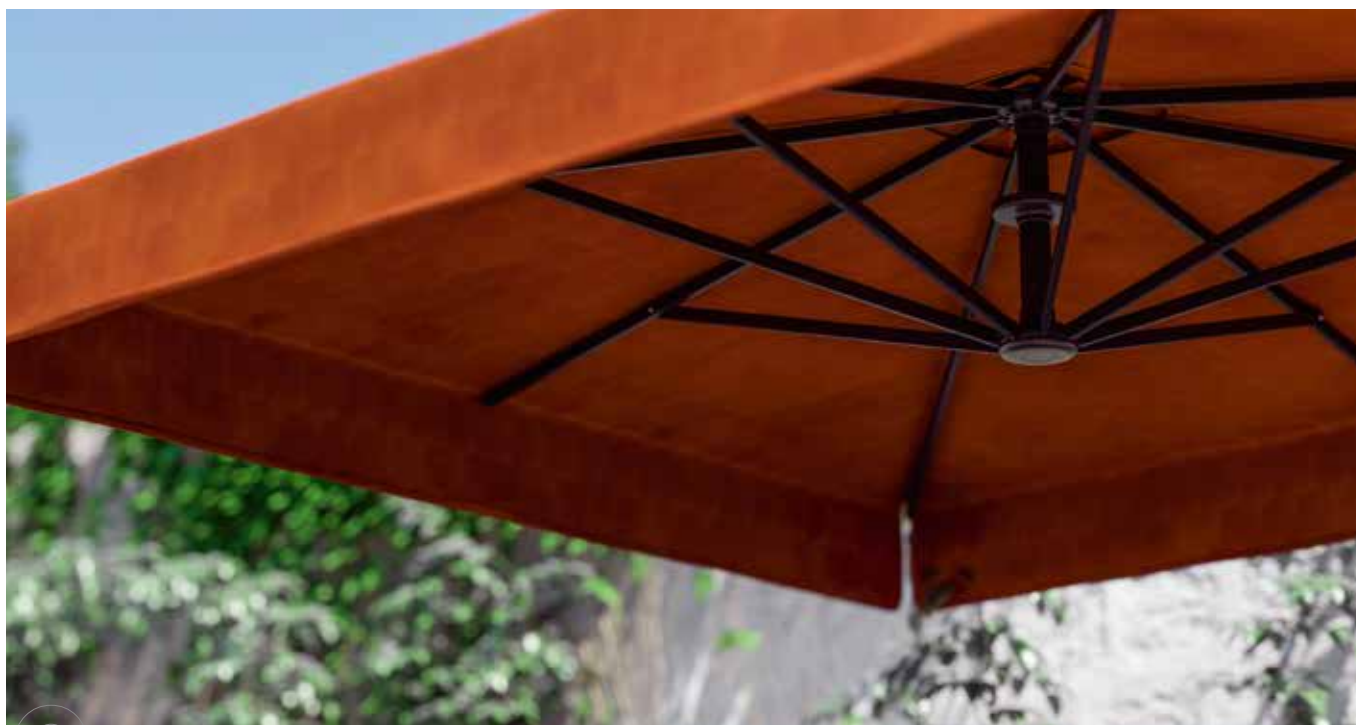

360

- girevole 360°
- sezione pali 7.2x7.2

360

- 360° rotating
- section poles
- 7.2x7.2

scheda tecnica
data sheet
pag. 110











AFRODITE

ombrellone a braccio laterale
in alluminio verniciato bianco
aluminium lateral arm parasol
white varnished

360°
360°

- girevole 360°
- versione standard con pendente
- 360° rotating
- standard version with flounce

scheda tecnica
data sheet
pag. 111



MARTE

ombrellone a braccio laterale in
alluminio verniciato tortora
aluminium lateral arm
parasol dove grey varnished

- girevole 360°
- possibilità di
fissaggio al suolo
- 360° rotating
- possibility of fixing
on the ground

scheda tecnica
data sheet
pag. 112

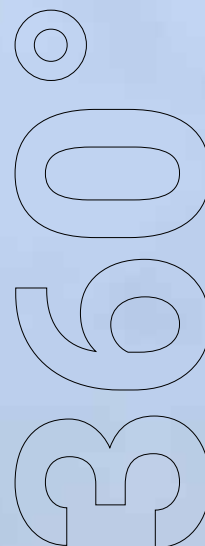





- girevole 360°
- sezione pali 7.2x7.2
- 360° rotating
- section poles 7.2x7.2

scheda tecnica
data sheet
pag. 113

360°



RIVIERA

ombrellone a braccio laterale
in legno
wooden lateral arm parasol







HORIZON

ombrellone a braccio
laterale orientabile
in alluminio verniciato
grigio antracite

aluminium lateral
orientable arm parasol
anthracite varnished

- orientabile a dx e a sx
- girevole 360°
- orientable right and left
- 360° rotating

scheda tecnica
data sheet
pag. 114

360







- apertura e chiusura a ventaglio
- orientabile a dx e a sx
- fan shaped opening and closing
- orientable right and left

scheda tecnica
data sheet
pag. 115

360°



FLAT

ombrellone a braccio laterale
a ventaglio in alluminio

fan shaped aluminium lateral arm
parasol







MURALES

ombrellone a braccio laterale
addossato in alluminio verniciato
grigio antracite

lateral arm parasol attached to
the wall in aluminium anthracite
grey

- possibilità di
posizionamento
alla parete di
aggancio
- predisposizione per
aggancio tramite
tirante
- placement attached
to the wall
- prepared for
docking by cable

scheda tecnica
data sheet
pag. 116









ETERNITY

ombrellone a braccio
laterale in alluminio

lateral arm parasol
in aluminium

- gambone, tubo girevole e angoli zincati a caldo
- stecche intercambiabili, sezione 2,0x3,5
- hot galvanized leg, rotation tube and angle
- interchangeable ribs, section 2,0x3,5

scheda tecnica
data sheet
pag. 117









PITAGORA

ombrellone a braccio laterale
retrattile in alluminio
verniciato grigio antracite e bianco
retractable aluminium lateral
arm parasol anthracite and white
varnished

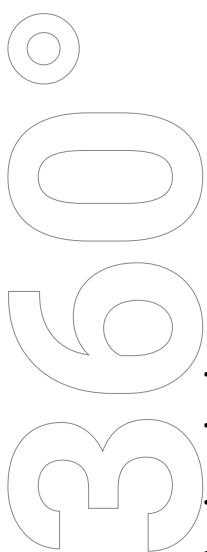

- sistema di chiusura retrattile
- versione standard con pendente
- retractable closing system
- standard version with flounce
- scheda tecnica data sheet
- pag. 118







ECLISSE

ombrellone a braccio
laterale in alluminio
verniciato grigio antracite
aluminium lateral arm
parasol anthracite varnished



- dispositivo sollevamento
telescopico brevettato per
chiusura ombrellone (solo
su 5x5)
- base optional
- patented telescopic lifting
system for parasol closing
(only on 5x5)
- optional base

scheda tecnica
data sheet
pag. 119









OMBRELLONI A PALO CENTRALE

CENTRAL POLE PARASOLS

DOLOMITI ALLUMINIO 72

DOLOMITI LEGNO 76

PETRARCA ALLUMINIO 80

PETRARCA LEGNO 84

OCEAN ALLUMINIO 88

OCEAN LEGNO 92

LAGUNA 94



DOLOMITI ALLUMINIO

ombrellone a palo centrale
in alluminio
aluminium central
pole parasol

- possibilità di fissaggio al suolo
- palo Ø 60
- possibility of fixing on the ground
- Ø 60 pole

scheda tecnica
data sheet
pag. 120













DOLOMITI LEGNO

ombrellone
a palo centrale
in legno

wooden central
pole parasol

- possibilità di fissaggio al suolo
- anche tinta Iroko
- possibility of fixing on the ground
- also iroko colour

scheda tecnica
data sheet
pag. 121





PETRARCA ALLUMINIO

ombrellone a palo centrale
telescopico in alluminio
telescopic aluminium
central pole parasol



- chiusura telescopica sopra i tavoli
- palo Ø 60
- telescopic system for closing over the tables below
- Ø 60 pole

scheda tecnica
data sheet
pag. 122







PETRARCA LEGNO

ombrellone a palo centrale
telescopico in legno
telescopic wooden central
pole parasol



- chiusura
telescopica sui
tavoli
- possibilità di
fissaggio al suolo
- telescopic system
for closing over the
tables below
- possibility of fixing
on the ground

scheda tecnica
data sheet
pag. 123







OCEAN ALLUMINIO

ombrellone a palo centrale
in alluminio
aluminium central
pole parasol

- apertura a sollevamento, senza carrucole
- opening system by lifting, without pulleys

scheda tecnica
data sheet
pag. 124







OCEAN LEGNO

ombrellone a palo centrale
in legno
wooden central pole parasol





LAGUNA

ombrellone a palo centrale
in legno

wooden central pole parasol

- possibilità di
fissaggio al suolo
- possibility of fixing
on the ground

scheda tecnica
data sheet
pag. 125











MEZZI OMBRELLONI

HALF PARASOLS

CITY

100



CITY

mezzo ombrellone
in alluminio verniciato
grigio antracite
aluminium anthracite grey
varnished half-parasol

- versione standard
con pendente
- possibilità di
fissaggio al suolo e
a muro
- standard version
with flounce
- possibility of fixing
on the ground/to
the wall

scheda tecnica
data sheet
pag. 126







SCHEDE TECNICHE

TECHNICAL SHEET

leonardo	104
galileo	106
fellini	107
saturno	108
vespucci	109
venere	110
afrodite	111
marte	112
riviera	113
horizon	114
flat	115
murales	116
eternity	117
pitagora	118
eclisse	119
dolomiti alluminio	120
dolomiti legno	121
petrarca alluminio	122
petrarca legno	123
ocean	124
laguna	125
city	126

ACCESSORI OPTIONALS 128

TESSUTI FABRICS 129

leonardo

ombrellone
a palo centrale
in alluminio
aluminium central
pole parasol





CARATTERISTICHE TECNICHE TECHNICAL DATA

possibilità di fissaggio al suolo
possibility of fixing on the ground
ombrellone standard fornito
con pendente
standard version with frounce
stecche intercambiabili e rinforzate
interchangeable and reinforced ribs

parti metalliche prima zincate,
poi verniciate
metal parts galvanized and
varnished

sistema a doppio ragno
che consente la chiusura sopra
i tavoli sottostanti
telescopic system for closing
over the tables below

COLORI STRUTTURA FRAME COLOURS

-  grigio antracite
anthracite grey
-  bianco
white

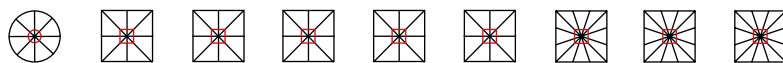
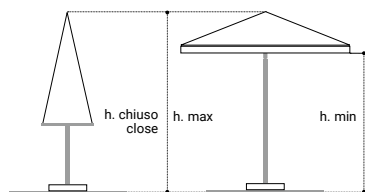
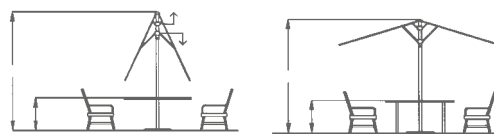

DIMENSIONE / SIZE	Ø8	4x4	4,5x4,5	5x5	5,5x5,5	6x6	6x6	6,5x6,5	7x7
ALTEZZA CHIUSO CON BASE (CM) HEIGHT CLOSED	505		440	464	505	521	533	545	605
ALTEZZA APERTO CON BASE HEIGHT OPENED WITH BASE									
VOLUME IMBALLO m³ / PACKED VOLUME	0,75		0,46	0,48	0,52	0,53	0,53	0,55	0,60
PALO / POLE	10	10	10	10	10	10	10	10	10
STECHE (NR./DIM.) / RIBS/SIZES	8 20x35	8 20x35	8 20x35	8 20x35	8 20x35	8 20x35 20x40	12 20x35 20x40	12 20x35 20x40	12 20x35 20x40
PENDENTE / FLOUNCE
TESSUTO / FABRIC									
Acrilico - Tempotest® Parà Ombrelloni Tempotest® Parà Starlight Blue - PVC Acrylic - Tempotest® Parà Parasols Tempotest® Parà Starlight Blue - PVC



OPTIONALS

base: 106,5x106,5 cm

base: 106,5x106,5 cm

carter copribase

coverbase carter

finitura pendente:

flounce finishing:



merletti
crenelation



onde
wave

Impianto luci

a led bianche naturali

con telecomando (a luce

calda su richiesta)

natural white led lighting

system with remote control

(on demand 3000 K°)

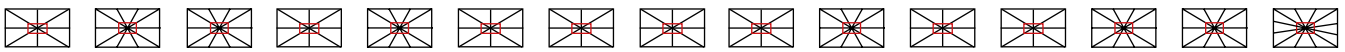
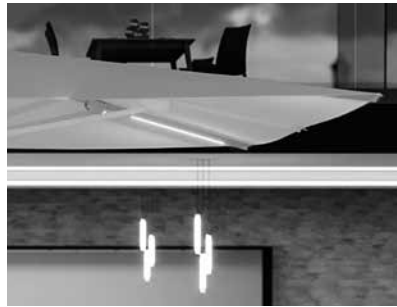
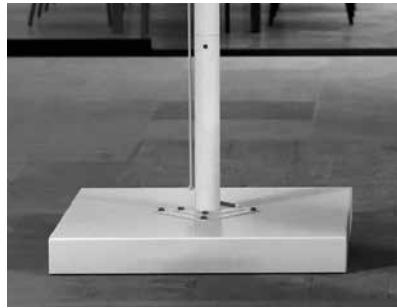

3x5	3x6	3x7	3,5x5	3,5x7	4x4,5	4x5	4,5x5,5	4x6	4x7	5x6	5x7	5x7	6x7	6x7
433	448	448	433	495		430	473	480	507	505	513	531	566	
328	326	338	328	351		320	340	340	371	352	369	381	392	
	201	220	213	215		210	225	230	234	227	233	247	268	
			0,46			0,46	0,39	0,49	0,52	0,52	0,53	0,53	0,56	
10	10	10	10	10	10	10	10	10	10	10	10	10	10	10
8	10	10	8	10	8	8	8	8	10	8	8	10	10	12
20x35	20x35 20x40	20x35 20x40	20x35	20x35 20x40	20x35	20x35	20x35	20x35	20x35 20x40	20x35	20x35 20x40	20x35 20x40	20x35 20x40	20x35 20x40
.
.

galileo

ombrellone multiplo
telescopico in alluminio
multiple telescopic
parasol in aluminium





CARATTERISTICHE TECNICHE TECHNICAL DATA

possibilità di fissaggio al suolo
possibility of fixing on the ground
ombrellone standard fornito
con pendente
standard version with flounce
stecche intercambiabili
interchangeable ribs
con stecche antivento tra palo
verticale e ragni
anti-wind ribs between
vertical pole and frames
stecche angolari 8x8 rinforzate
reinforced angular ribs for 8x8

base maggiorata per
le misure 7x7 e 8x8
big base for size 7x7 e 8x8
di serie completo di 4 canaline
standard with 4 gutters
parti metalliche prima zincate,
poi verniciate
metal parts galvanized and
varnished
dispositivo sollevamento
telescopico
brevettato (escluso 6x6)
patented telescopic lifting
system (not 6x6)

COLORI STRUTTURA FRAME COLOURS

 grigio antracite
anthracite grey
 bianco
white

OPTIONALS

carter copribase
coverbase carter
finitura pendente:
flounce finishing:

 merletti
crenelation

 onde
wave

impianto luci
a led bianche naturali
(a luce calda su richiesta)
natural white led lighting
system (on demand 3000 K°)

DIMENSIONE / SIZE		6x6	7x7	8x8
A	ALTEZZA - TELESCOPIO SU HEIGHT - TELESCOPE UP	h. max (cm) 240	h. max (cm) 304	h. max (cm) 321
	ALTEZZA - TELESCOPIO GIÙ HEIGHT - TELESCOPE DOWN	h. min (cm) 240	h. min (cm) 254	h. min (cm) 271
DIMENSIONE EFFETTIVA REAL SIZE		605x605	715x715	815x815
VOLUME IMBALLO m ³ PACKED VOLUME m ³		0,86	1,08	1,17
COLONNA VERTICALE VERTICAL COLUMN		11,2x11,2	11,2x11,2	11,2x11,2
PALI SUPERIORI (cm) UPPER POLES		9,2x9,2	9,2x9,2	9,2x9,2
STECHE (NR.) / RIBS		8x4	8x4	8x4
PENDENTE / FLOUNCE		•	•	•
TESSUTO / FABRIC Acrilico - Tempotest® Parà Ombrelloni - PVC Acrylic - Tempotest® Parà Parasols - PVC		•	•	•

fellini

ombrellone multiplo
in alluminio
multiple parasol
in aluminium



CARATTERISTICHE TECNICHE TECHNICAL DATA

possibilità di fissaggio al suolo
possibility of fixing on the ground
stecche intercambiabili
interchangeable ribs
con stecche antivento tra palo
verticale e ragni
anti-wind ribs between vertical pole
and frames
stecche angolari 4x8 rinforzate
reinforced angular
ribs for 4x8
di serie completo di canalina
standard with gutter

parti metalliche prima zincate,
poi verniciate
metal parts galvanized and
varnished
base maggiorata per le misure
3,5x7 a "V" e 4x8 a "V"
big base for sizes 3,5x7 "V"
and 4x8 "V"



COLORI STRUTTURA FRAME COLOURS

● grigio antracite
anthracite grey
○ bianco
white









OPTIONALS

carter copribase
coverbase carter
finitura pendente:
flounce finishing:

 merletti
crenelation

 onde
wave

impianto luci a led
bianche naturali
(a luce calda su richiesta)
natural white led lighting
system (on demand 3000 K°)

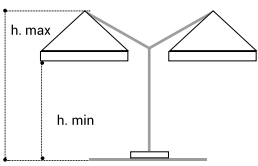
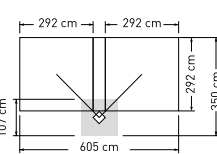
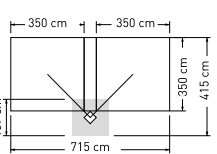
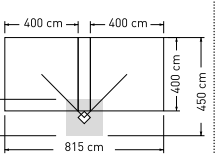
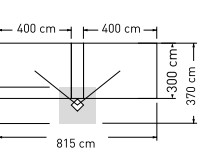
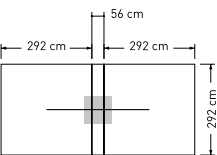
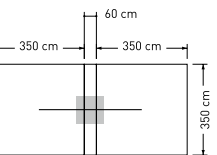
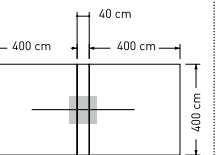
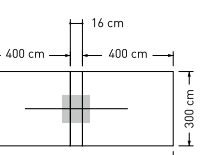
"V" VERSION					
"T" VERSION					
DIMENSIONE / SIZE	3x6	3,5x7	4x8	3x8	
	h. max (cm)	324	348"V"-336"T"	386"V"-374"T"	330
	h. min. (cm)	240	254"V"-242"T"	271"V"-259"T"	235
"V" VERSION					
"T" VERSION					
COLONNA VERTICALE VERTICAL COLUMN	11,2x11,2	11,2x11,2	11,2x11,2	11,2x11,2	
PALI SUPERIORI (cm) UPPER POLES	9,2x9,2	9,2x9,2	9,2x9,2	9,2x9,2	
STECHE (NR.) / RIBS	8x2	8x2	8x2	8x2	
PENDENTE / FLOUNCE	•	•	•	•	
TESSUTO / FABRIC Acrilico - Tempotest® Parà Ombrelloni - PVC Acrylic - Tempotest® Parà Parasols - PVC	•	•	•	•	

saturno

ombrellone a braccio
laterale in alluminio
aluminium lateral
arm parasol



CARATTERISTICHE TECNICHE TECHNICAL DATA

possibilità di fissaggio al suolo
possibility of fixing on the ground

parti metalliche prima zincate,
poi verniciate
metal parts galvanized and
varnished

con stecca antivento tra palo
verticale e ragno
anti-wind rib between vertical
pole and frame

stecche intercambiabili
interchangeable ribs

stecche diagonali 4x4 rinforzate
reinforced diagonal ribs for 4x4

girevole 360°
360° rotating

ombrellone standard fornito
con pendente
standard version with flounce

COLORI STRUTTURA FRAME COLOURS

 grigio antracite
anthracite grey

 bianco
white

OPTIONALS

carter copribase

coverbase carter

finitura pendente:

flounce finishing:

 merletti
crenelation

 onde
wave

*impianto luci a led bianche
(a luce calda su richiesta)
natural white led lighting
system (on demand 3000 K°)*

*fioriera in alluminio
aluminium planter*

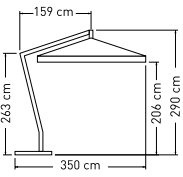
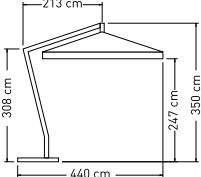
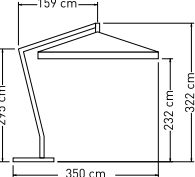

DIMENSIONE / SIZE	3x3	4x4	3x4
			
PALO (cm) / POLE	9,2x9,2	9,2x9,2	9,2x9,2
STECHE (NR.) / RIBS	8	8	8
PENDENTE / FLOUNCE	•	•	•
TESSUTO / FABRIC	•	•	•
Acrilico - Tempotest® Parà Ombrelloni - PVC Acrylic - Tempotest® Parà Parasols - PVC			

vespucci

ombrellone a braccio
laterale in legno
wooden lateral
arm parasol



CARATTERISTICHE TECNICHE TECHNICAL DATA

possibilità di fissaggio al suolo
possibility of fixing on the ground

parti metalliche prima zincate,
poi verniciate
metal parts galvanized
and varnished

con stecca antivento tra palo
verticale e ragno
anti-wind rib between vertical pole
and frame

girevole 360°
360° rotating

OPTIONALS

carter copribase
coverbase carter

finitura pendente:
flounce finishing:

 merletti
crenelation

 onde
wave

impianto luci a led bianche
(a luce calda su richiesta)
natural white led lighting system
(on demand 3000 K°)

fioriera in legno
wooden planter

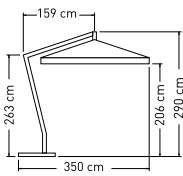
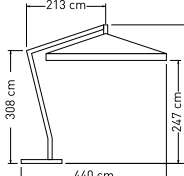
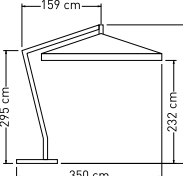

DIMENSIONE / SIZE	3x3	4x4	3x4
			
PALO (cm) / POLE	9,2x9,2	9,2x9,2	9,2x9,2
STECHE (NR.) / RIBS	8	8	8
PENDENTE / FLOUNCE	•	•	•
TESSUTO / FABRIC	•	•	•
Acrilico - Tempotest® Parà Ombrelloni - PVC Acrylic - Tempotest® Parà Parasols - PVC	•	•	•

venere

ombrellone a braccio
laterale in alluminio
verniciato grigio antracite
aluminium lateral
arm parasol anthracite
varnished



CARATTERISTICHE TECNICHE TECHNICAL DATA

possibilità di fissaggio al suolo
possibility of fixing on the ground
parti metalliche prima zincate,
poi verniciate
metal parts galvanized and varnished
con stecca antivento tra palo
verticale e ragno
anti-wind rib between vertical
pole and frame
stecche intercambiabili
interchangeable ribs
girevole 360°
360° rotating

OPTIONALS

carter copribase
coverbase carter

finitura pendente:
flounce finishing:



merletti
crenelation



onde
wave

impianto luci a led bianche
(a luce calda su richiesta)
natural white led lighting
system (on demand 3000 K°)

fioriera in alluminio
aluminium planter



DIMENSIONE / SIZE	2x2	2,5x2,5	3x3	2x3	3x4
PALO (cm) / POLE	7,2x7,2	7,2x7,2	7,2x7,2	7,2x7,2	7,2x7,2
STECHE (NR.) / RIBS	5	5	8	6	8
PENDENTE / FLOUNCE	•	•	•	•	•
TESSUTO / FABRIC Acrilico - Tempotest® Parà Ombrelloni - PVC Acrylic - Tempotest® Parà Parasols - PVC	•	•	•	•	•

afrodite

ombrellone a braccio
laterale in alluminio
verniciato bianco
aluminium lateral arm
parasol white varnished



CARATTERISTICHE TECNICHE TECHNICAL DATA

possibilità di fissaggio al suolo
possibility of fixing on the ground
parti metalliche prima zincate,
poi verniciate
metal parts galvanized
and varnished
con stecca antivento tra palo
verticale e ragno
anti-wind rib between vertical
pole and frame
stecche intercambiabili
interchangeable ribs
girevole 360°
360° rotating
ombrellone standard
fornito con pendente
standard version
with frounce

OPTIONALS

carter copribase

coverbase carter

finitura pendente:

frounce finishing:



merletti
crenelation



onde
wave

*impianto luci a led bianche
(a luce calda su richiesta)
natural white led lighting
system (on demand 3000 K°)*

*fioriera in alluminio
aluminium planter*



DIMENSIONE / SIZE	3x3	2x3	3x4
PALO (cm) / POLE	7,2x7,2	7,2x7,2	7,2x7,2
STECHE (NR.) / RIBS	8	6	8
PENDENTE / FLOWNCE	•	•	•
TESSUTO / FABRIC Acrilico - Tempotest® Parà Ombrelloni - PVC Acrylic - Tempotest® Parà Parasols - PVC	•	•	•

marTE

ombrellone a braccio
laterale in alluminio
verniciato tortora
aluminium lateral arm
parasol dove grey
varnished



CARATTERISTICHE TECNICHE TECHNICAL DATA

possibilità di fissaggio al suolo
possibility of fixing on the ground
parti metalliche prima zincate,
poi verniciate
metal parts galvanized and varnished
con stecca antivento tra palo
verticale e ragno
anti-wind rib between vertical
pole and frame
stecche intercambiabili
interchangeable ribs
ombrellone standard fornito
senza pendente
standard version without flounce
girevole 360°
360° rotating

OPTIONALS

carter copribase

coverbase carter

finitura pendente:

flounce finishing:



merletti
crenelation



onde
wave

impianto luci a led bianche

(a luce calda su richiesta)

*natural white led lighting
system (on demand 3000 K°)*

fioriera in alluminio

aluminium planter



DIMENSIONE / SIZE	3x3	2x3	3x4
PALO (cm) / POLE	7,2x7,2	7,2x7,2	7,2x7,2
STECHE (NR.) / RIBS	8	6	8
TESSUTO / FABRIC Acrilico - Tempotest® Parà Ombrelloni - PVC Acrylic - Tempotest® Parà Parasols - PVC	•	•	•

riviera

ombrellone a braccio
laterale in legno
wooden lateral
arm parasol



CARATTERISTICHE TECNICHE TECHNICAL DATA

possibilità di fissaggio al suolo
possibility of fixing on the ground

parti metalliche prima zincate,
poi verniciate
metal parts galvanized and
varnished

con stecca antivento tra palo
verticale e ragno
anti-wind rib between vertical pole
and frame

girevole 360°
360° rotating

OPTIONALS

carter copribase
coverbase carter

finitura pendente:
flounce finishing:



merletti
crenelation



onde
wave

impianto luci a led bianche
(a luce calda su richiesta)
natural white led lighting
system (on demand 3000 K°)

fioriera in legno
wooden planter



DIMENSIONE / SIZE	3x3	2x3	3x4
PALO (cm) / POLE	7,2x7,2	7,2x7,2	7,2x7,2
STECHE (NR.) / RIBS	8	6	8
PENDENTE / FLOUNCE	•	•	•
TESSUTO / FABRIC	•	•	•
Acrylic - Tempotest® Parà Ombrelloni - PVC Acrylic - Tempotest® Parà Parasols - PVC			

horizon

ombrellone a braccio
laterale orientabile
in alluminio verniciato
grigio antracite
aluminium lateral
orientable arm parasol
anthracite varnished



CARATTERISTICHE TECNICHE TECHNICAL DATA

possibilità di fissaggio al suolo
possibility of fixing on the ground
parti metalliche prima zincate,
poi verniciate
metal parts galvanized and varnished
con stecca antivento tra palo
verticale e ragno
anti-wind rib between vertical
pole and frame
stecche intercambiabili
interchangeable ribs
ombrellone standard fornito
senza pendente
standard version without flounce
girevole 360°
360° rotating

OPTIONALS

carter copribase
coverbase carter
finitura pendente:
flounce finishing:

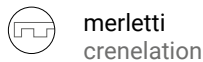

impianto luci a led bianche
(a luce calda su richiesta)
natural white led lighting
system (on demand 3000 K°)
fioriera in alluminio
aluminium planter

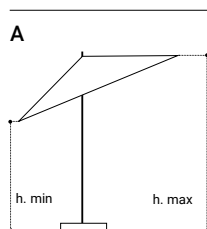

DIMENSIONE / SIZE

DIMENSIONE / SIZE		3x3	2x3	3x4
A	h. max (cm)	290	286	320
	h. min. (cm)	180	190	155
PALO (cm) / POLE		7,2x7,2	7,2x7,2	7,2x7,2
STECHE (NR.) / RIBS		8	6	8
TESSUTO / FABRIC Acrylic - Tempotest® Parà Ombrelloni - PVC Acrylic - Tempotest® Parà Parasols - PVC		•	•	•

flat

ombrellone a braccio
laterale a ventaglio
in alluminio
fan shaped aluminium
lateral arm parasol



CARATTERISTICHE TECNICHE TECHNICAL DATA

apertura e chiusura a ventaglio
con calamite e velcro
fan shaped opening and closing
with magnets and velcro
possibilità di fissaggio al suolo
possibility of fixing on the ground
parti metalliche prima zincate,
poi verniciate
metal parts galvanized and varnished

stecche intercambiabili
interchangeable ribs

ombrellone standard fornito
senza pendente
standard version
without flounce
girevole 360°
360° rotating



orientabile a dx e a sx
orientable right and left

COLORI STRUTTURA FRAME COLOURS

● grigio antracite
anthracite grey
○ bianco
white

OPTIONALS

carter copribase
coverbase carter
fioriera in alluminio
aluminium planter

1



2



3



4



DIMENSIONE / SIZE	2,5x2,5	2,8x2,8
PALO (cm) / POLE	7,2x7,2	7,2x7,2
STECHE (NR.) / RIBS	8	8
TESSUTO / FABRIC Acrilico - Tempotest® Parà Ombrelloni Acrylic - Tempotest® Parà Parasols	•	•

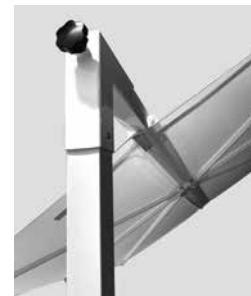

murales

ombrellone a braccio laterale addossato
in alluminio verniciato grigio antracite
lateral arm parasol attached to the wall
in aluminium anthracite grey



CARATTERISTICHE TECNICHE TECHNICAL DATA

parti metalliche prima zincate,
poi verniciate
metal parts galvanized and
varnished

stecche intercambiabili
interchangeable ribs

possibilità di posizionamento
aderente alla parete di aggancio
placement attached to the wall

predisposizione per aggancio
tramite tirante (operazione
consigliata)

prepared for docking by cable
(recommended)

OPTIONALS

finitura pendente:
flounce finishing:

 merletti
crenelation

 onde
wave



Fissaggio consigliato

In presenza di cemento armato:
Fischer \varnothing 10
If wall is in reinforced concrete:
Fischer \varnothing 10

In presenza di bimattone:
Fischer con gabbia + chimico
If wall is in perforated brick:
Fischer with cage + chemical fixing

In presenza di cappotto:
barre filettate \varnothing 10
If wall is with coat:
Threaded bars \varnothing 10



DIMENSIONE / SIZE

2x2

2,5x2,5

3x3

2x3

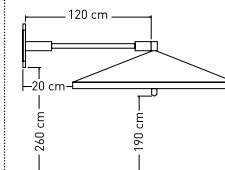
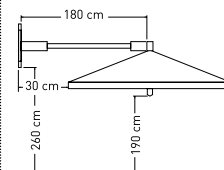
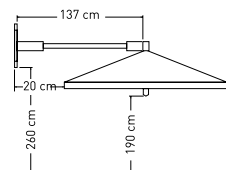
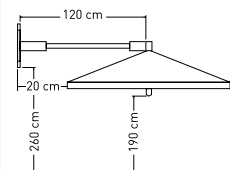

PALO (cm) / POLE

7,2x7,2

7,2x7,2

7,2x7,2

7,2x7,2

STECCHIE (NR.) / RIBS

4

4

8

6

PENDENTE / FLOUCE

•

•

•

•

TESSUTO / FABRIC

Acrilico - Tempotest® Parà Ombrelloni
Acrylic - Tempotest® Parà Parasols

•

•

•

•

eternity

ombrellone a braccio
laterale in alluminio
lateral arm parasol
in aluminium





CARATTERISTICHE TECNICHE TECHNICAL DATA

stecche intercambiabili,
sezione 2,0x3,5
interchangeable ribs,
section 2,0x3,5
parti metalliche prima zincate,
poi verniciate
metal parts galvanized
and varnished
gambone, tubo girevole e angolo
zincati a caldo
hot-galvanized leg, rotation
tube and angle

possibilità di fissaggio
al suolo
possibility of fixing
on the ground
con stecca antivento tra palo
verticale e ragno
anti-wind rib between vertical
pole and frame
360° girevole
360° rotating
ombrellone standard
fornito con pendente
standard version
with flounce

COLORI STRUTTURA FRAME COLOURS

-  grigio antracite
anthracite grey
-  bianco
white

OPTIONALS

carter copribase
coverbase carter
finitura pendente:
flounce finishing:

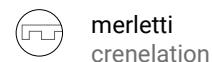

*impianto luci a led
bianche (a luce calda
su richiesta)*
*natural white led lighting
system (on demand 3000 K°)*
fioriera in alluminio
aluminium planter

asta di sicurezza
da inserire
security bar
to be inserted

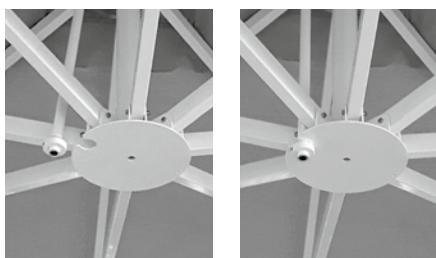

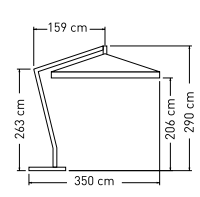
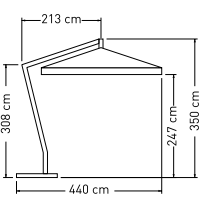
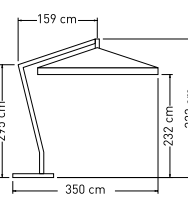
DIMENSIONE / SIZE	3x3	4x4	3x4
			
PALO (cm) / POLE	9,2x9,2	9,2x9,2	9,2x9,2
STECHE (NR.) / RIBS	8	8	8
PENDENTE / FLOUNCE	•	•	•
TESSUTO / FABRIC	•	•	•
Acrylic - Tempotest® Parà Ombrelloni - PVC Acrylic - Tempotest® Parà Parasols - PVC			

pitagora

ombrellone a braccio
laterale retrattile in alluminio
verniciato grigio antracite
e bianco

retractable aluminium
lateral arm parasol
anthracite and white
varnished



CARATTERISTICHE TECNICHE TECHNICAL DATA

sistema di chiusura retrattile
retractable closing system
possibilità di fissaggio al suolo
possibility of fixing on the ground
parti metalliche prima zincate,
poi verniciate
metal parts galvanized and
varnished

con stecca antivento tra palo
verticale e ragno
anti-wind rib between vertical
pole and frame
stecche intercambiabili
interchangeable ribs
stecche diagonali 4x4 rinforzate
reinforced diagonal
ribs for 4x4

ombrellone standard fornito
con pendente
standard version with flounce

360° girevole
360° rotating

COLORI STRUTTURA FRAME COLOURS

● grigio antracite
anthracite grey

○ bianco
white

OPTIONALS

carter copribase

coverbase carter

finitura pendente:

flounce finishing:



merletti
crenelation



onde
wave

fioriera in alluminio
aluminium planter



DIMENSIONE / SIZE

	3x3	4x4	3x4
PALO (cm) / POLE	9,2x9,2	9,2x9,2	9,2x9,2
STECHE (NR.) / RIBS	8	8	8
PENDENTE - FLOUNCE	•	•	•
TESSUTO / FABRIC Acrilico - Tempotest® Parà Ombrelloni - PVC Acrylic - Tempotest® Parà Parasols - PVC	•	•	•

eclisse

ombrellone a braccio
laterale in alluminio
verniciato grigio antracite
aluminium lateral arm
parasol anthracite varnished



dispositivo
sollevamento
(solo su 5x5)
lifting telescopic
system
(only for 5x5)

CARATTERISTICHE TECNICHE TECHNICAL DATA

possibilità di fissaggio al suolo
possibility of fixing on the ground
stecche intercambiabili e rinforzate
interchangeable and reinforced ribs
parti metalliche prima zincate,
poi verniciate
metal parts galvanized and varnished
dispositivo sollevamento telescopico
brevettato che consente la chiusura
dell'ombrellone (solo su 5x5)
patented telescopic lifting system to
close 5x5

con stecca antivento tra palo
verticale e ragno
anti-wind rib between vertical
pole and frame
ombrellone standard fornito
con pendente
standard version with flounce

OPTIONALS

base 106,5x106,5
base 106,5x106,5
carter copribase
coverbase carter
finitura pendente:
flounce finishing:

 merletti
crenelation

 onde
wave

impianto luci a led bianche
(a luce calda su richiesta)
natural white led lighting
system (on demand 3000 K°)

asta di sicurezza
da inserire
security bar
to be inserted

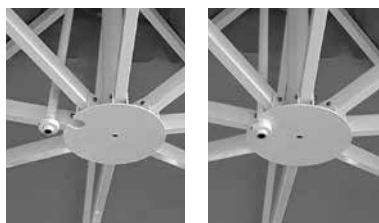
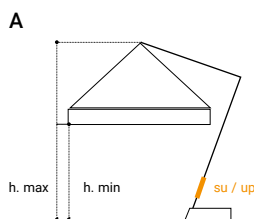

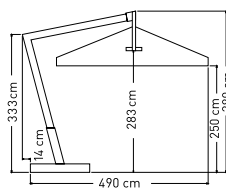
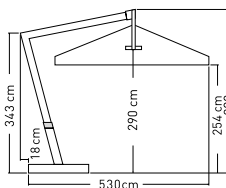
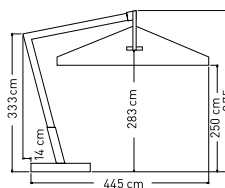
DIMENSIONE / SIZE		4,5x4,5	5x5	4x5
A	ALTEZZA - TELESCOPIO SU HEIGHT - TELESCOPE UP		440	
	h. max (cm) h. min. (cm)		304	
				
PALO (cm) / POLE		11,2x11,2	11,2x11,2	11,2x11,2
STECHE (NR.) / DIMENSIONI RIBS / DIMENSIONS		8 20x35	8 20x35	8 20x35
PENDENTE / FLOUNCE		.	.	.
TESSUTO / FABRIC Acrilico - Tempotest® Parà Ombrelloni - Tempotest® Parà Starlight Blue - PVC Acrylic - Tempotest® Parà Ombrelloni - Tempotest® Parà Starlight Blue - PVC		.	.	.

dolomiti alluminio

ombrellone a palo centrale
in alluminio
aluminium central
pole parasol



CARATTERISTICHE TECNICHE TECHNICAL DATA

possibilità di fissaggio al suolo
possibility of fixing on the ground

stecche intercambiabili
interchangeable ribs

stecche diagonali 4x4 rinforzate
reinforced diagonal ribs for 4x4

ombrellone standard fornito
con pendente (no ø 3)
standard version with
flounce (no ø 3)

COLORI STRUTTURA FRAME COLOURS

 grigio antracite
anthracite grey

 bianco
white

OPTIONALS

finitura pendente:
flounce finishing:

 merletti
crenelation

 onde
wave

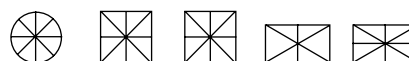
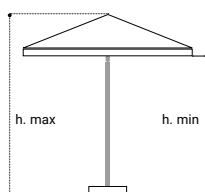

DIMENSIONE / SIZE		ø3	3x3	4x4	2x3	3x4
ALTEZZA CON BASE HEIGHT WITH BASE	h. max (cm)	263	263	328	263	294
	h. min (cm)	214	200	230	200	218
VOLUME IMBALLO m ³ PACKED VOLUME		0,08	0,10	0,14	0,09	0,12
PESO (Kg) / WEIGH		10,5	14,0	23,5	12	18,5
PALO (cm) / POLE		6,0	6,0	6,0	6,0	6,0
STECHE (NR.) / RIBS		8	8	8	6	8
PENDENTE / FLOUNCE		-	•	•	•	•
TESSUTO / FABRIC Acrilico - Tempotest® Parà Ombrelloni - PVC Acrylic - Tempotest® Parà Parasols - PVC		•	•	•	•	•

dolomiti legno

ombrellone a palo centrale
in legno

wooden central
pole parasol



CARATTERISTICHE TECNICHE TECHNICAL DATA

possibilità di fissaggio al suolo
possibility of fixing on the ground

OPTIONALS

struttura tinta iroko (no \emptyset 3 - \emptyset 3,5)
iroko colour structure (no \emptyset 3 - \emptyset 3,5)

finitura pendente:
founce finishing:

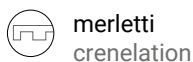

merletti
crenelation



onde
wave

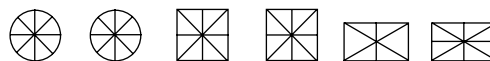
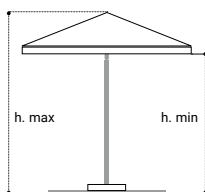

DIMENSIONE / SIZE		\emptyset 3	\emptyset 3,5	3x3	4x4	2x3	3x4
ALTEZZA CON BASE HEIGHT WITH BASE	h. max (cm)	276	276	276	336	276	308
	h. min (cm)	217	210	203	235	203	224
VOLUME IMBALLO m ³ / PACKED VOLUME		0,085	0,085	0,10	0,12	0,085	0,12
PESO (Kg) / WEIGH		13,0	13,0	17,0	29,0	13,0	23,0
PALO (cm) / POLE		4,8	4,8	4,8	5,8	4,8	4,8
STECHE (nr.) / RIBS		8	8	8	8	6	8
PENDENTE / FLOUNCE		-	-	•	•	•	•
TESSUTO / FABRIC		•	•	•	•	•	•
Acrilico - Tempotest® Parà Ombrelloni - PVC Acrylic - Tempotest® Parà Parasols - PVC							

petrarca alluminio

ombrellone a palo
centrale telescopico
in alluminio
telescopic aluminium
central pole parasol



CARATTERISTICHE TECNICHE TECHNICAL DATA

possibilità di fissaggio al suolo
possibility of fixing on the ground

stecche intercambiabili
interchangeable ribs

stecche diagonali 4x4 rinforzate
reinforced diagonal ribs for 4x4

sistema a doppio ragno che consente
la chiusura sopra i tavoli sottostanti

telescopic system for closing
over the tables below

ombrellone standard
fornito con pendente
standard version with flounce

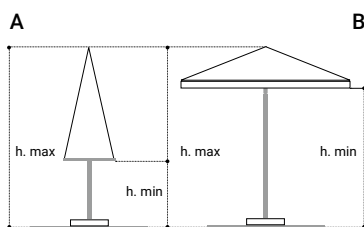

COLORI STRUTTURA FRAME COLOURS

 grigio antracite
anthracite grey

 bianco
white

OPTIONALS

finitura pendente:
flounce finishing:

 merletti
crenelation

 onde
wave



DIMENSIONE / SIZE			3x3	4x4	3x4
A	ALTEZZA CHIUSO CON BASE HEIGHT CLOSED WITH BASE	h. max (cm)	300	363	328
		h. min. (cm)	89	80	77
B	ALTEZZA APERTO CON BASE HEIGHT OPENED WITH BASE	h. max (cm)	270	320	300
		h. min. (cm)	205	228	212
VOLUME IMBALLO (SENZA BASE) m ³ PACKED VOLUME (WITHOUT BASE)			0,13	0,15	0,14
PESO (Kg) / WEIGH			17,5	25	20
PALO (cm) / POLE			6,0	6,0	6,0
STECHE (NR.) / RIBS			8	8	8
PENDENTE / FLOUNCE			.	.	.
TESSUTO / FABRIC			.	.	.
Acrilico - Tempotest® Parà Ombrelloni - PVC Acrylic - Tempotest® Parà Parasols - PVC			.	.	.

petrarca legno

ombrellone a palo
centrale telescopico
in legno

telescopic wooden
central pole parasol



CARATTERISTICHE TECNICHE TECHNICAL DATA

possibilità di fissaggio al suolo
possibility of fixing on the ground

ombrellone standard
fornito con pendente
standard version with flounce

sistema a doppio ragno
che consente la chiusura sopra
i tavoli sottostanti
telescopic system for closing
over the tables below



OPTIONALS

finitura pendente:
flounce finishing:

 merletti
crenelation

 onde
wave

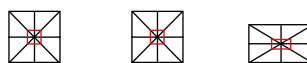
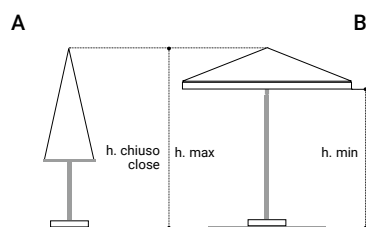
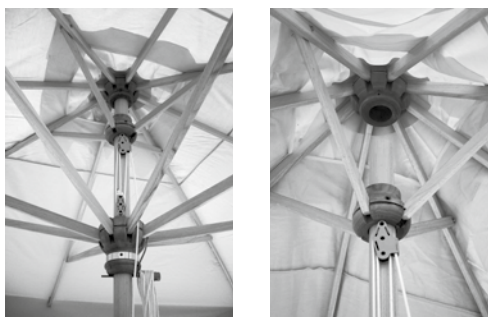

DIMENSIONE / SIZE		3x3	4x4	3x4	
A	ALTEZZA CHIUSO CON BASE HEIGHT CLOSED WITH BASE	300	383	347	
B	ALTEZZA APERTO CON BASE HEIGHT OPENED WITH BASE	h. max (cm)	274	334	308
		h. min. (cm)	205	240	224
VOLUME IMBALLO (SENZA BASE) m ³ PACKED VOLUME (WITHOUT BASE)		0,10	0,15	0,14	
PESO (Kg) / WEIGH		18	31	24	
PALO (cm) / POLE		4,8	5,8	4,8	
STECHE (NR.) / RIBS		8	8	8	
PENDENTE / FLOUNCE		•	•	•	
TESSUTO / FABRIC Acrylic - Tempotest® Parà Ombrelloni - PVC Acrylic - Tempotest® Parà Parasols - PVC		•	•	•	





ocean alluminio

ombrellone a palo centrale
in alluminio
aluminium central
pole parasol

CARATTERISTICHE TECNICHE TECHNICAL DATA

possibilità di fissaggio al suolo
possibility of fixing on the ground
ombrellone standard
fornito senza pendente
standard version without flounce
apertura a sollevamento,
senza carrucole
opening system by lifting,
without pulleys

COLORI STRUTTURA FRAME COLOURS

-  grigio antracite
anthracite grey
-  bianco
white

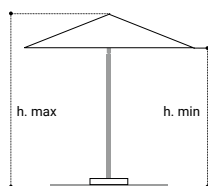

ocean legno

ombrellone a palo centrale
in legno
wooden central
pole parasol

CARATTERISTICHE TECNICHE TECHNICAL DATA

possibilità di fissaggio al suolo
possibility of fixing on the ground
ombrellone standard
fornito senza pendente
standard version without flounce
apertura a sollevamento,
senza carrucole
opening system by lifting,
without pulleys



DIMENSIONE / SIZE		Ø2	Ø2,5	Ø3	2x2	2,5x2,5	2,8x2,8	2x3
ALTEZZA CON BASE HEIGHT WITH BASE	h. max (cm)	246	246	246	246	251	260	251
	h. min. (cm)	208	200	198	200	200	210	193
PALO (cm) / POLE		3,8	3,8	3,8	3,8	3,8	3,8	3,8
STECHE (NR.) / RIBS		6	6	6	4	4	4	4
TESSUTO / FABRIC	
Olefin 190 g - tinto in massa Olefin 190 g - high color stability	

laguna

ombrellone a palo centrale
in legno

wooden central
pole parasol



CARATTERISTICHE TECNICHE TECHNICAL DATA

possibilità di fissaggio al suolo
possibility of fixing on the ground

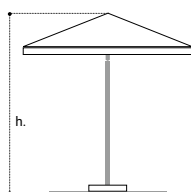

DIMENSIONE / SIZE	2x2	3x3	2x3
ALTEZZA HEIGHT	265	270	270
VOLUME IMBALLO (SENZA BASE) m ³ PACKED VOLUME (WITHOUT BASE)	0,05	0,10	0,085
PESO (Kg) / WEIGH	7,5	14	8
PALO (cm) / POLE	3,8	4,8	3,8
STECHE (NR.) / RIBS	4	8	6
PENDENTE / FLOUNCE	•	•	•
TESSUTO / FABRIC Olefin 190 g - tinto in massa Olefin 190 g - high color stability	•	•	•

city

mezzo ombrellone in alluminio
verniciato grigio antracite
aluminium anthracite grey
varnished half-parasol



CARATTERISTICHE TECNICHE TECHNICAL DATA

possibilità di fissaggio
al suolo e a muro
possibility of fixing on the
ground/to the wall

ombrellone standard fornito
con pendente
standard version with flounce

stecche intercambiabili
interchangeable ribs for

OPTIONALS

finitura pendente:
flounce finishing:

 merletti
crenelation

 onde
wave

staffa di fissaggio a muro
plate for fixing to the wall

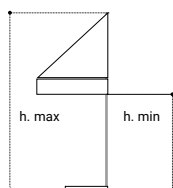

DIMENSIONE / SIZE		1,5x2	1,5x3	2x3	2x4
ALTEZZA CON PIASTRA ACCIAIO HEIGHT WITH STEEL PLATE	h. max (cm)	255	255	285	315
	h. min. (cm)	192	183	218	223
VOLUME IMBALLO m ³ PACKED VOLUME m ³		0,09	0,10	0,12	0,14
PALO (cm) / POLE		6	6	6	6
STECHE (NR.) / RIBS		4	5	5	5
PENDENTE / FLOUNCE		•	•	•	•
TESSUTO / FABRIC Acrilico - Tempotest® Parà Ombrelloni - PVC Acrylic - Tempotest® Parà Parasols - PVC		•	•	•	•

ZAVORRA MINIMA - MINIMUM WEIGHT

Il peso della zavorra sulla base deve essere proporzionato al peso e alle dimensioni dell'ombrellone. Se ne consiglia comunque l'uso in condizioni meteorologiche sostanzialmente normali.

It is recommended the weight of the base proportionate to the weight of the parasol and the use with normal meteorological conditions.

MODELLO / MODEL	PIASTRA LAVATO 40x40	PIASTRA LAVATO 50x50	PIASTRONE CEMENTO 40x40 con maniglie	PIASTRONE CEMENTO 50x50 con maniglie
	WASHED PLATE 40x40	WASHED PLATE 50x50	BIG WASHED PLATE 40x40 with handles	BIG WASHED PLATE 50x50 with handles
LEONARDO		x 12		x 4
LEONARDO 6x6 a 12 stecche LEONARDO 6x6 with 12 ribs LEONARDO 5x7 a 10 stecche LEONARDO 5x7 with 10 ribs LEONARDO 6,5x6,5 LEONARDO 6,5x6,5 LEONARDO 7x7 LEONARDO 7x7 LEONARDO 6x7 LEONARDO 6x7		x 24		x 8
GALILEO 6X6		x 12		x 4
GALILEO 7x7 - 8x8		x 24		x 8
FELLINI "T"		x 12		x 4
FELLINI "V" 3X6 - 3X8		x 12		x 4
FELLINI "V" 3,5x7 - 4x8		x 24		x 8
ECLISSE		x 24		x 8
ETERNITY 3x3		x 8		x 4
ETERNITY 3x4		x 10		x 4
ETERNITY 4x4		x12		x4
FLAT		x 6		x 2
2x2 TUTTI I MODELLI A BRACCIO LATERALE 2x2 ALL LATERAL ARM MODELS		x 6		x 2
2,5x2,5 TUTTI I MODELLI A BRACCIO LATERALE 2,5x2,5 ALL LATERAL ARM MODELS		x 6		x 2
2x3 TUTTI I MODELLI A BRACCIO LATERALE 2x3 ALL LATERAL ARM MODELS		x 6		x 2
3x3 TUTTI I MODELLI A BRACCIO LATERALE 3x3 ALL LATERAL ARM MODELS		x 8		x 4
3x4 TUTTI I MODELLI A BRACCIO LATERALE (NO Eternity) 3x4 ALL LATERAL ARM MODELS (NO ETERNITY)		x 8		x 4
4x4 TUTTI I MODELLI A BRACCIO LATERALE (NO Eternity) 4x4 ALL LATERAL ARM MODELS (NO ETERNITY)		x 10		x 4
CITY 1,5x2 - 1,5x3 - 2x3	PIASTRA ACCIAIO 70x70 - STEEL PLATE 70x70			x 1
CITY 2x4	PIASTRA ACCIAIO 100x100 - STEEL PLATE 100x100			x 1

MODELLO / MODEL	BASE ROTONDA GRANIGLIA 25 Kg.	BASE ROTONDA GRANIGLIA 35 Kg.	BASE ROTONDA GRANIGLIA 50 Kg.	BASE ROTONDA GRANIGLIA 70 Kg. con maniglie	PIASTRA ACCIAIO 70x70	PIASTRA ACCIAIO 100x100
	ROUND GRIT BASE 25 Kg.	ROUND GRIT BASE 35 Kg.	ROUND GRIT BASE 50 Kg.	ROUND GRIT BASE 70 Kg. with handles	STEEL PLATE 70x70	STEEL PLATE 100x100
DOLOMITI LEGNO / ALLUMINIO		2x3	ø3 - ø3,5 3x3 - 3x4 4x4		ø3 - ø3,5 2x3 - 3x3	3x4 4x4
PETRARCA LEGNO / ALLUMINIO			3x3	3x4 - 4x4		3x3 - 3x4 - 4x4
OCEAN	ø2 - ø2,5 2x2	ø3 2,5x2,5 2,8x2,8 2x3			ø2 - ø2,5 ø3 - 2x2 2,5x2,5 2,8x2,8 2x3	
LAGUNA		2x2 2x3	3x3		2x2 2x3 - 3x3	

accessori optionals



LAVORAZIONI PENDENTI FLOUNCE FINISHING



merletti
crenelation



onde
wave



CANALINE GUTTERS

di serie in GALILEO
e FELLINI.
standard for GALILEO
and FELLINI.

Con zip, velcro e Cristal
all'interno, per LEONARDO
in tessuto.

Lined with zip, velcro
and Cristal inside, for
LEONARDO in fabric.



FODERI PROTECTION COVERS

In acrilico ecrù o PVC
per tutti i modelli.
In acrylic ecrù or PVC
for all the models.



IMPIANTO LED A LUCE BIANCA NATURALE 4000 K* (SU RICHIESTA A 3000 K* CALDA)

NATURAL WHITE LED LIGHTING
SYSTEM 4000K* (ON DEMAND 3000K*)

Impianto integrato per LEONARDO
ed ECLISSE, con telecomando.
Integrated lighting system, remote
control included, for LEONARDO
and ECLISSE.

Impianto universale integrato
(vedi modelli a braccio laterale
su cui previsto).

Integrated universal lighting system
(see the models on which it is intended).

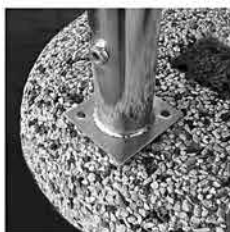

BASI IN GRANIGLIA GRIT BASES

Per ombrelloni con palo
centrale:

For the parasols with
central poles:
Ø 38, Ø 48, Ø 58, Ø 60

Kg. 70

Con maniglie e tubo con piastra
a doppio foro.

With handles and complete tube
with double hole plate.

Kg. 50 - Kg. 35

Con tubo e piastra a doppio
foro.

Complete tube with double hole
plate.

Kg. 25

Con tubo e piastra a foro unico.
Complete tube with single hole
plate.



CONTROPIASTRE COUNTERPLATES

Da cementare a scomparsa.
To be cemented and flush
fitted.

Per fissaggio a pavimento.
For fixing into the floor.



PIASTRE LAVATO WASHED PLATES

50x50
Per ombrellone
LEONARDO, per tutti i
modelli multipli
e a braccio laterale.

For LEONARDO, for all the
multiple and lateral arm
models.

40x40

Per PETRARCA
For PETRARCA



PIASTRONI CEMENTO BIG WASHED PLATES

50x50 - 40x40
CON MANIGLIE
Per ombrellone LEONARDO,
CITY, per tutti i modelli
multipli e a braccio laterale

WITH HANDLES
For LEONARDO, CITY, for
all the multiple and lateral
arm models.



PIASTRA ZINCATA E VERNICIATA GALVANIZED AND PAINTED STEEL PLATE

20x20

Solo per fissaggio a
pavimento.

Just for fixing into the floor.

70x70 - kg. 21

Anche con tubo decentrato
per CITY.

Also with decentralized tube
for CITY.

100x100 - kg 40

Anche con tubo decentrato
per CITY 2x4.

Also with decentralized tube
for CITY 2x4.



FIORIERA ALLUMINIO ALUMINIUM PLANTER

Antracite, bianca, tortora.
Anthracite, white, dove colour.

Misure:

Dimensions:
104x50xh34 cm.



FIORIERA LEGNO WOODEN PLANTER

Misure:

Dimensions:
104x50xh 34 cm.



CARTER COPRI BASE CARTER BASE COVER

Vedi modelli su cui
previsto.
see the models on which it
is intended.

tessuti fabrics

Le immagini stampate non riproducono perfettamente i colori e i toni dei nostri modelli. L'azienda si riserva di apportare tutte le modifiche ritenute necessarie al continuo miglioramento e rinnovamento dei modelli.

The printed images do not reproduce perfectly the colours and shades of our models. The company reserves the rights to make all modification necessary for the improvement and renewal of the model.

ACRILICO / ACRYLIC

gr. 320 m/q.



ECRU

BIANCO

CORDA

TEMPOTEST® PARÀ OMBRELLONI / PARASOLS

gr. 300 m/q. tinto in massa / dyed in bulk

TEMPOTEST®
ITALIAN PERFORMANCE FABRICS

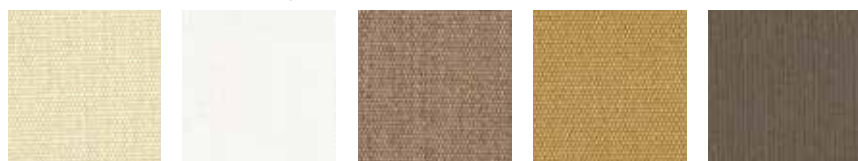

ECRU
Cod. 151/15

BIANCO
Cod. 15

NOCCIOLA
MELANGIATO
Cod. 106

CORDA
Cod. 14

TORTORA
Cod. 926



GRIGIO
COD. 97/15

GRIGIO CHIARO
COD. 79

GRIGIO CHIARO
TRAMATO
COD. 986/727

TESTA DI MORO
COD. 81

NERO
COD. 24



BORDEAUX
COD. 73

VERDE BOSCO
COD. 5

TERRACOTTA
COD. 426

GIALLO
COD. 12/15

TEMPOTEST® PARÀ STARLIGHT BLUE

tinto in massa / dyed in bulk

TEMPOTEST®
ITALIAN PERFORMANCE FABRICS

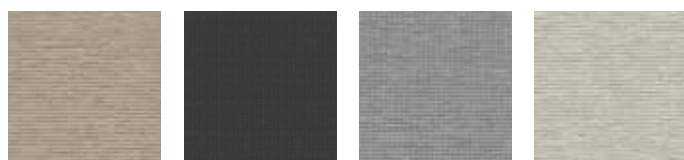

NOCCIOLA
COD. 6236/590

ANTRACITE
COD. 6253/597

GRIGIO CHIARO
COD. 6231/597

ECRU
COD. 6254/551

PVC
gr. 500 m/q.



BIANCO
COD. 867

ECRU
COD. 7462

OLEFIN

gr. 190 tinto in massa / dyed in bulk

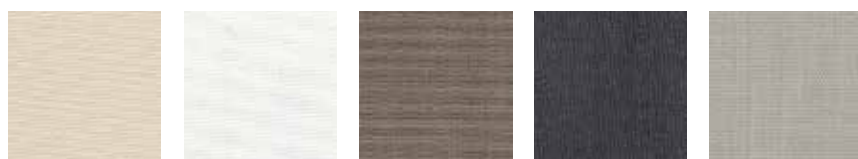

ECRU 2710

BIANCO 2602

TORTORA 2739

ANTRACITE 2657

GRIGIO CHIARO 2649





AVVERTENZE WARNINGS

- Il peso della zavorra sulla base deve essere proporzionato al peso e alle dimensioni dell'ombrellone. Se ne consiglia comunque l'uso in condizioni metereologiche sostanzialmente normali.
 - A stagione conclusa, assicurarsi che il telo sia asciutto prima di riporre l'ombrellone, onde evitare eventuali formazioni di muffa.
 - Chiudere sempre l'ombrellone al termine dell'utilizzo.
 - Per facilitarne l'apertura, accompagnare le stecche corte verso l'esterno.
 - Nei modelli a braccio laterale, ad ombrellone chiuso, assicurarsi che il cavo per l'apertura sia sempre in tensione.
 - Non trascinare a terra gli ombrelloni ma sollevarli, onde evitare di rovinare la tela (effetto buco da sigaretta).
- It is recommended the weight of the base proportionate to the weight of the parasol and the use with normal meteorological conditions.
 - At concluded season, be sure that the fabric is dry before putting parasol back, to avoid possible mould formations.
 - To make the opening easier, take the short ribs towards the outside ones.
 - Close always parasols at the end of the use.
 - In lateral arm models, the cable have to be always in tension when parasol is closed.
 - Do not drag parasols but raise them (even if packaged). Ombrellificio Veneto® cannot be responsible for damages by dragging (holes like bore by cigarette at the corner of the flounces).

Photo and render:
Grafiche Antiga spa
Pellizzari - Rigo

Graphic design, layout and printing:
Grafiche Antiga spa

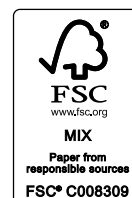



Ombrellificio Veneto Srl
Via dell'Industria, 5
35044 Montagnana (PD) - Italy

Tel. +39 0429 804098
Fax +39 0429 804096

www.ombrellificioveneto.it
commerciale@ombrellificioveneto.it