



**BDK
GLASS**

Společnost BDK-GLASS, spol. s r.o.



BDK-GLASS, spol. s r.o. je specifickou firmou v rámci sklářského průmyslu díky své výrobní technologii FUSING.

Společnost BDK-GLASS byla založena v r. 1991. Již v roce 1992 byla technologie fusing výrobně odzkoušena a obchodně zhodnocena. S postupným rozšiřováním výrobní kapacity docházelo i k diverzifikaci podnikatelské činnosti – k nákupu zařízení pro pískování skla, CNC řezání skla, postavena kontinuální plynová pec atd. Společnost vyrábí zejména dekorativní a užitkové mísy, misky, tácy a talíře, skleněné svícný, dárkové předměty.

Na zakázku vyrábí i skleněné výplně do dveří a skleněné stoly. Společnost si vytvořila vlastní osobitý styl. Sama si zpracovává návrhy výrobků, které se vyznačují moderním designem a originalitou. Výroba je zcela ekologická, v podstatě bezodpadová.

Od svého počátku společnost dodává své výrobky zejména na zahraniční trhy ve vyspělých evropských zemích a severní Americe. BDK-GLASS, spol. s r.o. disponuje zbožím, které odběratele zajímá svojí variabilitou a originalností ruční práce. Významnými zákazníky jsou v posledních letech i cateringové společnosti.

Filosofie výroby BDK-GLASS, spol. s r.o. spočívá v hromadné flexibilní výrobě širokého sortimentu výrobků s maximálním důrazem na design výrobku a v přijatelné cenové hladině.

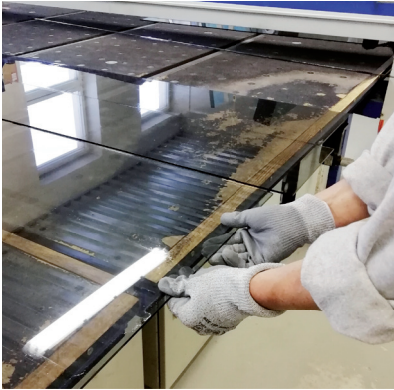

Company BDK-GLASS, spol. s r.o.

BDK-GLASS was established in Czechoslovakia in 1991. We are a small, family company whose production is focused on the manual processing of clear and coloured flat glasses through the FUSING technology.

FUSING is based on fusing flat glasses together and subsequently shaping them in furnaces at temperatures around 800°C. Our company mainly supplies large and small bowls, trays, coasters, decorative candlesticks, gift items, and original glass trophies.

These products are used mainly in food preparation and service, flower arranging, and residential architecture and decoration. We also produce glass door panels, kitchen cabinet panels, glass tables, and more.

We enjoy creating our own modern designs with fresh styles and originality, and this creativity has become a characteristic feature of our company. However, we are very flexible and we are happy to satisfy customer proposals. Although we produce our glass by hand, we keep our prices favourable for every customer. Production is ecological and basically wasteless.

BDK-GLASS mainly exports its product to European countries and North America. Customers especially appreciate our products' versatility and the originality that comes from manual processes.

OBSAH

Talíře Plates	5 - 17
Tácy Trays	19 - 29
Mísy Bowls	31 - 39
Rautové schody a etažéry Step trays	41 - 50
Dekoratívni svícny Candlesticks	52 - 61
Dekoratívni mísy Decorative bowls	63 - 64
Barevný vzorník Range of colors in production	66

TALÍŘE | PLATES

Plates

Talíře



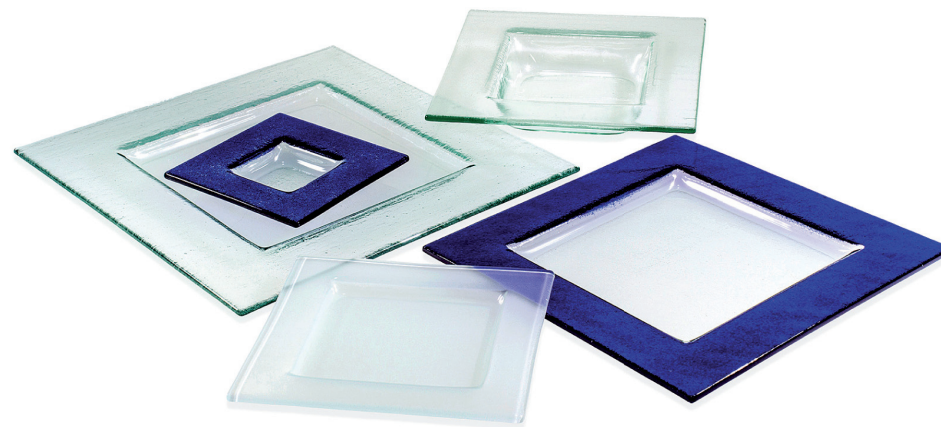
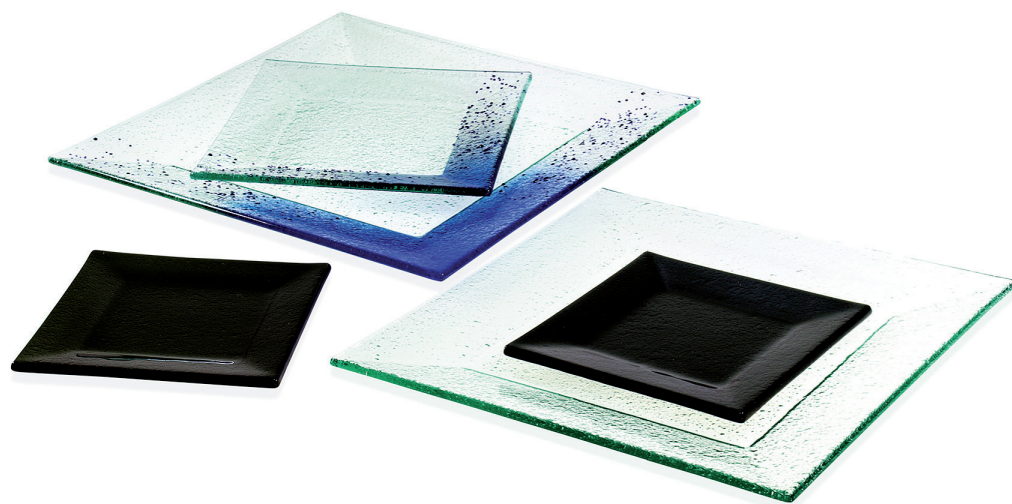

TALÍŘE MAX | MAX PLATES

TALÍŘE BORDER | BORDER PLATES

Kód | Code **Rozměr | Size**

5300xx	15 x 15 cm
5301xx	20 x 20 cm
5302xx	28 x 28 cm
5303xx	32 x 32 cm

xx - Dvojcísli určující barvu výrobku
xx - Number of individual color

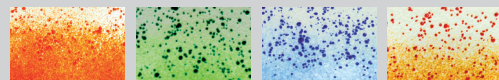

01 red 02 green 03 blue 04 orange

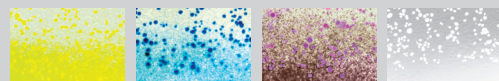

06 yellow 08 turquoise 09 violet 10 white



20 clear 21 sanded 22 dark grey 30 grey



Kód | Code **Rozměr | Size**

5091xx	13 x 13 cm
5093xx	17 x 17 cm
5095xx	21 x 21 cm hloubka depth 3 cm
5097xx	25 x 25 cm
5099xx	31 x 31 cm

xx - Dvojcísli určující barvu výrobku
xx - Number of individual color

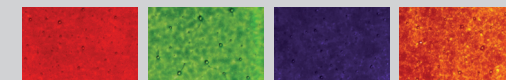

01 red 02 green 03 blue 04 orange



06 yellow 07 beige 08 light turquoise 19 violet

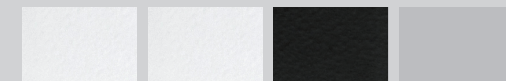

20 clear 21 sanded 22 dark grey





Nature talíře kulaté |
Nature plates str. 11

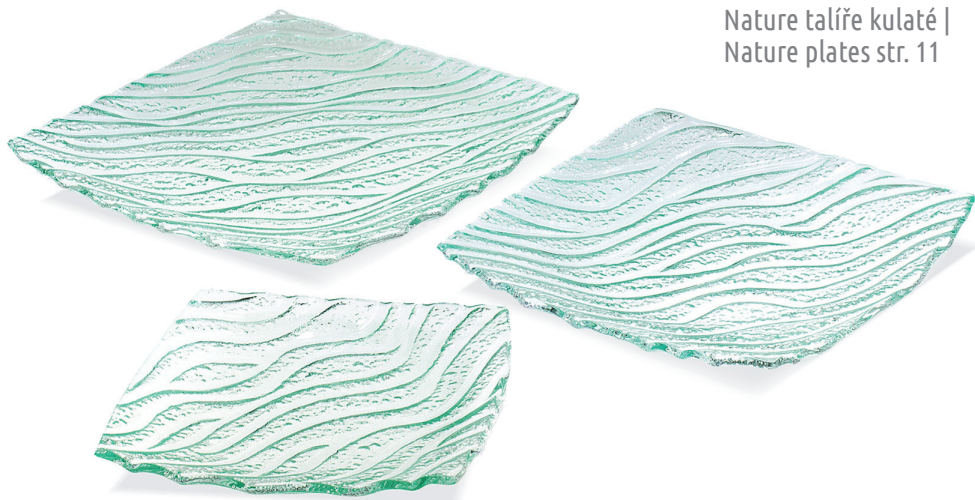

Nature talíře kulaté |
Nature plates str. 11

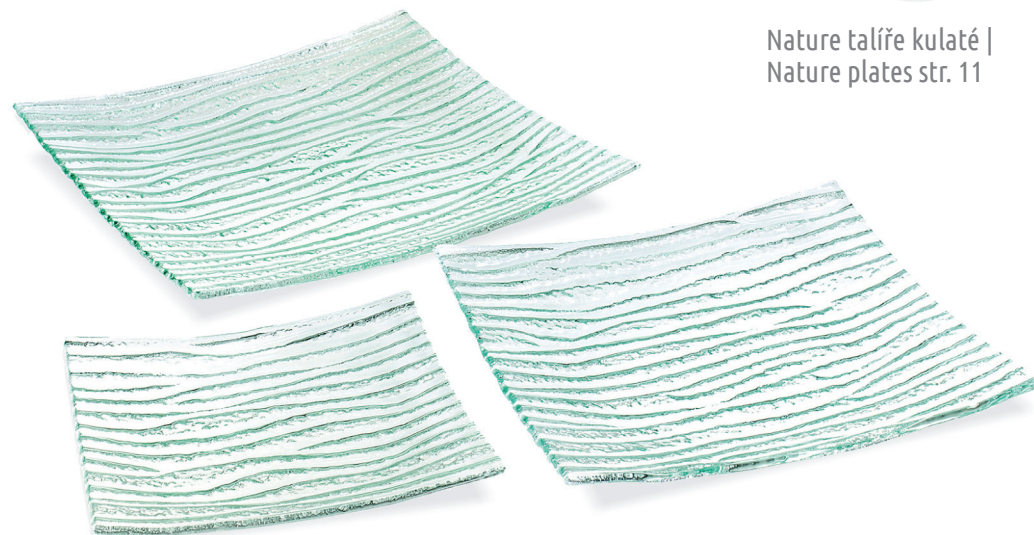

TALÍŘE NATURE | NATURE PLATES

Kód | Code **Rozměr | Size**

535x1y 20 x 20 cm

535x3y 27 x 27 cm

535x5y 31 x 31 cm

x - Číslice určující barvu výrobku
x - Number of individual color

y - Číslice určující strukturu výrobku
y - Number of individual structure

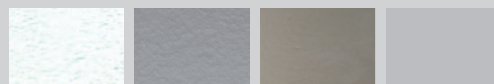

2 clear 5 grey 8 bronze x



1 moonoscape 2 bark 3 sea y



TALÍŘE NATURE | NATURE PLATES

Kód | Code **Rozměr | Size**

535x1y 20 x 20 cm

535x3y 27 x 27 cm

535x5y 31 x 31 cm

x - Číslice určující barvu výrobku
x - Number of individual color

y - Číslice určující strukturu výrobku
y - Number of individual structure

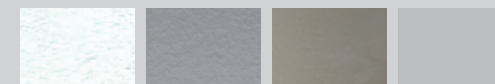

1 clear 4 grey 7 bronze x



1 moonoscape 2 bark 3 sea y



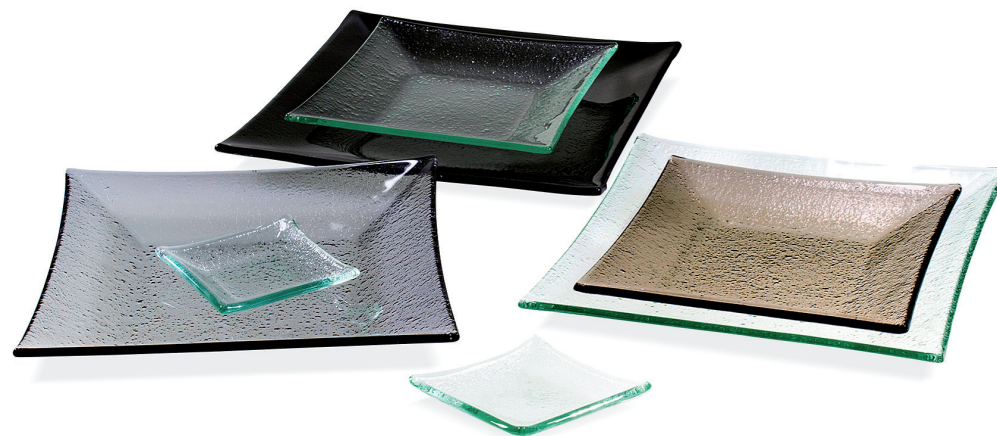



Cubo mísy | bowls str. 34

TALÍŘE SAFARI | SAFARI PLATES

TALÍŘE CUBO | CUBO PLATES

Kód Code	Rozměr Size
 5280xx	13 x 13 cm
5281xx	16 x 16 cm
5282xx	20 x 20 cm
5283xx	25 x 25 cm
5285xx	31 x 31 cm
 5284xx	29 x 29 cm hloubka depth 5 cm

xx - Dvojcísle určující barvu výrobku
xx - Number of individual color

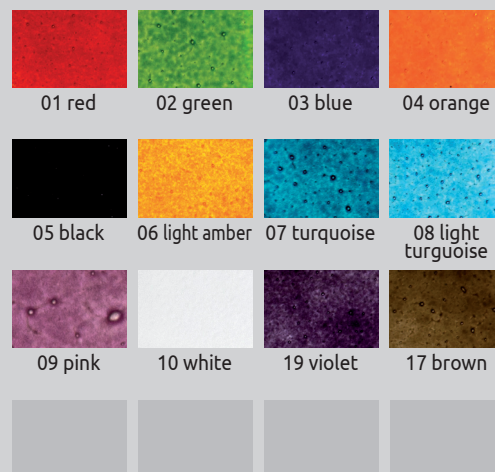

Kód Code	Rozměr Size
5252x0	10 x 10 cm
5252x2	20 x 20 cm
5252x4	25 x 25 cm
5252x6	28 x 28 cm

x - Číslice určující barvu výrobku
x - Number of individual color

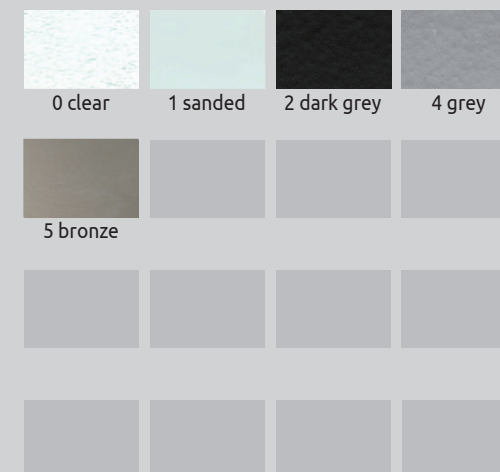

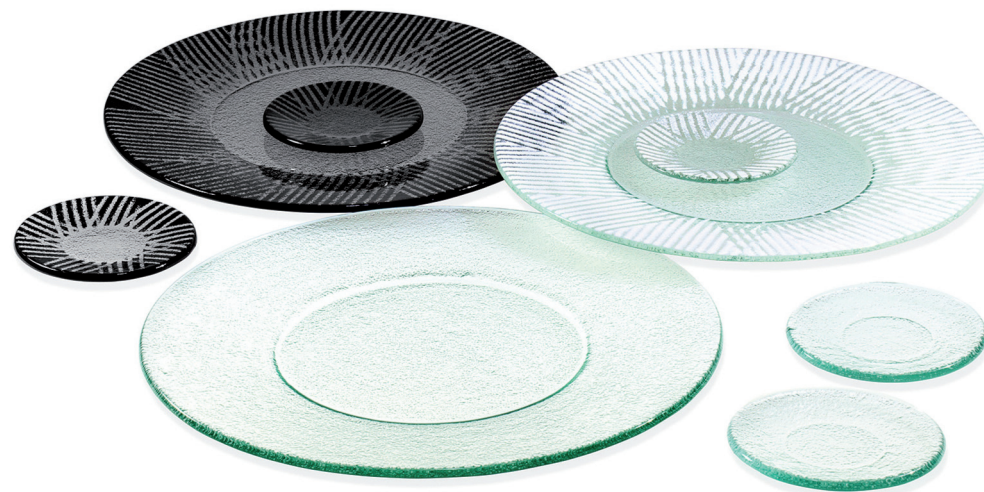

TALÍŘE BAND | BAND PLATES

Kód | Code **Rozměr | Size**

5061xx	ø 13 cm
5062xx	ø 20 cm
5064xx	ø 26 cm
5066xx	ø 32 cm
5068xx	ø 40 cm

xx - Dvojcíslný určující barvu výrobku
xx - Number of individual color



TALÍŘE FLASH | FLASH PLATES

Kód | Code **Rozměr | Size**

54460xx	ø 11 cm
54465xx	ø 32 cm

xx - Dvojcíslný určující barvu výrobku
xx - Number of individual color

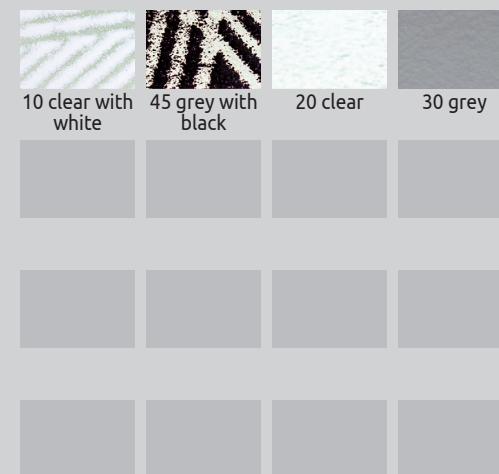



TALÍŘE CAKE | CAKE PLATES

TALÍŘE BUBBLE | BUBBLE PLATES

Kód | Code **Rozměr | Size**

50730xx ø 16 cm

50733xx ø 28 cm

50736xx ø 33 cm

xx - Dvojčíslí určující barvu výrobku
xx - Number of individual color



MĚLKÉ TALÍŘE | SHALLOW PLATES

Kód | Code **Rozměr | Size**

52042xx ø 20 cm

52012xx ø 28 cm

52032xx ø 31 cm

HLUBOKÉ TALÍŘE | DEEP PLATES

Kód | Code **Rozměr | Size**

52052xx ø 17 cm

52022xx ø 26 cm



52062xx ø 31 cm

xx - Dvojčíslí určující barvu výrobku
xx - Number of individual color

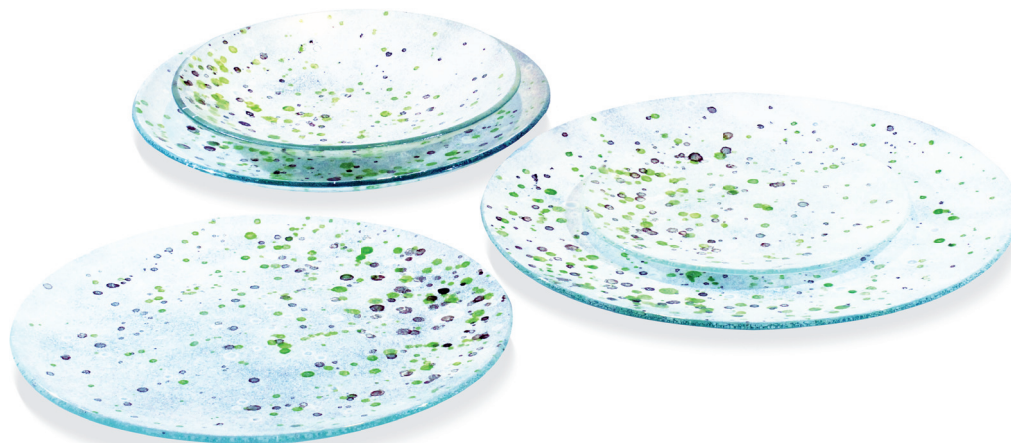
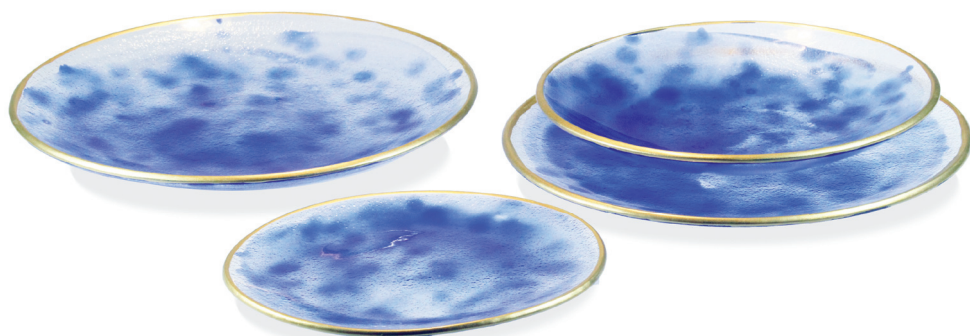





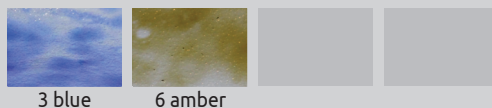

TALÍŘE COUNTRY I. | COUNTRY I. PLATES

Kód Code	Rozměr Size
 5473022x ø 20 cm	
5473222x ø 28 cm	
 5473422x ø 25 cm	
5473522x ø 29 cm	

x - Číslice určující barvu výrobku
x - Number of individual color



TALÍŘE COUNTRY II. | COUNTRY II. PLATES

Kód Code	Rozměr Size
 5471020xx ø 20 cm	
5471220xx ø 28 cm	
5471420xx ø 33 cm	
 5471120xx ø 25 cm	
 5471320xx ø 28 cm	
 5471520xx ø 29 cm	

xx - Dvojcíslicí určující barvu výrobku
xx - Number of individual color



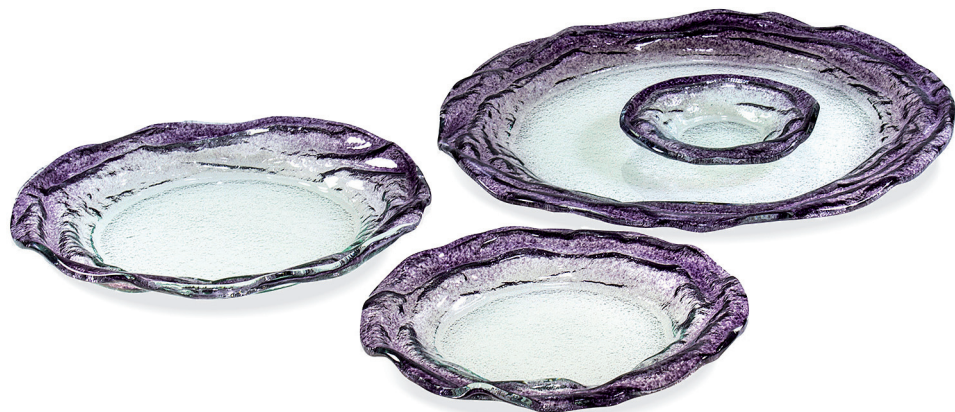

Nature talíře čtvercové |
Nature plates str. 6



Nature talíře čtvercové |
Nature plates str. 6

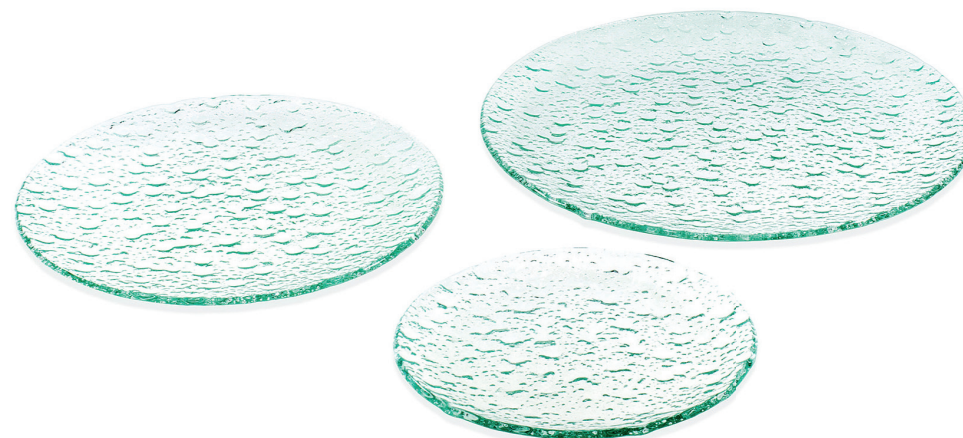

TALÍŘE MELODY | MELODY PLATES

TALÍŘE NATURE | NATURE PLATES

Kód | Code Rozměr | Size

54471xx	ø 13 cm
54473xx	ø 21 cm
54475xx	ø 25 cm
54477xx	ø 33 cm

xx - Dvojcísle určující barvu výrobku
xx - Number of individual color



Kód | Code Rozměr | Size

535x1y	ø 21 cm
535x3y	ø 28 cm
535x5y	ø 35 cm

x - Číslice určující barvu výrobku
x - Number of individual color

y - Číslice určující strukturu výrobku
y - Number of individual structure

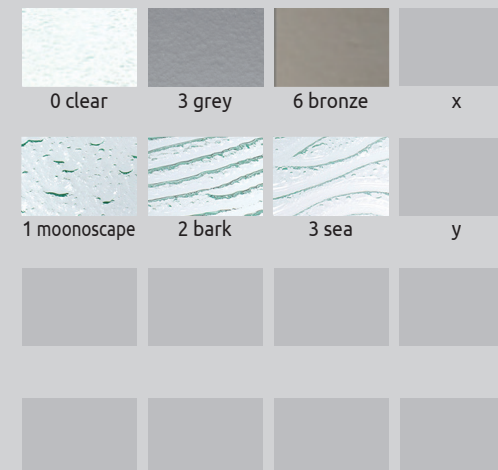





Etažér | Cake 3-storey
whatnot - str. 50



Etažér |
Cake whatnot - str. 49





TALÍŘE VELO | VELO PLATES

Kód Code	Rozměr Size
 55134xx	ø 20 cm
55138xx	ø 28 cm
 55132xx	ø 18 cm
55136xx	ø 23 cm

xx - Dvojcíslní určující barvu výrobku
xx - Number of individual color



TALÍŘE STUMP | STUMP PLATES

Kód Code	Rozměr Size
 55102xx	ø 20 cm
55106xx	ø 28 cm
 55104xx	ø 24 cm



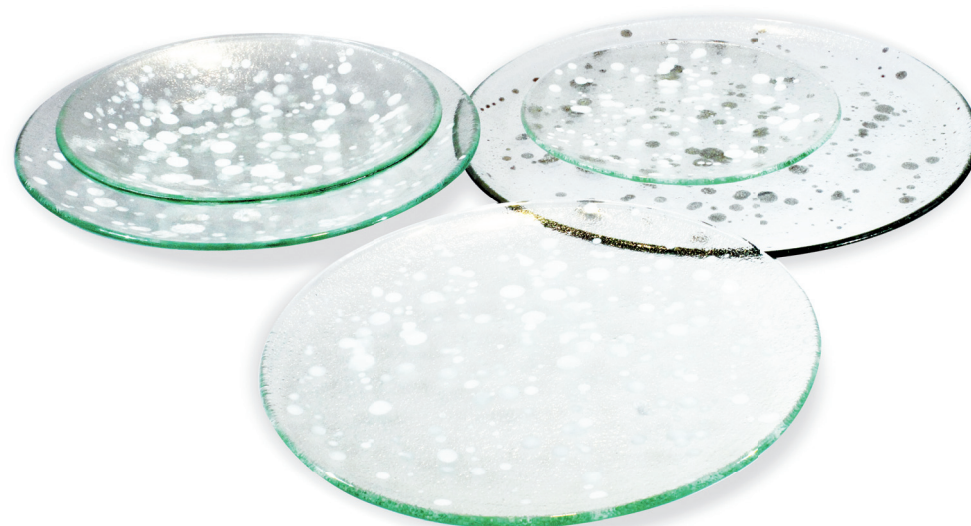

xx - Dvojcíslní určující barvu výrobku
xx - Number of individual color





TALÍŘE COUNTRY III. | COUNTRY III. PLATES

TALÍŘE COUNTRY IV. | COUNTRY IV. PLATES





Kód Code	Rozměr Size
 547202xy ø 20 cm	
 547222xy ø 28 cm	
 547242xy ø 25 cm	
 547252xy ø 29 cm	

x - Číslice určující barvu okraje
x - Number of rim color

y - Číslice určující barvu výrobku
y - Number of individual color



další barevné varianty - viz. vzorník barev - str. 66
another color variations can be found in the color swatch - p. 66

Kód Code	Rozměr Size
 547203xx ø 20 cm	
 547223xx ø 28 cm	
 547243xx ø 25 cm	
 547253xx ø 29 cm	

xx - Dvojcíslicí určující barvu výrobku
xx - Number of individual color

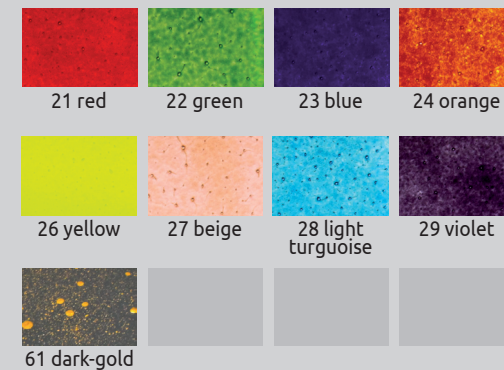

další barevné varianty - viz. vzorník barev - str. 66
another color variations can be found in the color swatch - p. 66





Talíře ANTIQUE I
ANTIQUÉ Plates str. 15

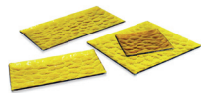

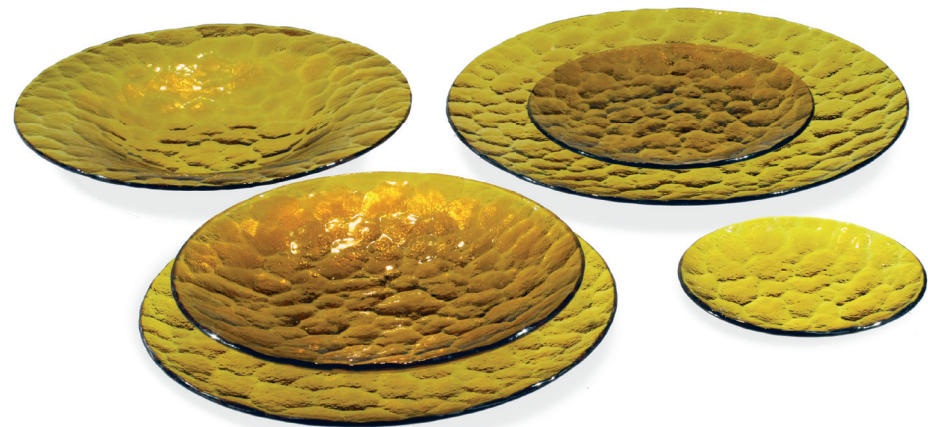

Tácy ANTIQUE I
ANTIQUÉ Trays str. 25



Oval Ella II. talíře | Oval
Ella II. plates - str. 17



TALÍŘE ANTIQUE | ANTIQUÉ PLATES

Kód Code	Rozměr Size
 5056101	ø 15 cm
5056111	ø 20 cm
5056131	ø 28 cm
5056161	ø 33 cm
 5056141	ø 28 cm
 5056181	ø 25 cm
5056191	ø 29 cm



amber



KULATÉ TALÍŘE ELLA | ROUND ELLA PLATES

Kód Code	Rozměr Size
547202xx	ø 20 cm
547222xx	ø 28 cm
547232xx	ø 28 cm hluboký deep

xx - Dvojčíslí určující barvu ráfku
xx - Number of rim color



80 gold

90 silver



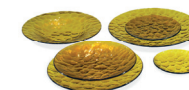

Talíře ANTIQUE I
ANTIQUÉ Plates str. 14

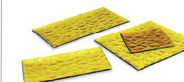

Tácky ANTIQUE I
ANTIQUÉ Trays str. 25



TALÍŘE OLYMPIA | OLYMPIA PLATES

TALÍŘE ANTIQUE | ANTIQUE PLATES

Kód | Code Rozměr | Size

51552xx 26 x 11 cm

51554xx 33 x 14 cm

xx - Dvojčíslí určující barvu výrobku
xx - Number of individual color

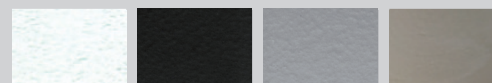

20 clear 22 dark grey 30 grey 50 bronze



40 extra clear



Kód | Code Rozměr | Size

5056311 20 x 14 cm

5056331 30 x 23 cm

5056351 34 x 26 cm



amber



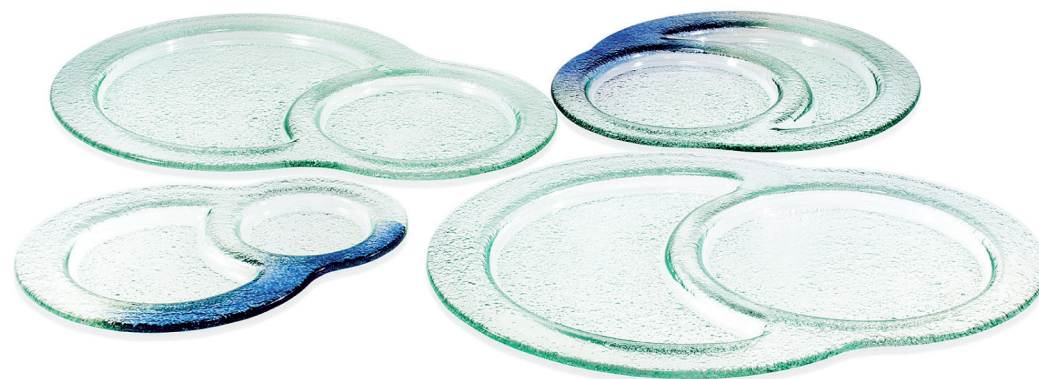

TALÍŘE AMEBA I. | AMEBA I. PLATES

Kód | Code **Rozměr | Size**

5360xx	19 x 15 cm
5362xx	24 x 19 cm
5364xx	29 x 24 cm
5366xx	40 x 24 cm

xx - Dvojcíslní určující barvu výrobku
xx - Number of individual color



TALÍŘE AMEBA II. | AMEBA II. PLATES

Kód | Code **Rozměr | Size**

5376xx	25 x 18 cm
5370xx	26 x 28 cm
5372xx	37 x 30 cm
5374xx	38 x 28 cm

xx - Dvojcíslní určující barvu výrobku
xx - Number of individual color





Kulaté talíře Ella | Round
Ella plates - str. 14



TALÍŘE OVAL ELLA | OVAL ELLA PLATES

TALÍŘE OVAL ELLA II. | OVAL ELLA II. PLATES

Kód | Code **Rozměr | Size**

51571xx 20 x 14 cm

51573xx 30 x 23 cm

51575xx 34 x 26 cm

xx - Dvojcíslní určující barvu výrobku
xx - Number of individual color

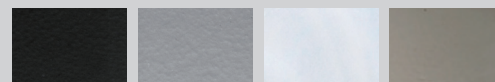

22 dark grey 30 grey 40 extra clear 50 bronze



Kód | Code **Rozměr | Size**

51571xx 20 x 14 cm

51573xx 30 x 23 cm

51575xx 34 x 26 cm

xx - Dvojcíslní určující ráfek výrobku
xx - Number of rim color



80 gold 90 silver





TÁCY | TRAYS
Trays *Tácy*



Obdelníkové tácy ZOOM I. I ZOOM I. Trays str. 24



Tácy ZOOM II. I ZOOM II. Trays str. 29



Kulaté tácy ZOOM I Round ZOOM Trays str. 28



Servírovací tácy I SERVING Trays str. 26

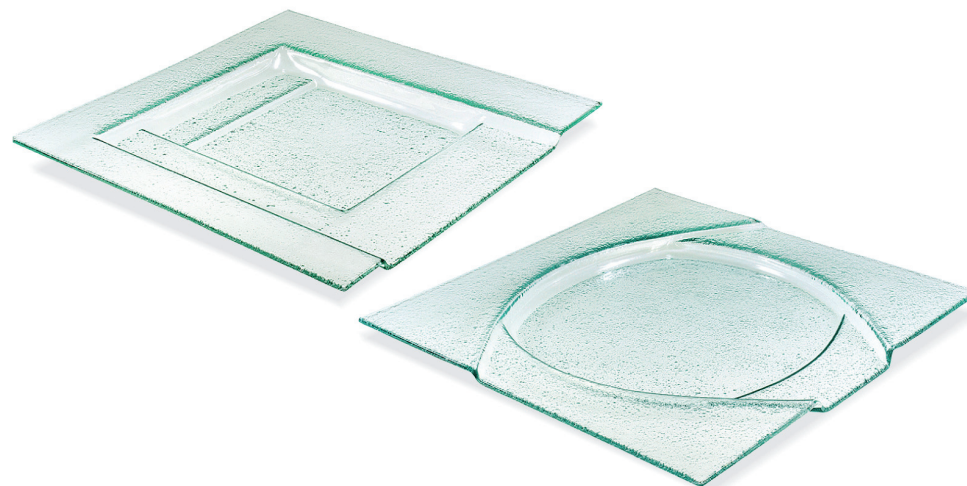
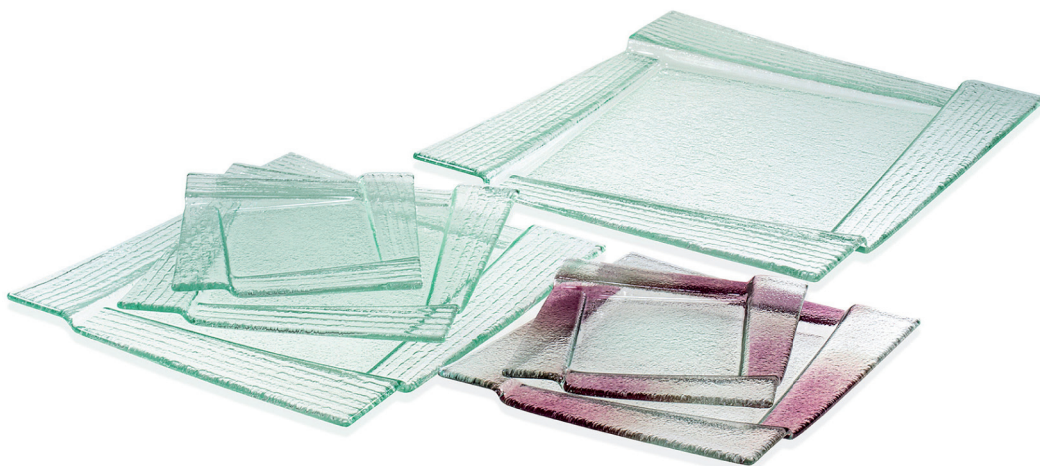

ČTVERCOVÉ TÁCY ZOOM | ZOOM SQUARE TRAYS

SERVÍROVACÍ TÁCY | SERVING TRAYS

Kód | Code **Rozměr | Size**

54511xx	15 x 15 cm
54513xx	20 x 20 cm
54515xx	26 x 26 cm
54517xx	32 x 32 cm

xx - Dvojcísli určující barvu výrobku
xx - Number of individual color

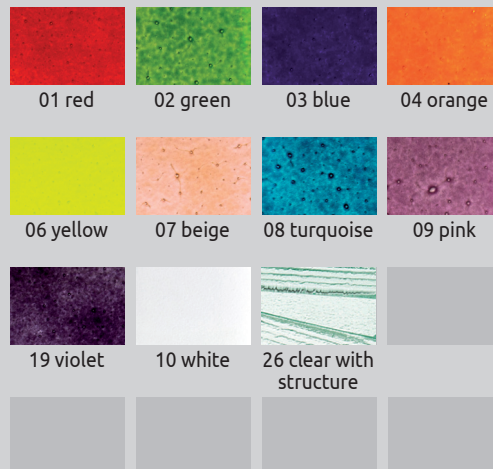

Kód | Code **Rozměr | Size**

5400xx	40 x 40 cm
--------	------------

xx - Dvojcísli určující barvu výrobku
xx - Number of individual color





TÁČY STONES | STONES TRAYS

Kód | Code **Rozměr | Size**

54301xx	26 x 15 cm
54303xx	30 x 22 cm
54304xx	30 x 30 cm
54305xx	45 x 30 cm

xx - Dvojcíslní určující barvu výrobku
xx - Number of individual color



40 extra clear



TÁČY BOND | BOND TRAYS

Kód | Code **Rozměr | Size**

54351xx	13 x 13 cm
54353xx	20 x 20 cm
54355xx	33 x 16 cm
54357xx	45 x 20 cm

xx - Dvojcíslní určující barvu výrobku
xx - Number of individual color

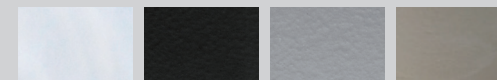

40 extra clear 22 dark grey 30 grey 50 bronze



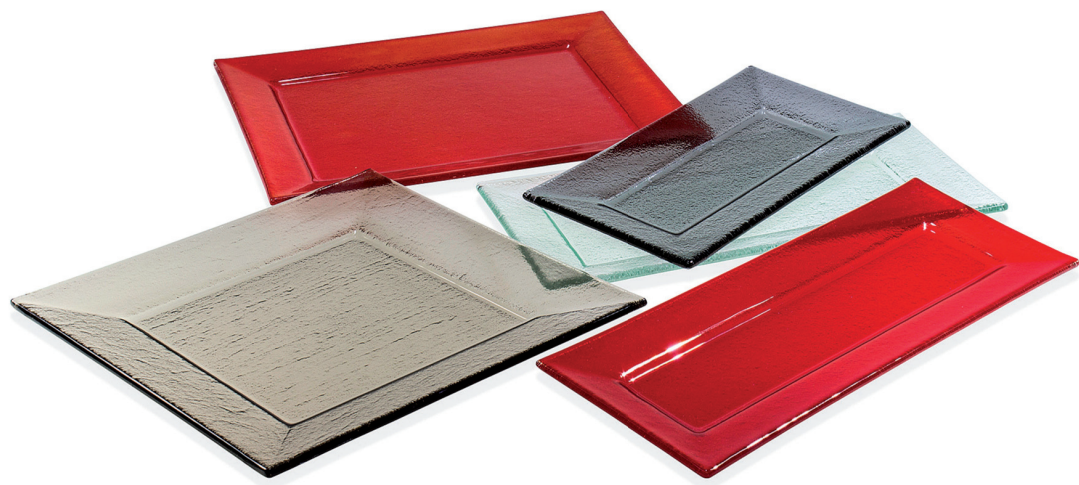

TÁČY MAXIM | MAXIM TRAYS

TÁČY LED | LED TRAYS

Kód | Code Rozměr | Size

53131xx	23 x 13 cm
53135xx	25 x 25 cm
53132xx	29 x 15 cm
53134xx	29 x 23 cm
53133xx	32 x 12 cm

xx - Dvojcísle určující barvu výrobku
xx - Number of individual color



Kód | Code Rozměr | Size

	56036x5	22 x 22 cm
	56036x4	24 x 10 cm
	56036x2	26 x 10 cm
	56036x6	28 x 13 cm
	56036x1	34 x 10 cm
	56036x3	22 x 22 cm

x - Číslice určující barvu výrobku
x - Number of individual color







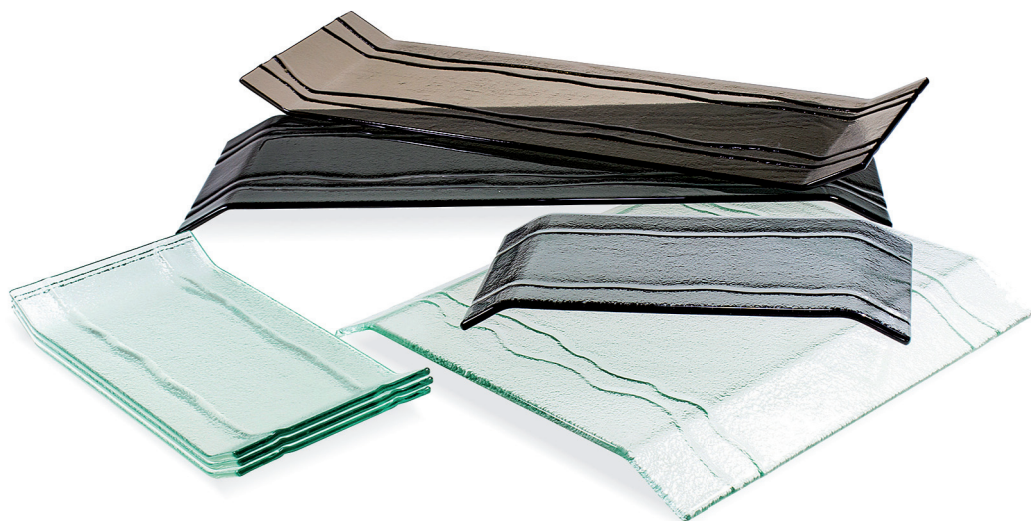

Mísy POCKET |
POCKET Bowls - str. 32



TÁCKY POCKET | POCKET TRAYS

Kód Code	Rozměr Size
 512x48	10 x 10 cm
512x04	13 x 13 cm
512x49	12 x 12 cm
512x34	14 x 14 cm
 512x05	23 x 13
 512x06	34 x 13 cm
 512x29	45 x 13 cm

x - Číslice určující barvu výrobku
x - Number of individual color

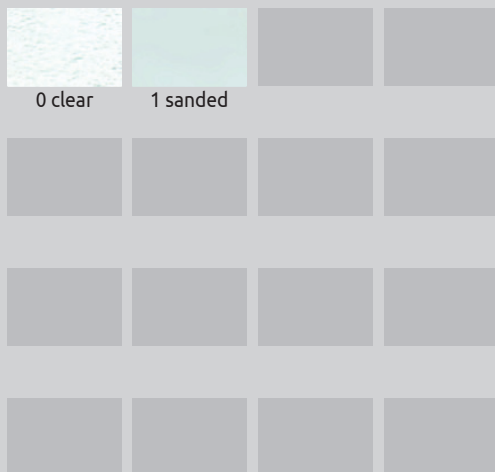

TÁČY BRIDGE | BRIDGE TRAYS

Kód Code	Rozměr Size
54111xx	24 x 12 cm
54113xx	28 x 28 cm
54112xx	45 x 15 cm

xx - Dvojcíslicí určující barvu výrobku
xx - Number of individual color

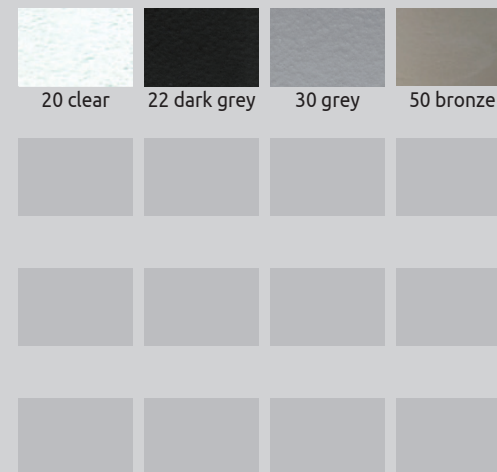

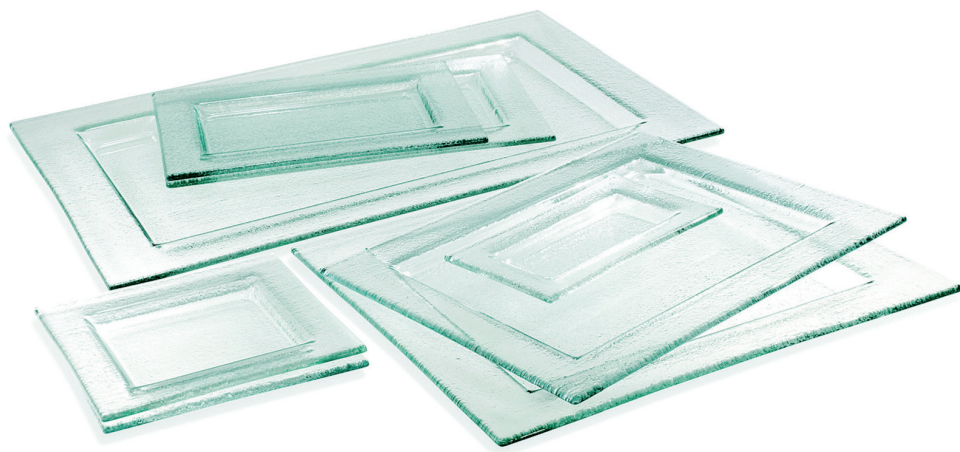

GN TÁCY | GN TRAYS (GASTRONORM)

Kód | Code **Rozměr | Size**

54611xx	10,8 x 17,6 cm
54612xx	17,6 x 16,2 cm
54613xx	26,5 x 16,3 cm
54614xx	32,5 x 17,6 cm
54615xx	32,5 x 26,5 cm
54616xx	35,4 x 32,5 cm
54617xx	53 x 32,5 cm

xx - Dvojcíslní určující barvu výrobku
xx - Number of individual color

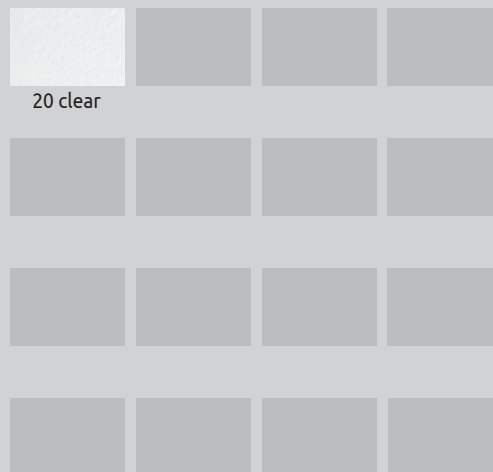

GN BAREVNÉ TÁCY | GN COLOR TRAYS

Kód | Code **Rozměr | Size**

5402xx 53 x 32,5 cm

xx - Dvojcíslní určující barvu výrobku
xx - Number of individual color

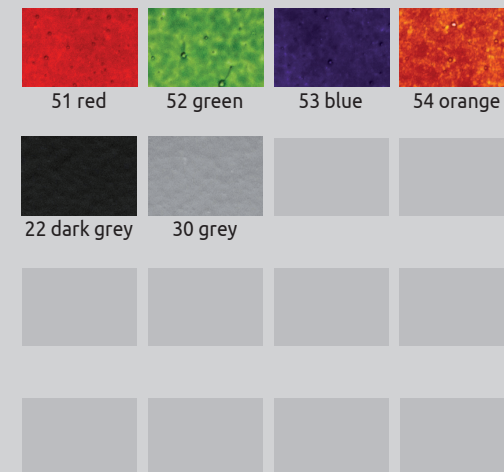

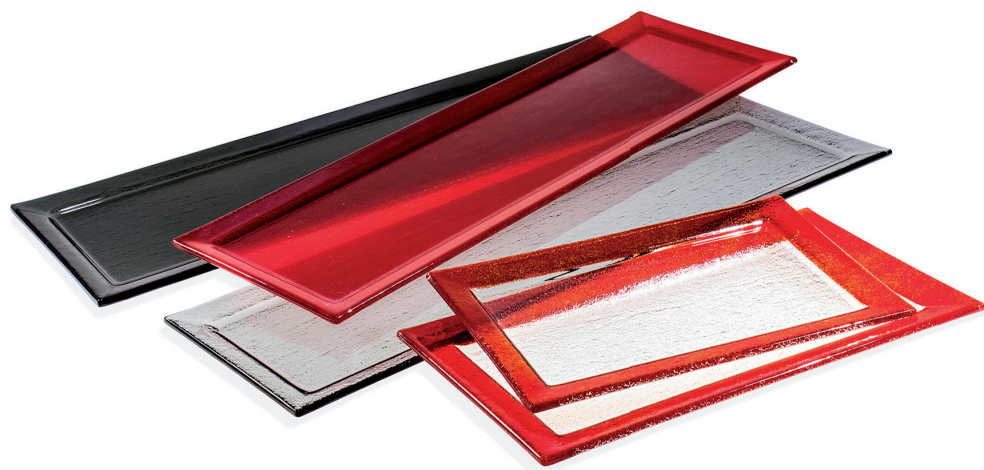

Čtvercové tácy ZOOM
I Square ZOOM Trays
str. 19



Tácy ZOOM Eye I ZOOM
Eye Trays str. 29



Kulaté Tácy ZOOM I
Round ZOOM Trays str. 28



PODNOŠY MAX GN | MAX GN TRAYS

JEDNOBAREVNÉ | FULLCOLORED

Kód | Code **Rozměr | Size**

53113xx 26,5 x 16,3 cm

53114xx 32,5 x 17,6 cm

53118xx 53 x 16,2 cm

BAREVNÝ OKRAJ | COLORED RIM

Kód | Code **Rozměr | Size**

53123xx 26,5 x 16,3 cm

53124xx 32,5 x 17,6 cm

53128xx 53 x 16,2 cm

xx - Dvojcíslní určující barvu výrobku
xx - Number of individual color

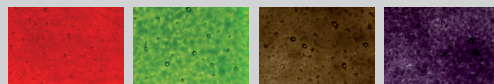

01 red 02 green 17 brown 19 violet



09 pink 10 white



JEDNOBAREVNÉ | ONLY FULL COLOR VERSION

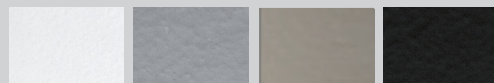

20 clear 30 grey 50 bronze 22 dark grey

OBDELNÍKOVÉ TÁCY ZOOM | ZOOM TRAYS

Kód | Code **Rozměr | Size**

54523xx 30 x 15 cm

54525xx 40 x 17 cm

54526xx 45 x 20 cm

xx - Dvojcíslní určující barvu výrobku
xx - Number of individual color

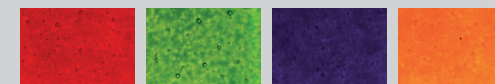

01 red 02 green 03 blue 04 orange



06 yellow 07 beige 08 turquoise 09 pink



19 violet 10 white 26 clear with structure



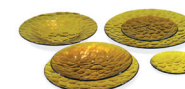
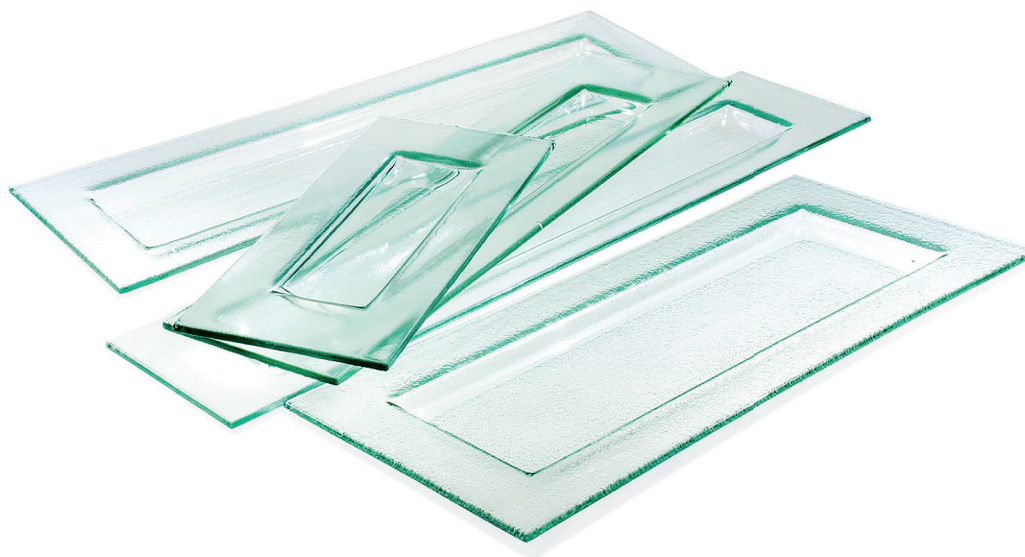

Talíře ANTIQUE I
ANTIQUÉ Plates str. 14



Talíře ANTIQUE I
ANTIQUÉ Plates str. 15

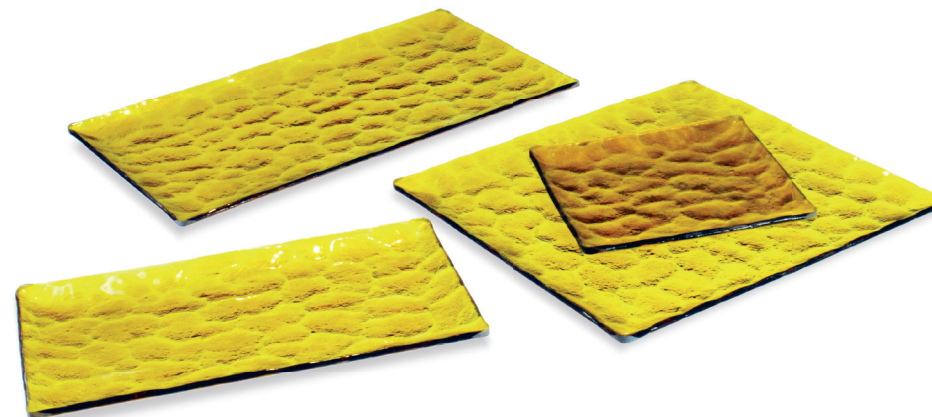

TÁČY LONG | LONG TRAYS

TÁČY ANTIQUE | ANTIQUÉ TRAYS

Kód | Code **Rozměr | Size**

51901xx	31 x 13 cm
51905xx	45 x 20 cm
51902xx	49 x 13 cm
51904xx	53 x 16 cm
51903xx	59 x 13 cm

xx - Dvojčíslí určující barvu výrobku
xx - Number of individual color

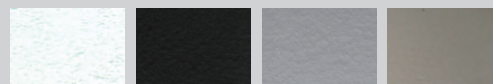

20 clear 22 dark grey 30 grey 50 bronze



Kód | Code **Rozměr | Size**

5056211	14,5 x 14,5 cm
5056231	24,5 x 14,5 cm
5056241	31 x 17,5 cm
5056261	24,5 x 24,5 cm



amber



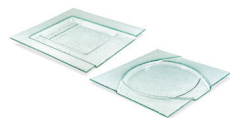

Servírovací tácy I
SERVING Trays str. 21



SERVÍROVACÍ TÁCY | SERVING TRAYS

Kód | Code **Rozměr | Size**

5400xx 50 x 35 cm

xx - Dvojcíslní určující strukturu výrobku
xx - Number of structure



03

04



TÁCY CASTLE | CASTLE TRAYS

Kód | Code **Rozměr | Size**

54343xx 38 x 18 cm

54345xx 48 x 24 cm

xx - Dvojcíslní určující barvu výrobku
xx - Number of individual color



20 clear

40 extra clear



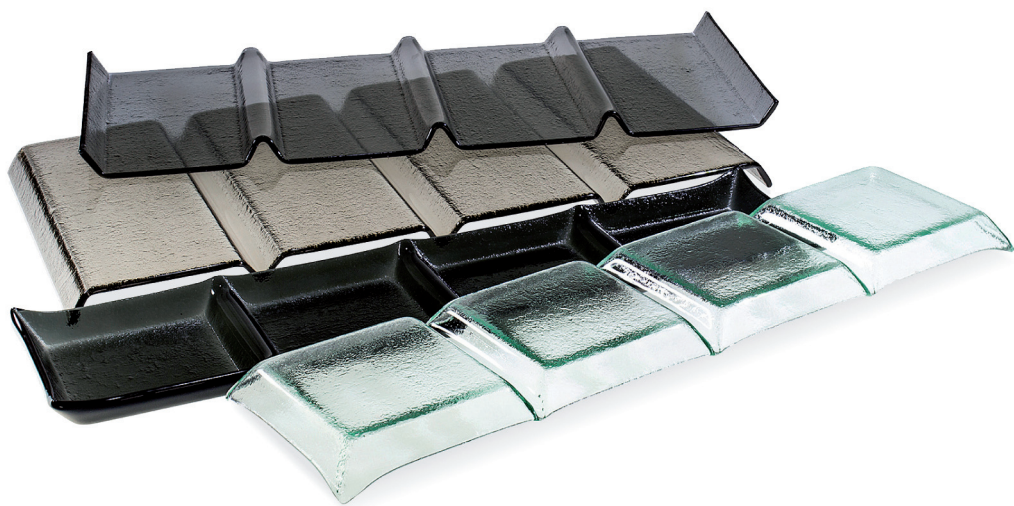

TÁČY CHOCOLATE | CHOCOLATE TRAYS

TÁČY CHOCOLATE | CHOCOLATE TRAYS

Kód | Code **Rozměr | Size**

54220xx 52 x 13 cm

54221xx 52 x 20 cm

54222xx 52 x 25 cm

xx - Dvojčíslí určující barvu výrobku
xx - Number of individual color

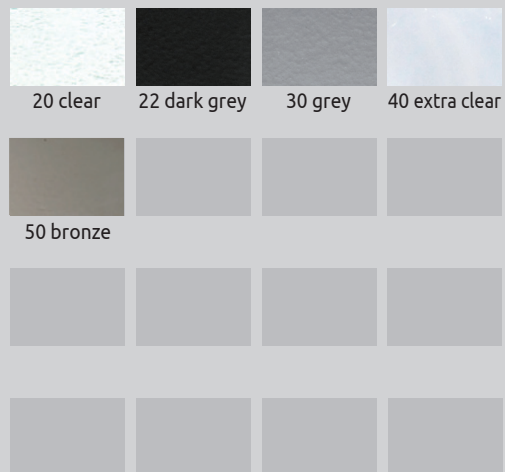

Kód | Code **Rozměr | Size**

54223xx 41 x 41 cm

xx - Dvojčíslí určující barvu výrobku
xx - Number of individual color

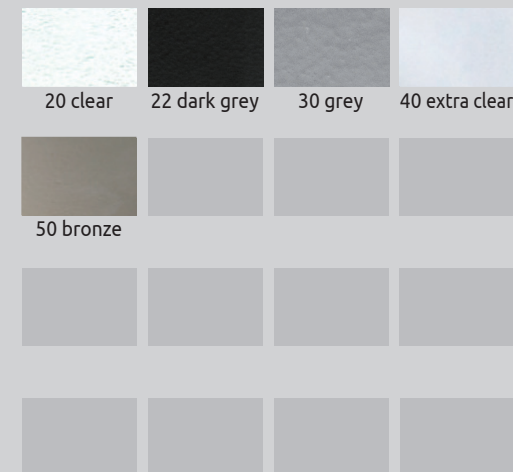

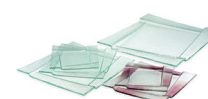

Čtvercové tácy ZOOM
I ZOOM Square Trays
str. 19



Obdelníkové tácy ZOOM
I ZOOM II. Trays str. 24



Tácy ZOOM EYE I ZOOM
EYE Trays str. 29



TÁCY TREBLE | TREBLE TRAYS

Kód | Code Rozměr | Size

54333xx ø 31 cm

54331xx 35 x 20 cm

xx - Dvočíslí určující barvu výrobku
xx - Number of individual color



KULATÉ TÁCY ZOOM | ROUND ZOOM TRAYS

Kód | Code Rozměr | Size

54501xx ø 16 cm

54503xx ø 22 cm

54504xx ø 25 cm | hloubka
depth 4 cm

54505xx ø 30 cm

54507xx ø 36 cm

xx - Dvočíslí určující barvu výrobku
xx - Number of individual color

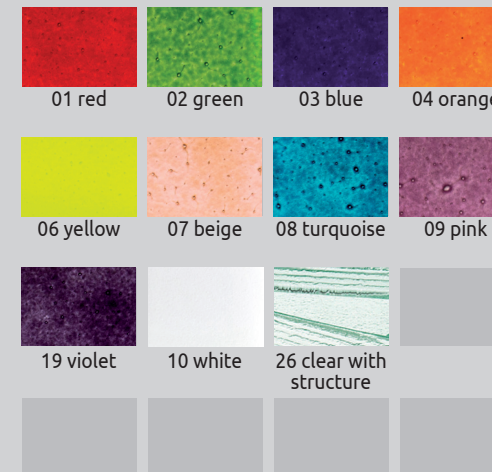

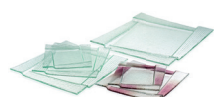

Čtvercové tácy ZOOM I
Square ZOOM Trays
str. 19

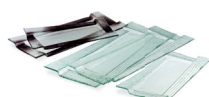

Obdelníkové tácy ZOOM I
ZOOM II. Trays str. 24



Kulaté tácy ZOOM I
Round ZOOM Trays str. 28

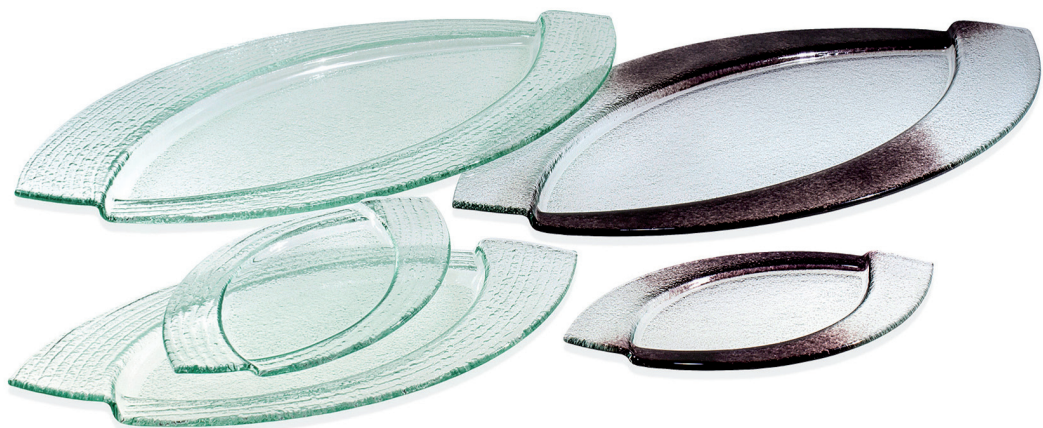

TÁCY ZOOM EYE | ZOOM EYE TRAYS

TÁCY OVAL | OVAL TRAYS

Kód | Code Rozměr | Size

54532xx 25 x 14 cm

54535xx 35 x 20 cm

54538xx 50 x 29 cm

xx - Dvojčíslí určující barvu výrobku
xx - Number of individual color

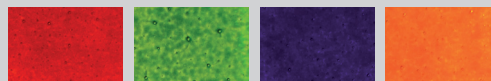

01 red 02 green 03 blue 04 orange

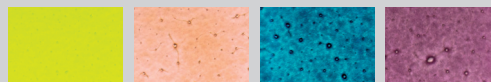

06 yellow 07 beige 08 turquoise 09 pink



19 violet 10 white 26 clear with structure



Kód | Code Rozměr | Size

54122xx 36 x 13 cm

54123xx 48 x 18 cm

54125xx 60 x 22 cm

xx - Dvojčíslí určující barvu výrobku
xx - Number of individual color



30 grey 20 clear 26 clear with structure





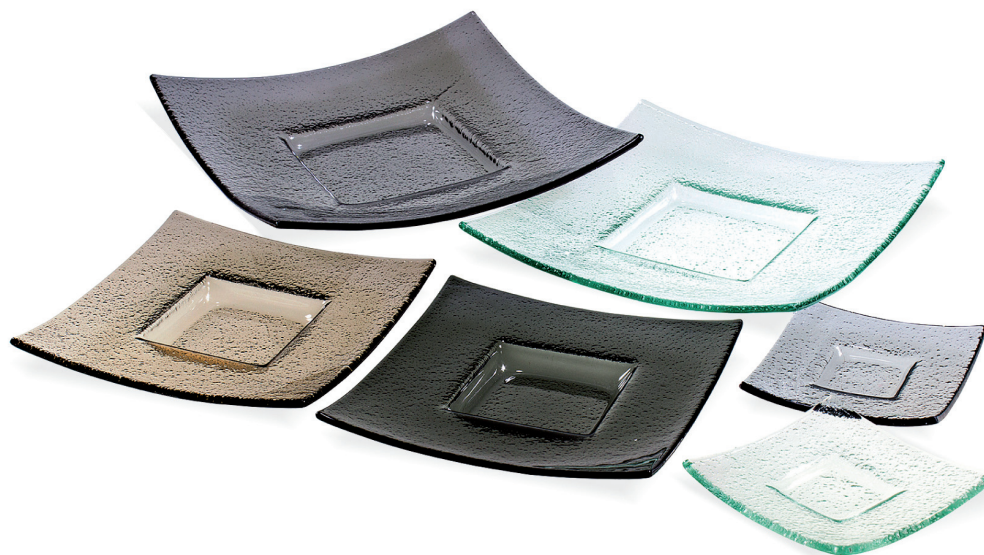

MÍSY | BOWLS
Bowls *Misy*



MÍSY ORNAMENTAL | ORNAMENTAL BOWLS

Kód Code	Rozměr Size
 505x28	30 x 30 cm hluboká deep
 505x18	30 x 30 cm mělká shallow

x - Číslice určující strukturu výrobku
x - Number of structure

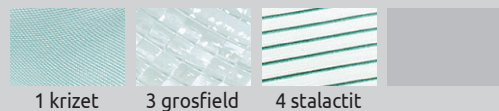

MÍSY PROLIS | PROLIS BOWLS

Kód Code	Rozměr Size
54231xx	12 x 12 cm
54233xx	20 x 20 cm
54235xx	25 x 25 cm
54237xx	30 x 30 cm
54239xx	38 x 38 cm

xx - Dvojčíslí určující barvu výrobku
xx - Number of individual color



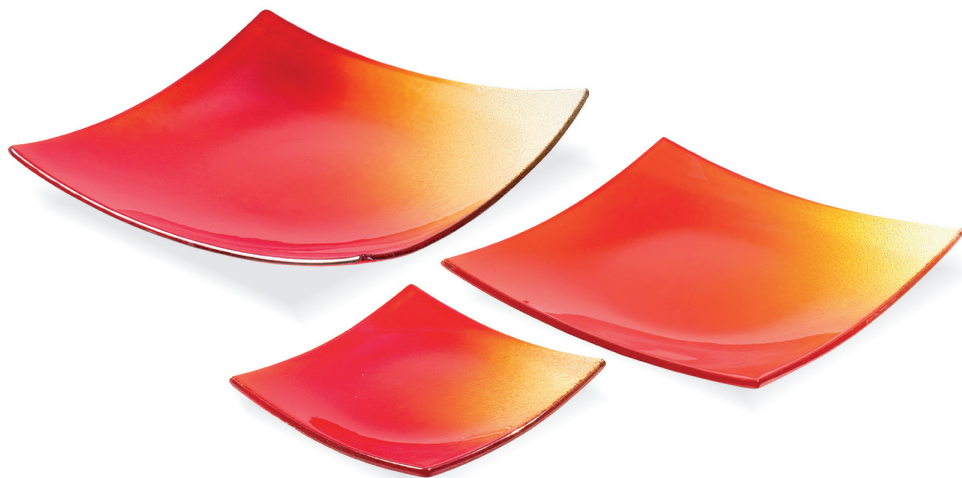

Tácy POCKET |
POCKET Trays - str. 22



MÍSY MATIZ | MATIZ BOWLS

Kód Code	Rozměr Size
5040xx	15 x 15 cm
5042xx	23 x 23 cm
5041xx	30 x 30 cm

xx - Dvojcísli určující barvu výrobku
xx - Number of individual color

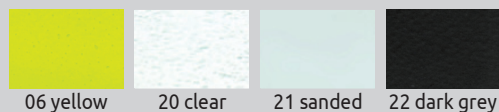
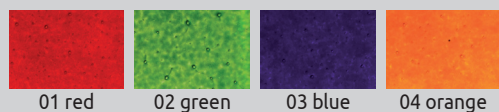

MÍSY POCKET | POCKET BOWLS

Kód Code	Rozměr Size
55053xx	23 x 23 x 1 cm
55051xx	26 x 26 x 1,5 cm
55054xx	26 x 26 x 3 cm
55052xx	30 x 30 cm x 1,5 cm
55056xx	23 x 23 x 3 cm
55055xx	26 x 26 x 1,5 cm

xx - Dvojcísli určující barvu výrobku
xx - Number of individual color

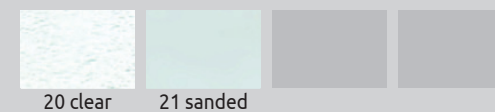

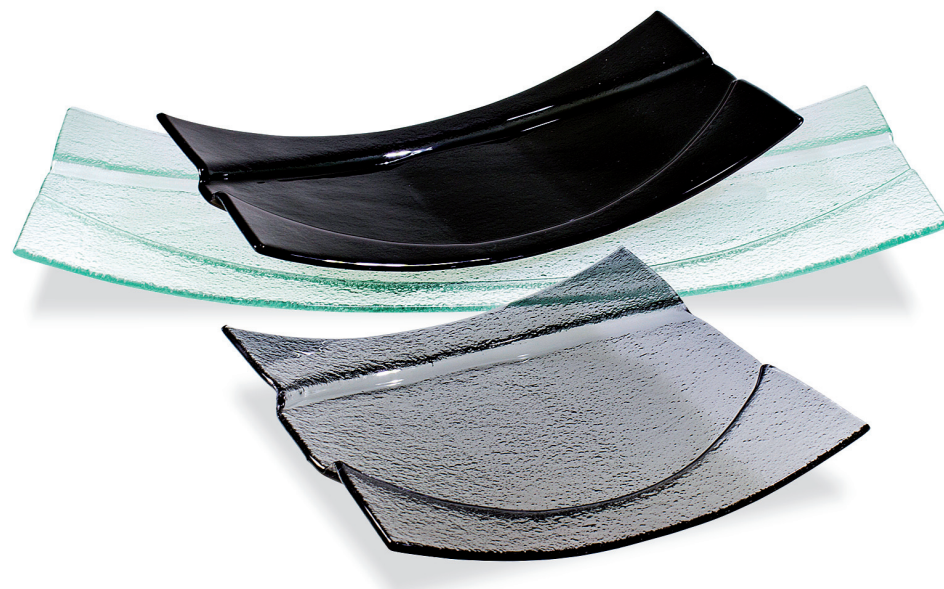

MÍSY SALAD III. | SALAD III. BOWLS

MÍSY SWING | SWING BOWLS

Kód Code	Rozměr Size
55441xx	14 x 14 cm hluboká 4 cm depth 4 cm
55442xx	19 x 19 cm hluboká 5 cm depth 5 cm

xx - Dvojčíslí určující barvu výrobku
xx - Number of individual color



Kód Code	Rozměr Size
54101xx	28 x 28 cm
54102xx	43 x 20 cm
54103xx	60 x 24 cm

xx - Dvojčíslí určující barvu výrobku
xx - Number of individual color

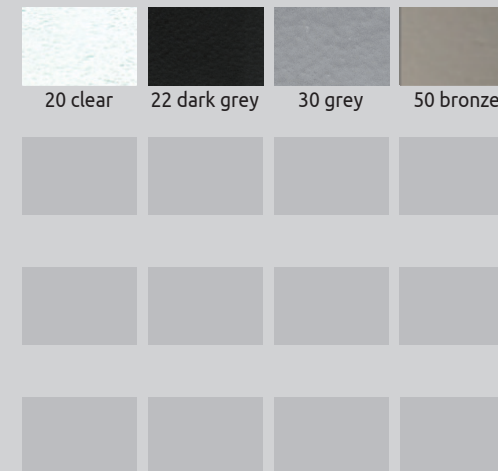

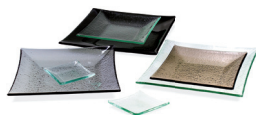

Cubo talíře |
Cubo plates str. 7

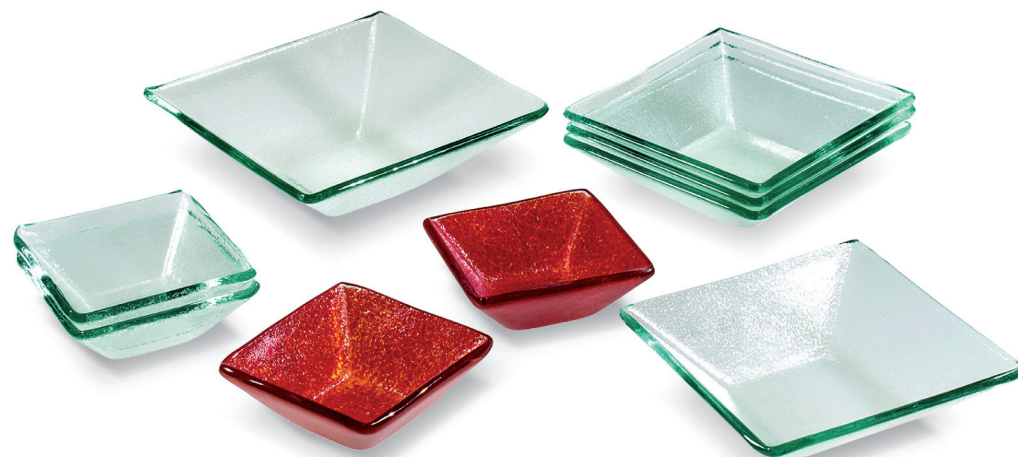
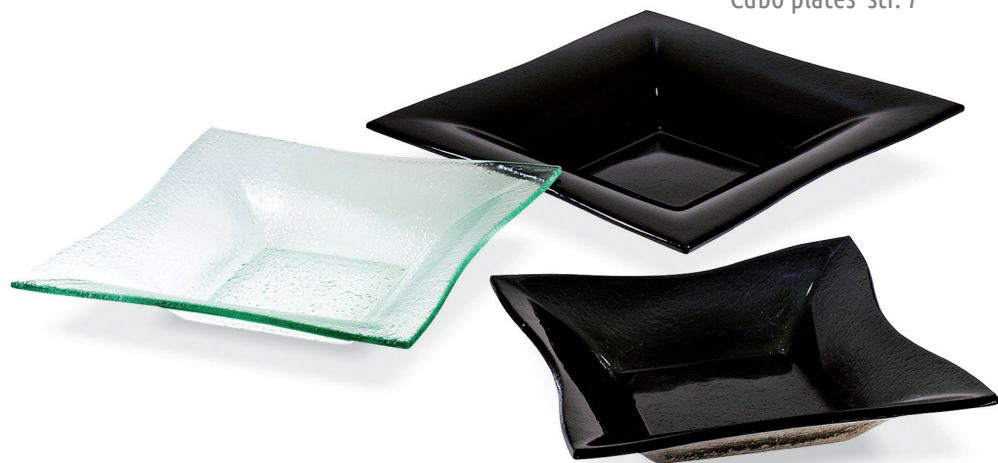

MÍSY CUBO | CUBO BOWLS

Kód | Code Rozměr | Size

5252x7 23 x 23 cm

5252x8 26 x 26 cm

5252x9 29 x 29 cm

x - Číslice určující barvu výrobku
x - Number of individual color



MÍSY SALAD I. | SALAD I. BOWLS

Kód | Code Rozměr | Size

53352xx 9 x 9 cm hluboká 3,5 cm
| depth 3,5 cm

55431xx 13 x 13 cm hluboká 3,5 cm
| depth 3,5 cm

55432xx 15 x 15 cm hluboká 4,5 cm
| depth 4,5 cm

xx - Dvojcísle určující barvu výrobku
xx - Number of individual color

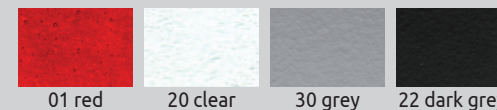



MÍSY TUBE LINKY | TUBE LINKY BOWLS

MÍSY TUBE | TUBE BOWLS

Kód | Code Rozměr | Size

54312xx 30 x 18 cm

54315xx 42 x 18 cm

54313xx 45 x 13 cm

xx - Dvojcíslní určující barvu výrobku
xx - Number of individual color



29 extra clear with black and silver lines

49 grey with black and silver lines

69 dark grey with white lines



Kód | Code Rozměr | Size

54312xx 30 x 17 cm

54313xx 45 x 13 cm

54315xx 45 x 20 cm

54317xx 48 x 23 cm

xx - Dvojcíslní určující barvu výrobku
xx - Number of individual color

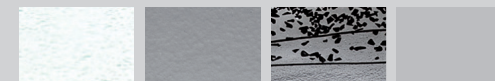

20 clear

30 grey

45 grey with black





MÍSY KAMENY | KAMENY BOWLS

Kód | Code **Rozměr | Size**

56034x2	13 x 13 cm
56034x3	19 x 11 cm
56034x7	23 x 17 cm
56034x8	23 x 23 cm
56034x9	36 x 17 cm

x - Číslice určující barvu výrobku
x - Number of individual color

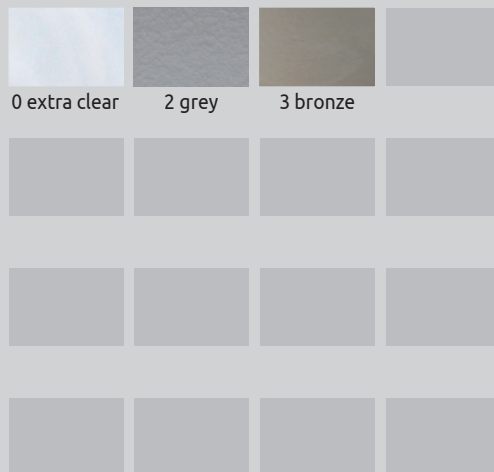

MÍSY VALENCE | VALENCE BOWLS

Kód | Code **Rozměr | Size**

51520xx	42 x 22 cm
---------	------------

xx - Dvojcíslicí určující barvu výrobku
xx - Number of individual color

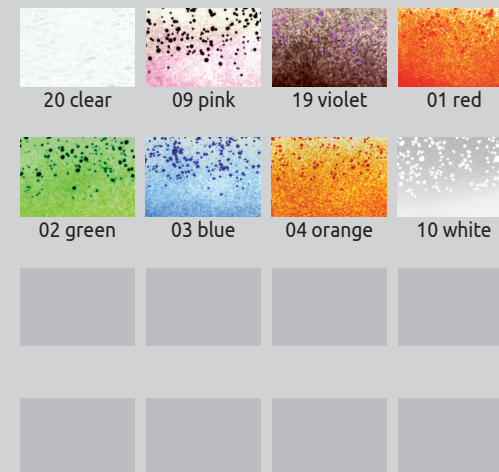



MÍSY PASTA | PASTA BOWLS

Kód | Code Rozměr | Size

54246xx ø 29 cm

xx - Dvojcísli určující barvu výrobku
xx - Number of individual color



MÍSY KISS | KISS BOWLS

Kód | Code Rozměr | Size

54451xx ø 9,5 cm

54453xx ø 16 cm

54455xx ø 20 cm

54457xx ø 32 cm

xx - Dvojcísli určující barvu výrobku
xx - Number of individual color





MÍSY LEAF | LEAF BOWLS

Kód | Code **Rozměr | Size**

5150xxx 47 x 19 cm

xxx - Trojčíslí určující barvu výrobku
xxx - Number of individual color

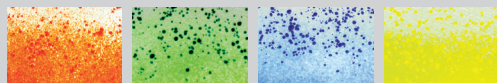

101 red 102 green 103 blue 106 yellow



109 violet 110 white 001 red 002 green



003 blue 006 yellow 020 clear 021 sanded



MÍSY PEARL | PEARL BOWLS

Kód | Code **Rozměr | Size**

 54401xx ø 15 cm

54403xx ø 18 cm

54405xx ø 32 cm

54407xx ø 36 cm

 54411xx ø 15 cm | 3 cm

54413xx ø 18 cm | 3 cm

54415xx ø 32 cm | 3 cm

54417xx ø 36 cm | 4,5 cm

xx - Dvočíslí určující barvu výrobku
xx - Number of individual color

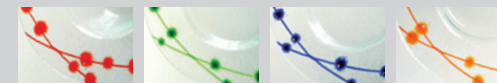

01 red 02 green 03 blue 04 orange



06 yellow 08 turquoise 09 pink 10 white

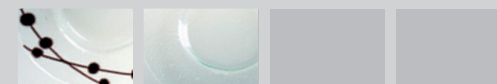

19 violet 20 clear





MÍSY SOLO | SOLO BOWLS

Kód | Code **Rozměr | Size**

243700xx ø 42 cm
hloubka 11 cm
depth 11 cm

243701xx ø 35 cm
hloubka 8,5 cm
depth 8,5 cm

243702xx ø 53 cm
hloubka 15 cm
depth 15 cm

xx - Dvojičísí určující barvu výrobku
xx - Number of individual color

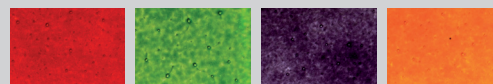

01 red 02 green 19 violet 04 orange



30 grey 20 clear



MÍSY CLOD | CLOD BOWLS

Kód | Code **Rozměr | Size**

55150xx 20 x 12 cm

xx - Dvojičísí určující barvu výrobku
xx - Number of individual color

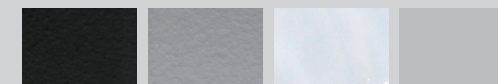

22 dark grey 30 grey 40 extra clear





SCHODY A ETAŽÉRY | STEP TRAYS

Step trays

Etažéry



RAUTOVÉ SCHODY I. | STEPS I. TRAYS

RAUTOVÉ SCHODY I. | STEPS I. TRAYS

Kód | Code Rozměr | Size

5540018 67 x 40 x 12 cm
4 stupně | 4 stairs

K rautovým schodům nabízíme skleněné podpěry podle velikosti schodů. Pro bližší informace nás prosím kontaktujte.

For STEPS Trays we also offer special glass supports according to the size of product. We can send further informations on request.



Podpěru je nutné doobjednat zvlášť.
Support must be ordered separately.

Kód | Code Rozměr | Size

5540418 67 x 40 x 12 cm
4 stupně | 4 stairs

K rautovým schodům nabízíme skleněné podpěry podle velikosti schodů. Pro bližší informace nás prosím kontaktujte.

For STEPS Trays we also offer special glass supports according to the size of product. We can send further informations on request.



Podpěru je nutné doobjednat zvlášť.
Support must be ordered separately.





RAUTOVÉ SCHODY I. | STEPS I. TRAYS

Kód | Code **Rozměr | Size**

540019 65 x 40 x 20 cm
7 stupňů | 7 stairs

K rautovým schodům nabízíme skleněné podpěry podle velikosti schodů. Pro bližší informace nás prosím kontaktujte.

For STEPS Trays we also offer special glass supports according to the size of product. We can send further informations on request.



Podpěru je nutné doobjednat zvlášť.
Support must be ordered separately.

RAUTOVÉ SCHODY I. | STEPS I. TRAYS

Kód | Code **Rozměr | Size**

540419 65 x 40 x 20 cm
7 stupňů | 7 stairs

K rautovým schodům nabízíme skleněné podpěry podle velikosti schodů. Pro bližší informace nás prosím kontaktujte.

For STEPS Trays we also offer special glass supports according to the size of product. We can send further informations on request.



Podpěru je nutné doobjednat zvlášť.
Support must be ordered separately.



RAUTOVÉ SCHODY PYRAMIDA | PYRAMIDA TRAYS

TÁCKY CANAPÉ I. | CANAPÉ TRAYS I.

Kód | Code **Rozměr | Size**

540x40 40 x 40 cm

x - Číslice určující barvu výrobku
x - Number of individual color

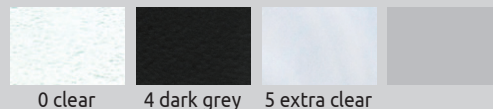

K rautovým schodům nabízíme skleněné podpěry podle velikosti schodů. Pro bližší informace nás prosím kontaktujte.

For STEPS Trays we also offer special glass supports according to the size of product. We can send further informations on request.



Podpěru je nutné doobjednat zvlášť.
Support must be ordered separately.

Kód | Code **Rozměr | Size**

50103xx 10 x 10 cm

xx - Dvojcíslicí určující barvu výrobku
xx - Number of individual color





RAUTOVÉ SCHODY II. | STEPS II. TRAYS

Kód | Code **Rozměr | Size**

540x21 88 x 48 x 10 cm

x - Číslice určující barvu výrobku
x - Number of individual color

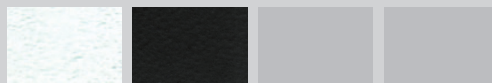

0 clear 4 dark grey

K rautovým schodům nabízíme skleněné podpěry podle velikosti schodů. Pro bližší informace nás prosím kontaktujte.

For STEPS Trays we also offer special glass supports according to the size of product. We can send further informations on request.



Podpěru je nutné doobjednat zvlášť.
Support must be ordered separately.

RAUTOVÉ SCHODY II. | STEPS II. TRAYS

Kód | Code **Rozměr | Size**

540x22 83 x 48 x 12 cm

x - Číslice určující barvu výrobku
x - Number of individual color

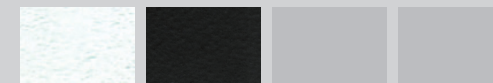

0 clear 4 dark grey

K rautovým schodům nabízíme skleněné podpěry podle velikosti schodů. Pro bližší informace nás prosím kontaktujte.

For STEPS Trays we also offer special glass supports according to the size of product. We can send further informations on request.



Podpěru je nutné doobjednat zvlášť.
Support must be ordered separately.

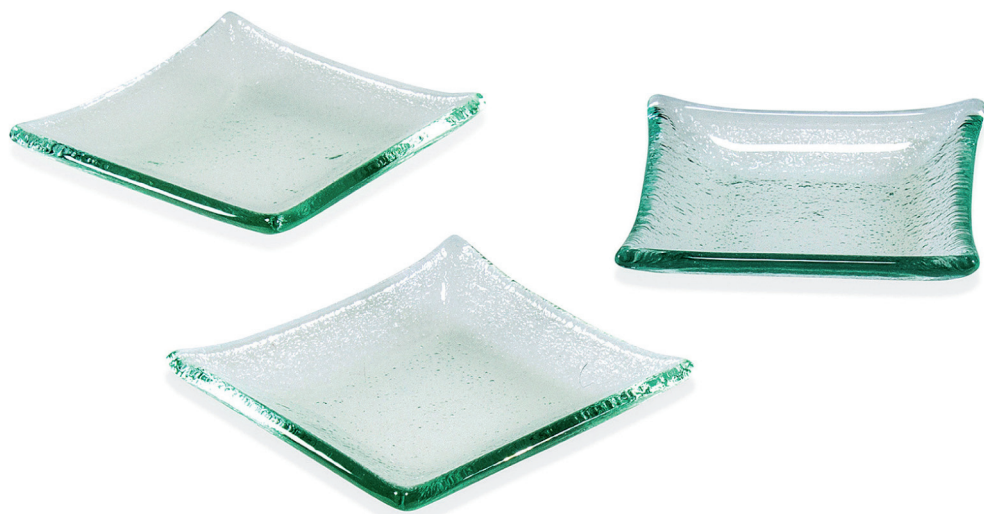

TÁCKY CANAPÉ IV. | CANAPÉ TRAYS IV.

Kód | Code Rozměr | Size

53351xx 10 x 10 cm

xx - Dvojcíslní určující barvu výrobku
xx - Number of individual color



Kód | Code Rozměr | Size

50112xx 7 x 7 cm

xx - Dvojcíslní určující barvu výrobku
xx - Number of individual color





TÁCKY CANAPÉ II. | CANAPÉ TRAYS II.

Kód | Code **Rozměr | Size**

50101xx 8 x 6 cm

xx - Dvojičíslo určující barvu výrobku
xx - Number of individual color

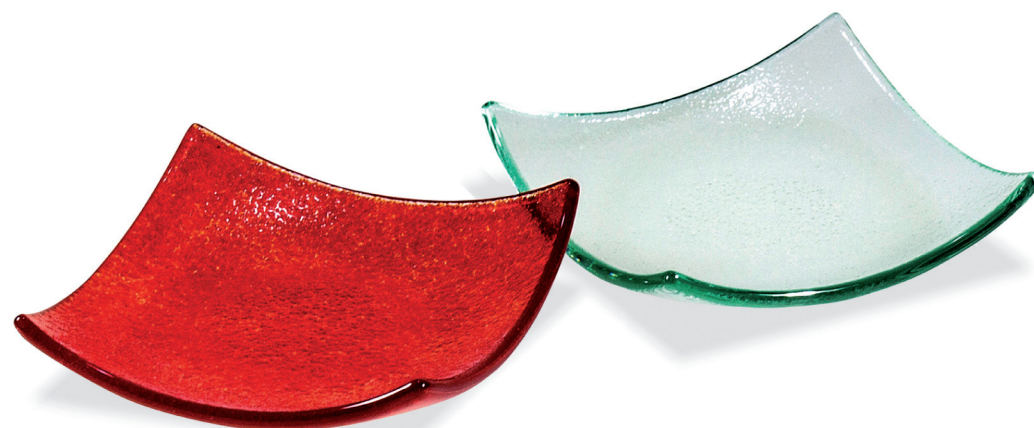

TÁCKY CANAPÉ VII. | CANAPÉ TRAYS VII.

Kód | Code **Rozměr | Size**

50116xx 10 x 10 cm

xx - Dvojičíslo určující barvu výrobku
xx - Number of individual color





TÁCKY CANAPÉ VIII. | CANAPÉ TRAYS VIII.

Kód | Code **Rozměr | Size**

50117xx 18 x 5 cm

xx - Dvojčíslí určující barvu výrobku
xx - Number of individual color



MISKY ALADIN | ALADIN BOWLS

Kód | Code **Rozměr | Size**

50133xx 28 x 15 cm

xx - Dvojčíslí určující barvu výrobku
xx - Number of individual color





MISKY SOJA | SOJA BOWLS

Kód | Code **Rozměr | Size**

246001xx ø 6 cm hloubka 4,5 cm |
depth 4,5 cm

246002xx ø 7 cm hloubka 4,5 cm |
depth 4,5 cm

xx - Dvojcísli určující barvu výrobku
xx - Number of individual color

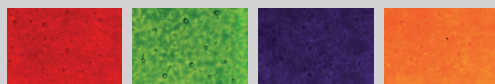

01 red 02 green 03 blue 04 orange



19 violet 20 clear 22 dark grey 30 grey



MISKY WINKY | WINKY BOWLS

Kód | Code **Rozměr | Size**

50121xx ø 8 cm hloubka 3,5 cm |
depth 3,5 cm

50122xx 8 x 8 cm hloubka 4 cm |
depth 4 cm

50123xx 10 x 10 cm hloubka 5 cm
| depth 5 cm

xx - Dvojcísli určující barvu výrobku
xx - Number of individual color

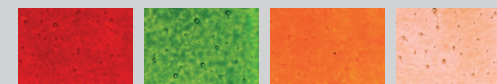

01 red 02 green 04 orange 07 beige

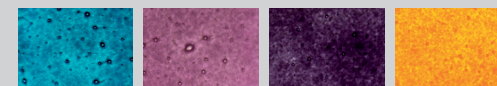

08 turquoise 09 pink 19 violet 36 light amber



30 grey 20 clear





ETAŽÉR NA DORT | CAKE WHATNOT

ETAŽÉR VELO | VELO CAKE WHATNOT

Kód | Code Rozměr | Size

55125xx ø 28 cm
 Výška | hight 7 cm
 nebo | or
 výška | hight 12 cm

55126xx ø 33 cm
 Výška | hight 7 cm
 nebo | or
 výška | hight 12 cm

xx - Dvojcíslní určující barvu výrobku
 xx - Number of individual color



Kód | Code Rozměr | Size

55122xx ø 22 cm
 Výška | hight 7 cm
 nebo | or
 výška | hight 12 cm

55123xx ø 28 cm
 Výška | hight 7 cm
 nebo | or
 výška | hight 12 cm

xx - Dvojcíslní určující barvu výrobku
 xx - Number of individual color

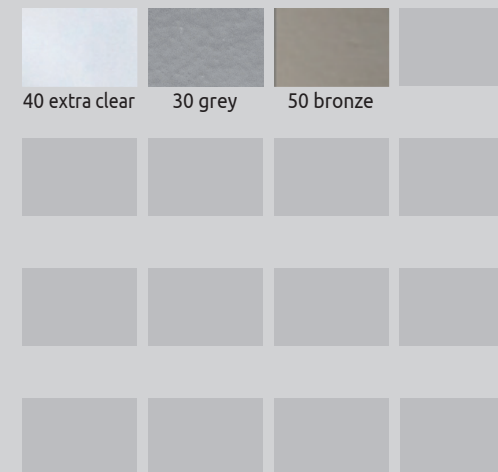

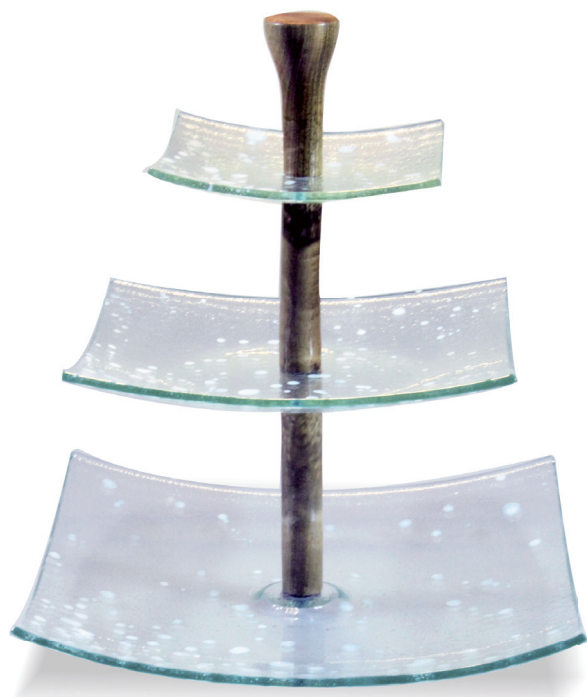

ETAŽÉR MATIZ | MATIZ CAKE 3-STOREY WHATNOT

Kód | Code **Rozměr | Size**

55121xx Talíře | Plates:
30 x 30 cm
20 x 20 cm
15 x 15 cm
Výška | Hight 28 cm

xx - Dvojcíslní určující barvu výrobku
xx - Number of individual color



10 white 19 violet



ETAŽÉR VELO | VELO CAKE 3-STOREY WHATNOT

Kód | Code **Rozměr | Size**

55120xx Talíře | Plates:
ø 32 cm
ø 25 cm
ø 20 cm
Výška | Hight 30 cm

xx - Dvojcíslní určující barvu výrobku
xx - Number of individual color

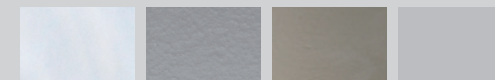

40 extra clear 30 grey 50 bronze



SVÍCNY | CANDLESTICKS

Candlesticks *Svícný*





SVÍČNY FLOWER | FLOWER CANDLESTICKS

Kód | Code **Rozměr | Size**

61x181 10 x 10 cm

610xxx 10 x 10 cm

x - Číslice určující barvu výrobku
x - Number of individual color

xxx - Trojčíslí určující barvu výrobku
xxx - Number of individual color

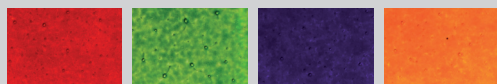

901 red 902 green 903 blue 904 orange

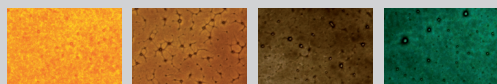

907 light amber 908 amber 909 dark amber 912 dark green



913 light blue 921 silver 920 gold 922 cooper

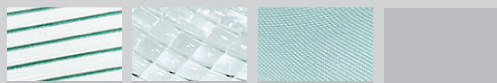

804 stalactit 803 grosfield 801 krizet



0 clear 1 sanded



SVÍČNY FLY | FLY CANDLESTICKS

Kód | Code **Rozměr | Size**

54160xx 34 x 13 cm

xx - Dvočíslí určující barvu výrobku
xx - Number of individual color

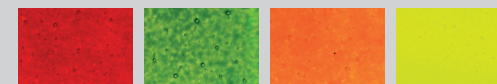

01 red 02 green 04 orange 06 yellow



07 beige 08 turquoise 09 pink 12 dark green

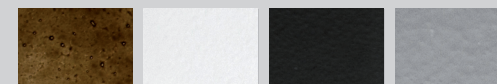

17 brown 10 white 22 dark grey 30 grey



20 clear

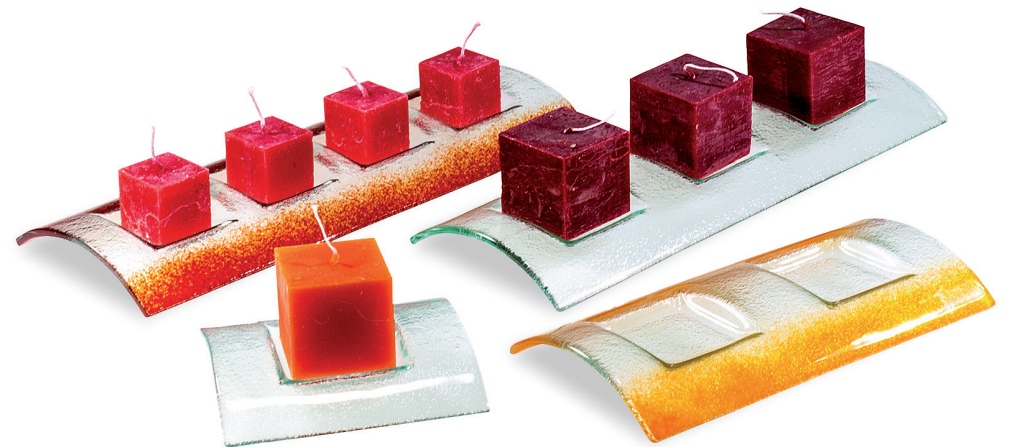

SVÍCNY FLY LINKY | FLY LINKY CANDLESTICKS

SVÍCNY TUNNEL | TUNNEL CANDLESTICKS

Kód | Code Rozměr | Size

54160xx 34 x 13 cm

xx - Dvojčíslí určující barvu výrobku
xx - Number of individual color



29 extra clear
with black and
silver lines

49 grey with
black and
silver lines

69 dark grey
with white
lines



Kód | Code Rozměr | Size

65101xx 13 x 13 cm

65102xx 23 x 13 cm

65103xx 34 x 13 cm | 3 svíčky
3 candles

65104xx 34 x 13 cm | 4 svíčky
4 candles

xx - Dvojčíslí určující barvu výrobku
xx - Number of individual color



01 red

02 green

03 blue

04 orange

06 yellow

07 beige

08 turquoise

09 pink

10 white

12 dark green

17 brown

19 violet

20 clear





SVÍCNY TUNNEL LINKY | TUNNEL LINKY CANDLESTICKS

Kód | Code **Rozměr | Size**

65101xx 13 x 13 cm

65104xx 34 x 13 cm

xx - Dvojcíslný určující barvu výrobku
xx - Number of individual color

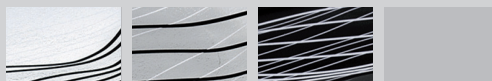

29 extra clear
with black and
silver lines

49 grey with
black and
silver lines

69 dark grey
with white
lines



SVÍCNY TRIANGLE | TRIANGLE BOWLS

Kód | Code **Rozměr | Size**

53810xx 20 x 20 x 20 cm

xx - Dvojcíslný určující barvu výrobku
xx - Number of individual color

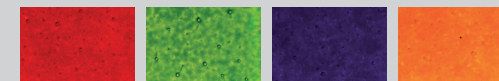

01 red

02 green

03 blue

04 orange



06 yellow

08 turquoise

09 pink

10 white

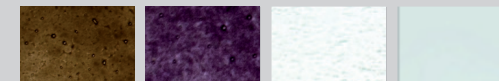

17 brown

19 dark violet

20 clear

21 sanded



36 light amber

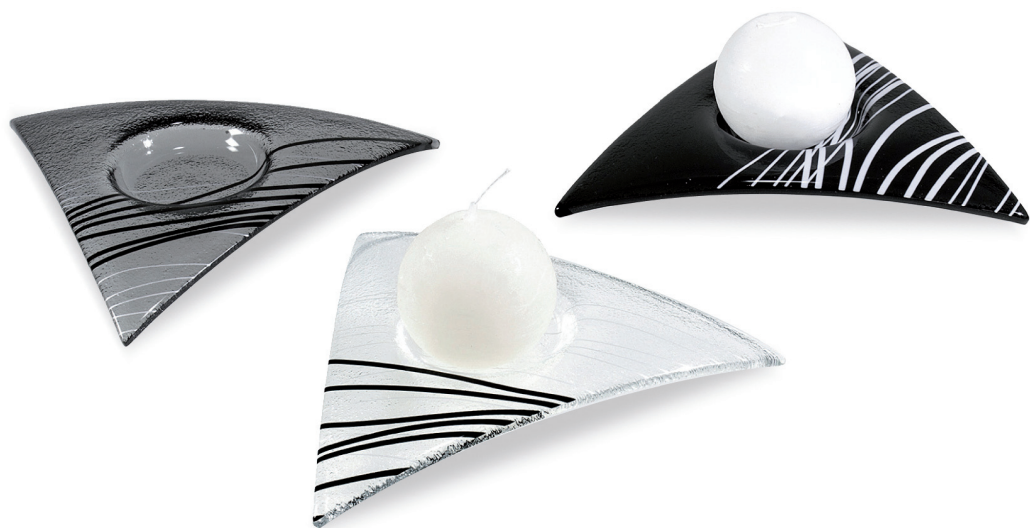

SVÍČNY TRIANGLE LINKY | TRIANGLE LINKY BOWLS

Kód | Code Rozměr | Size

53810xx 20 x 20 x 20 cm

xx - Dvojcísli určující barvu výrobku
xx - Number of individual color



29 extra clear
with black and
silver lines

49 grey with
black and
silver lines

69 dark grey
with white
lines



SVÍČNY PALMER | PALMER CANDLESTICKS

Kód | Code Rozměr | Size

□□□ 54188xx 30 x 12 cm

□□□□ 54189xx 36 x 12 cm

xx - Dvojcísli určující barvu výrobku
xx - Number of individual color

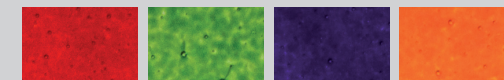

01 red

02 green

03 blue

04 orange

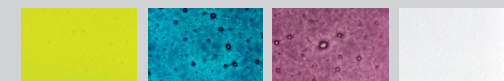

06 yellow

08 turquoise

09 pink

10 white

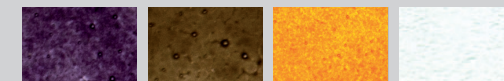

19 violet

17 brown

36 light
amber

20 clear

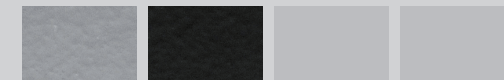

30 grey

22 dark grey





SVÍČNY PALMER | PALMER CANDLESTICKS

Kód | Code Rozměr | Size

54183xx 27 x 10 cm

54184xx 33 x 10 cm

xx - Dvojcíslní určující barvu výrobku
xx - Number of individual color

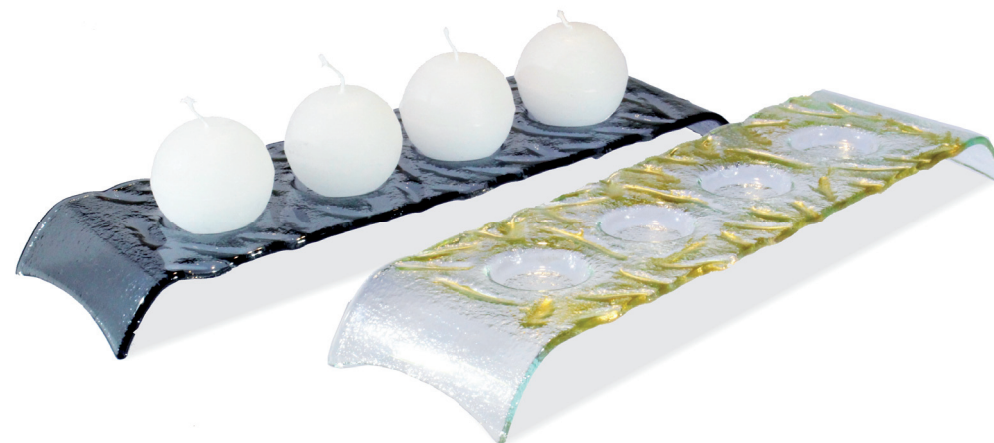

SVÍČNY LED TUNNEL | LED TUNNEL CANDLESTICKS

Kód | Code Rozměr | Size

56036xx 39 x 10 cm

xx - Dvojcíslní určující barvu výrobku
xx - Number of individual color

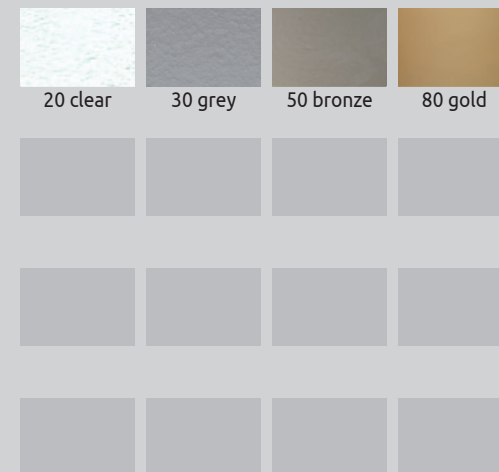

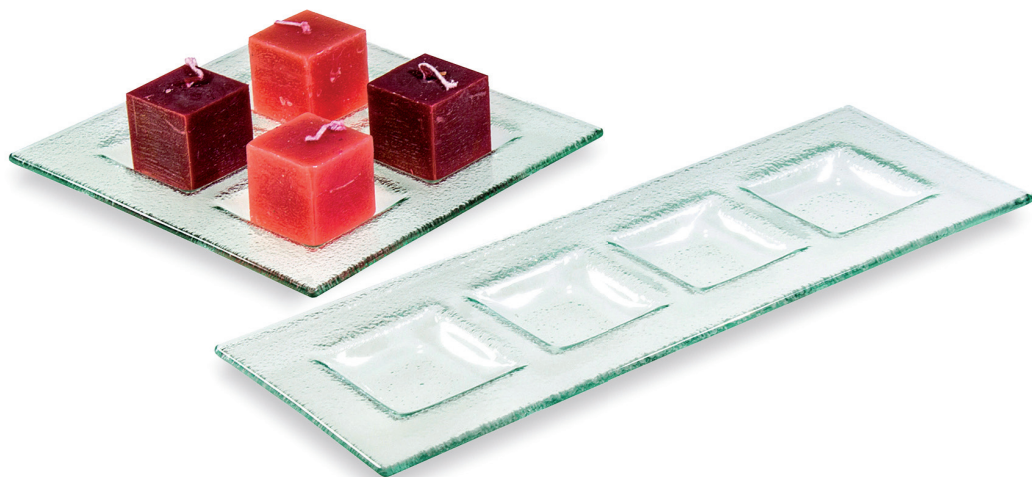

SVÍCNY ADVENT | ADVENT TRAYS

Kód | Code Rozměr | Size

5336x1 17,5 x 17,5 cm

5336x2 31,5 x 11 cm

x - Číslice určující barvu výrobku
x - Number of individual color



0 clear

1 grey



SVÍCNY BOAT | BOAT CANDLESTICKS

Kód | Code Rozměr | Size

64011xx 15 x 12 cm

64012xx 24 x 12 cm

64013xx 31 x 12 cm

xx - Dvojčíslí určující barvu výrobku
xx - Number of individual color

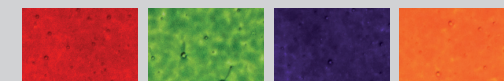

01 red

02 green

03 blue

04 orange

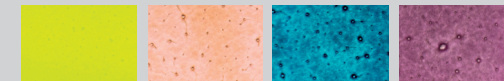

06 yellow

07 beige

08 turquoise

09 pink

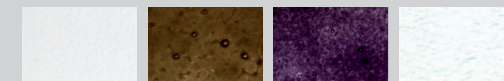

10 white

17 brown

19 violet

20 clear



22 dark grey





SVÍČNY ANGEL | ANGEL CANDLESTICKS

Kód Code	Rozměr Size
223010xx	výška height: 12 cm křídla nahoru wings up bílé šaty white dress
223015xx	výška height: 14 cm křídla dolů wings down bílé šaty white dress
223013xx	výška height: 12 cm křídla nahoru wings up barevné šaty color dress
223018xx	výška height: 14 cm křídla dolů wings down barevné šaty color dress

xx - Dvojičíslo určující barvu výrobku
xx - Number of individual color

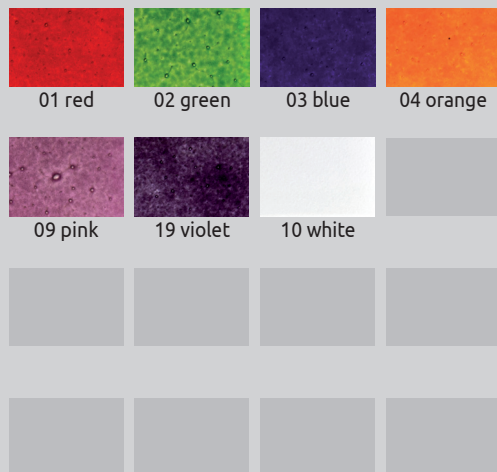

SVÍČNY LEAF | LEAF CANDLESTICKS

Kód Code	Rozměr Size
61040xx	8 x 9 cm
61041xx	12 x 17 cm
61042xx	15 x 16 cm
61031xx	18 x 8,5 cm
61030xx	12 x 8,5 cm
61032xx	30 x 10 cm

xx - Dvojičíslo určující barvu výrobku
xx - Number of individual color

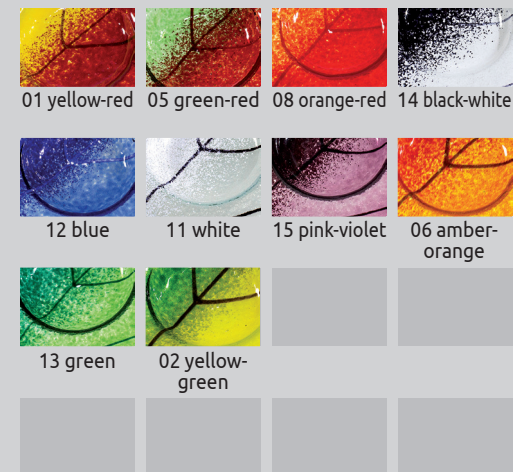



SVÍČNY FISH | FISH CANDLESTICKS

Kód Code	Rozměr Size
61051xx	17 x 8 cm
61052xx	23 x 9 cm
61053xx	30 x 10 cm

xx - Dvojcíslní určující barvu výrobku
xx - Number of individual color



SVÍČNY COSMOS | COSMOS CANDLESTICKS

Kód Code	Rozměr Size
5248xx	ø 29 cm
5247xx	ø 18 cm

xx - Dvojcíslní určující barvu výrobku
xx - Number of individual color

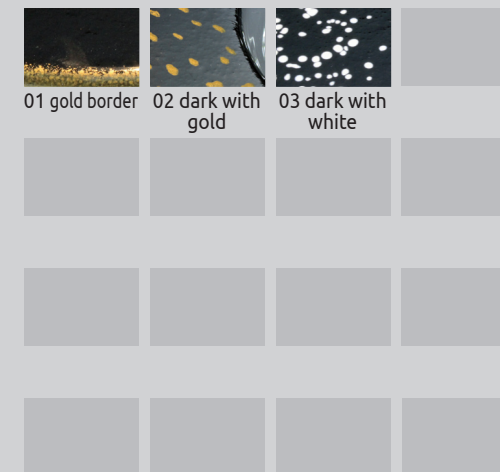



SVÍCNÝ VLOČKA | SNOWFLAKES CANDLESTICKS

Kód | Code **Rozměr | Size**

51540xx 10 x 10 cm

xx - Dvojcíslný určující barvu výrobku
xx - Number of individual color



03 dark grey
with white



04 clear with
white



SVÍCNÝ CANDY | CANDY CANDLESTICKS

Kód | Code **Rozměr | Size**

515401xx 10 x 10 cm

xx - Dvojcíslný určující barvu výrobku
xx - Number of individual color

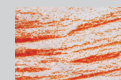

01 red



02 green

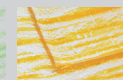

04 orange



08 turquoise



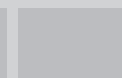
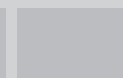
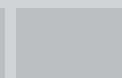
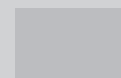
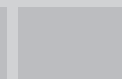
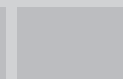
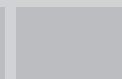
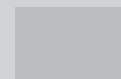
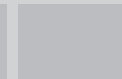
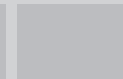
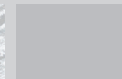

10 white





SVÍCNÝ LEAF DECAL | LEAF DECAL CANDLESTICKS

Kód Code	Rozměr Size
 61061xx 16 x 8 cm	
 61062xx 19 x 10 cm	
 61063xx 28 x 13 cm	

xx - Dvojčíslí určující barvu výrobku
xx - Number of individual color



01 gold 02 african brown 03 green 04 turquoise



4-POZICOVÉ SVÍCNÝ FLY | 4 POSITION FLY CANDLESTICKS

Kód Code	Rozměr Size
54162xx	38 x 13 cm

xx - Dvojčíslí určující barvu výrobku
xx - Number of individual color



29 extra clear with black and silver lines 49 grey with black and silver lines 69 dark grey with white lines 50 clear with colored spots



60 grey with colored spots





DEKORACE | DECORATIONS
Decorations *Dekorace*



DEKORATIVNÍ ANDĚLÉ | DECORATIVE ANGELS

Kód Code	Rozměr Size
111300100	12 x 20 cm - A
111300300	13 x 25 cm - C

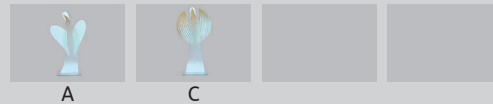

DEKORATIVNÍ KOČKY | DECORATIVE CATS

Kód Code	Rozměr Size
11101x1	16 x 8 cm - A
11101x2	20 x 12 cm - B
11101x3	13 x 14 cm - C
11101x4	10 x 14 cm - D
11101x5	8 x 22 cm - E
11101x6	8 x 20 cm - F

x - Číslice určující barvu výrobku
x - Number of individual color

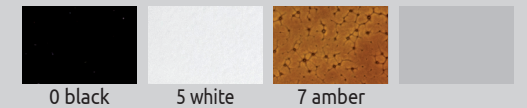

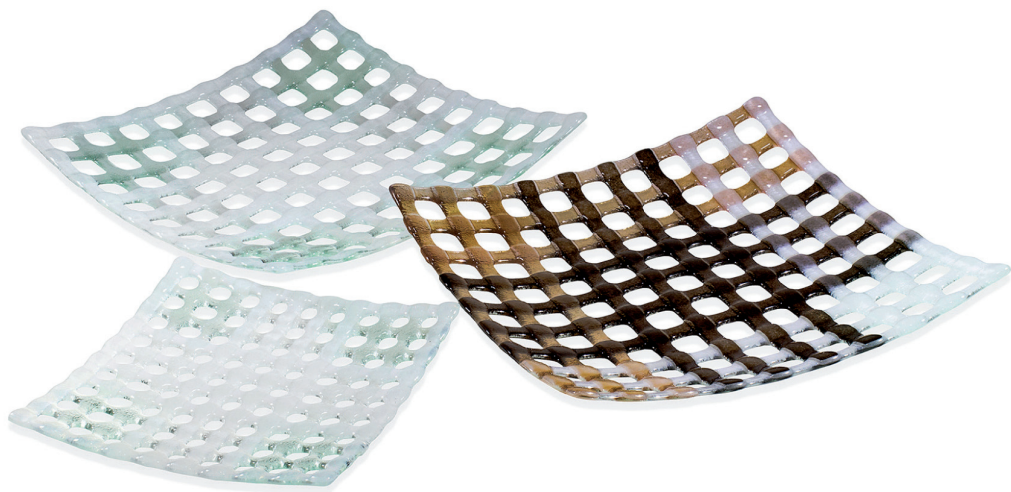

MÍSY NET | NET BOWLS

Kód | Code **Rozměr | Size**

5082xx 20 x 20 cm

5083xx 30 x 30 cm

xx - Dvočíslí určující barvu výrobku
xx - Number of individual color

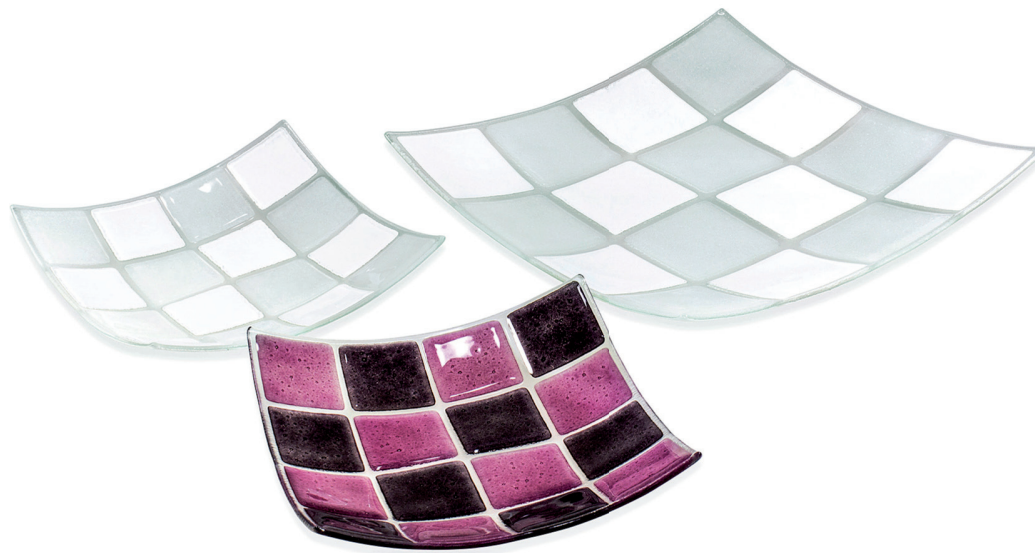

MÍSY KARO | KARO BOWLS

Kód | Code **Rozměr | Size**

5143xx 15 x 15 cm

5142xx 20 x 20 cm

5141xx 30 x 30 cm

xx - Dvočíslí určující barvu výrobku
xx - Number of individual color

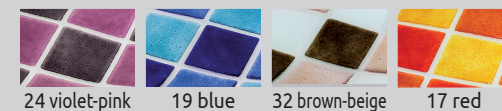



Barevný vzorník BDK-GLASS | Range of colors in BDK-GLASS production

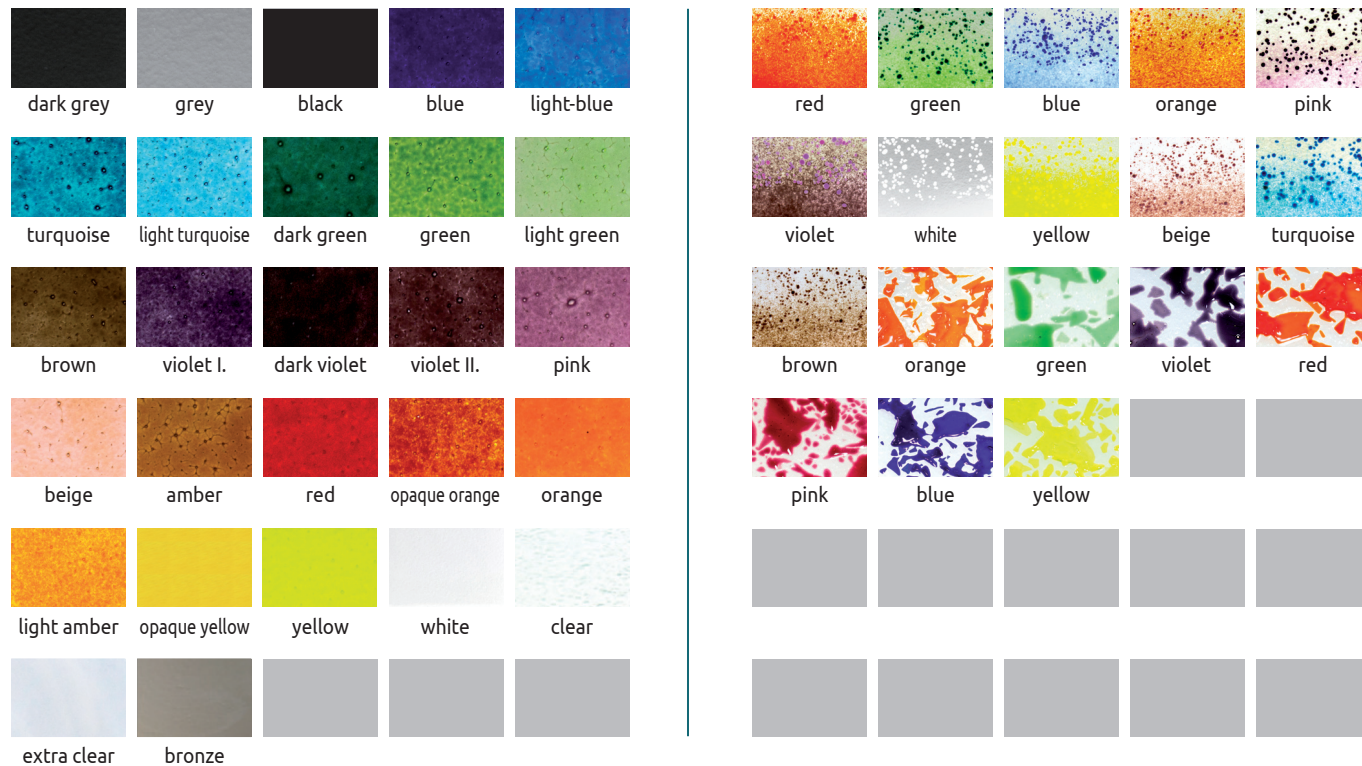

Barvy skla: dark grey (tmavě šedá), grey (šedá), clear (čirá), extra clear (extra čirá) a bronze (bronzová) jsou barevné ve hmotě. Ostatní barvy jsou pouze skleněné frity a lze je tedy použít k dekorování i částí výrobků (například okraje apod.).

Dark grey, grey, clear, extra clear and bronze colors are stained glass in the mass. Other colors are glass frits (powders) and can be used also partly on the product (for example on the rim only).

Technologie lehaného skla | Technology fusing





Kontakt:

BDK-GLASS, spol. s r.o.

Ed. Karla 72 | 503 03 Smiřice | Czech Republic

Tel.: +420 495 421 271

E-mail: bdk@bdk.cz | www.bdk.cz | www.krasne-sklo.cz